

**Product Summary (@T<sub>A</sub> = +25°C)**

P <sub>PK</sub>	I <sub>FSM</sub> (A)	V <sub>RWM</sub> (V)	PM <sub>(AV)</sub>
6600W	700	10 to 43	8W

**Features and Benefits**

- 6600W Peak Pulse Power Dissipation
- T<sub>J</sub> = +175°C Capability Suitable for High Reliability and Automotive Requirement
- High Current Capability
- Glass Passivated Die Construction
- Excellent High-Temperature Stability
- Meets ISO7637-2 Surge Capability
- Meets ISO16750-2 Surge Specification
- **Lead-Free Finish; RoHS Compliant (Notes 1 & 2)**
- **Halogen and Antimony Free. "Green" Device (Note 3)**
- **The DM8W10AQ-DM8W43AQ are suitable for automotive applications requiring specific change control; these parts are AEC-Q101 qualified, PPAP capable, and manufactured in IATF 16949 certified facilities.**  
<https://www.diodes.com/quality/product-definitions/>

**Description and Applications**

Suitable to protect sensitive automotive circuits against surges defined in ISO7637-2 and against load-dump surge according to ISO16750-2.

Compliance with following standards:

- ISO 16750-2, Pulse A and Pulse B
- ISO 7637-2 (Note 5)  
Pulse 1, Pulse 2a, Pulse 3a, Pulse 3b

**Mechanical Data**

- Case: DO-218 (Type E)
- Case Material: Molded Plastic.  
UL Flammability Classification Rating 94V-0
- Moisture Sensitivity: Level 1 per J-STD-020
- Terminals: Lead-Free Plating (Matte Tin Finish).  
Solderable per MIL-STD-202, Method 208 @3
- Polarity Indicator: Heatsink is Anode
- Weight: 2.74 grams (Approximate)

DO-218 (Type E)

Polarity: Heatsink is Anode



Top View

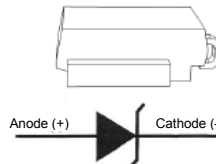

Pin Information

**Ordering Information (Note 4)**

Part Number	Qualification	Case	Packaging
DM8WxxAQ-13	Automotive	DO-218 (Type E)	750/Tape & Reel

\*x = Device Voltage, e.g., DM8W18AQ-13

- Notes:
1. EU Directive 2002/95/EC (RoHS), 2011/65/EU (RoHS 2) & 2015/863/EU (RoHS 3) compliant. All applicable RoHS exemptions applied.
  2. See <https://www.diodes.com/quality/lead-free/> for more information about Diodes Incorporated's definitions of Halogen- and Antimony-free, "Green" and Lead-free.
  3. Halogen- and Antimony-free "Green" products are defined as those which contain <900ppm bromine, <900ppm chlorine (<1500ppm total Br + Cl) and <1000ppm antimony compounds.
  4. For packaging details, go to our website at <https://www.diodes.com/design/support/packaging/diodes-packaging/>.
  5. Not applicable to parts with stand-off voltage lower than the average battery voltage (13.5V).

**Marking Information**

M8WxxA = Product Type Marking Code (i.e. M8W18A for DM8W18AQ-13)  
 ⌋⌋ = Manufacturers' Code Marking  
 YWW = Date Code Marking  
 Y = Last Digit of Year (ex: 0 for 2020)  
 WW = Week Code (01 to 53)  
 Bar Denotes Cathode Pin, Circle Denotes Anode

**Maximum Ratings** (@T<sub>A</sub> = +25°C, unless otherwise specified.)

Characteristic	Symbol	Value	Unit
Peak Pulse Power Dissipation (Non Repetitive Current Pulse Derated above T <sub>A</sub> = +25°C) (Note 6)	10/1000µs Waveform	6600	W
	10/10000µs Waveform	5200	
Peak Forward Surge Current, 8.3ms Single Half Sine-Wave Superimposed on Rated Load (Note 7)	I <sub>FSM</sub>	700	A
Steady State Power Dissipation @ T <sub>C</sub> = +25°C	PM <sub>(AV)</sub>	8.0	W

**Thermal Characteristics**

Characteristic	Symbol	Value	Unit
Typical Thermal Resistance, Junction to Case	R <sub>θJC</sub>	0.9	°C/W
Operating Temperature Range	T <sub>J</sub>	-55 to +175	°C
Storage Temperature Range	T <sub>STG</sub>	-55 to +175	°C

- Notes: 6. Valid provided that terminals are kept at ambient temperature.  
7. Measured on 8.3ms single half sine-wave or equivalent square wave. Duty cycle = 4 pulses per minute maximum.

**Electrical Characteristics** (@T<sub>A</sub> = +25°C, unless otherwise specified.)

Part Number	Reverse Standoff Voltage	Breakdown Voltage V <sub>BR</sub> @ I <sub>T</sub> (Note 8)		Test Current	Max. Reverse Leakage @ V <sub>RWM</sub> (Note 10)	Max. Clamping Voltage @ I <sub>pp</sub>	Max. Peak Pulse Current I <sub>pp</sub> at 10/1000µs (Note 9)	Maximum Leakage at V <sub>WM</sub> T <sub>J</sub> = +175°C
	V <sub>RWM</sub> (V)	Min (V)	Max (V)	I <sub>T</sub> (mA)	I <sub>R</sub> (µA)	V <sub>C</sub> (V)	(A)	I <sub>D</sub> (µA)
DM8W10AQ	10	11.1	12.3	5	15	17.0	388	250
DM8W11AQ	11	12.2	13.5	5	10	18.2	363	150
DM8W12AQ	12	13.3	14.7	5	10	19.9	332	150
DM8W13AQ	13	14.4	15.9	5	10	21.5	307	150
DM8W14AQ	14	15.6	17.2	5	10	23.2	284	150
DM8W15AQ	15	16.7	18.5	5	10	24.4	270	150
DM8W16AQ	16	17.8	19.7	5	10	26.0	254	150
DM8W17AQ	17	18.9	20.9	5	10	27.6	239	150
DM8W18AQ	18	20.0	22.1	5	10	29.2	226	150
DM8W20AQ	20	22.2	24.5	5	10	32.4	204	150
DM8W22AQ	22	24.4	26.9	5	10	35.5	186	150
DM8W24AQ	24	26.7	29.5	5	10	38.9	170	150
DM8W26AQ	26	28.9	31.9	5	10	42.1	157	150
DM8W28AQ	28	31.1	34.4	5	10	45.4	145	150
DM8W30AQ	30	33.3	36.8	5	10	48.4	136	150
DM8W33AQ	33	36.7	40.6	5	10	53.3	124	150
DM8W36AQ	36	40.0	44.2	5	10	58.1	114	150
DM8W40AQ	40	44.4	49.1	5	10	64.5	102	150
DM8W43AQ	43	47.8	52.8	5	10	69.4	95.1	150

- Notes: 8. V<sub>BR</sub> measured with I<sub>T</sub> current pulse = 10ms to 15ms.  
9. Per 10 × 1000µs waveform. See Figure 3.  
10. Short duration pulse test used so as to minimize the self-heating effect.

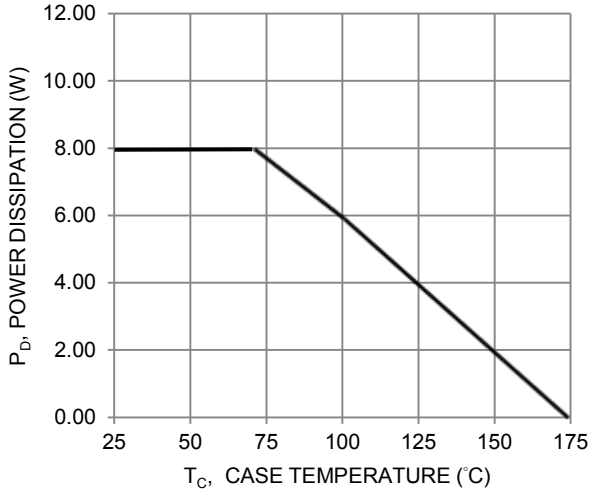

Fig. 1 Power Derating Curve

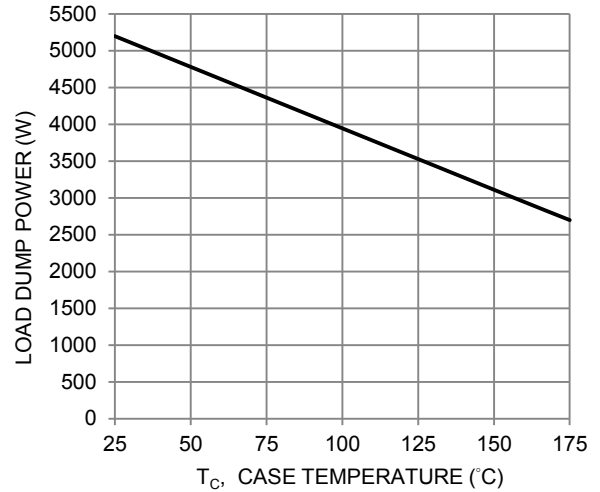

Fig. 2 Load Dump Power Characteristics (10ms Exponential Waveform)

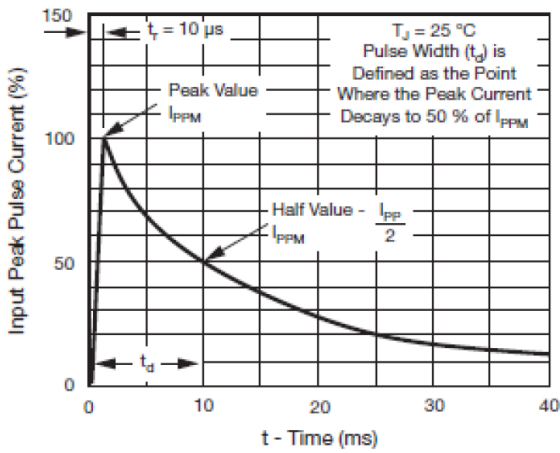

Fig. 3 - Pulse Waveform

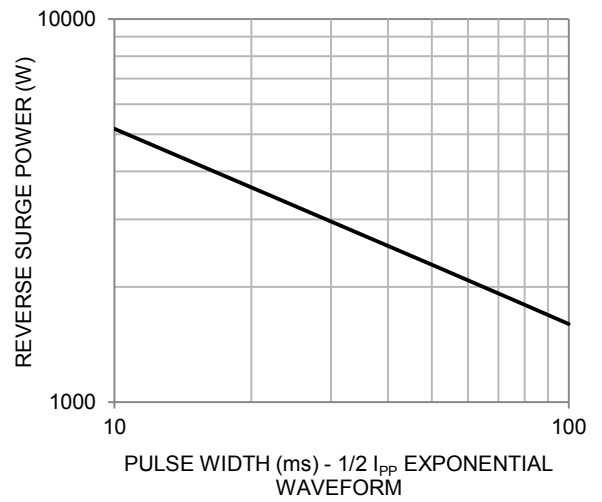

Fig. 4 Reverse Power Capability

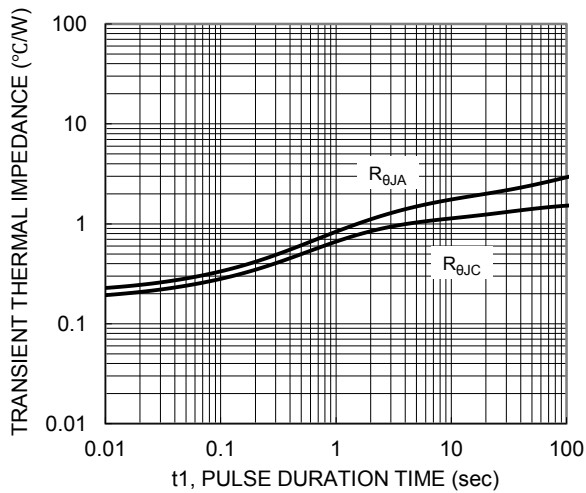

Fig. 5 Typical Transient Thermal Impedance

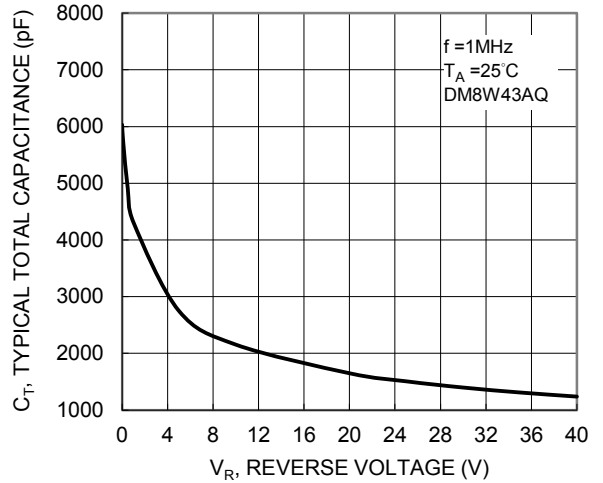
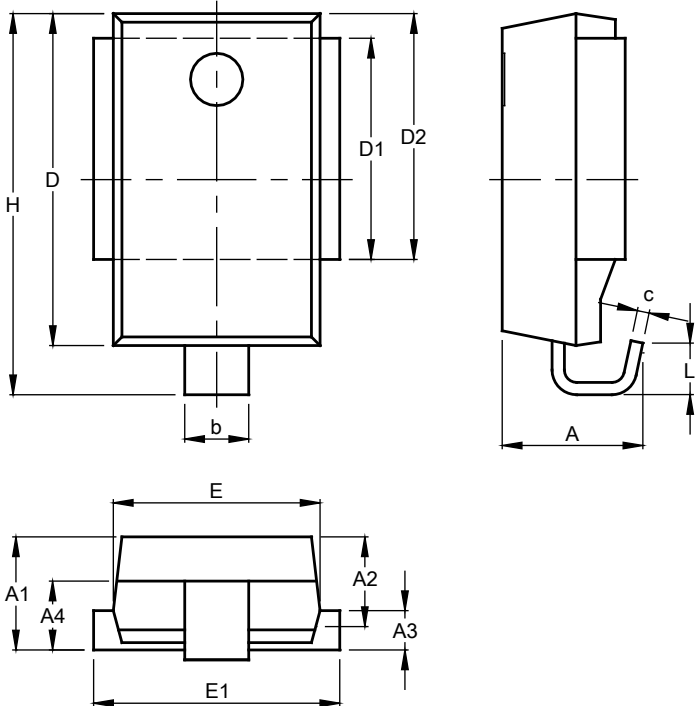

Fig. 6 Typical Total Capacitance (DM8W43AQ Only)

**Package Outline Dimensions**

Please see <http://www.diodes.com/package-outlines.html> for the latest version.

**DO-218 (Type E)**



DO-218 (Type E)			
Dim	Min	Max	Typ
A	4.70	5.70	--
A1	4.70	5.25	5.00
A2	3.45	4.25	3.95
A3	1.70	2.50	2.00
A4	2.65	3.55	3.10
b	2.30	3.00	--
c	0.45	0.90	--
D	13.20	13.80	13.50
D1	8.70	9.30	9.00
D2	9.70	10.30	10.00
E	8.20	8.80	8.50
E1	9.50	10.00	--
H	15.00	16.00	15.50
L	1.50	2.50	2.00
All Dimensions in mm			

**Suggested Pad Layout**

Please see <http://www.diodes.com/package-outlines.html> for the latest version.

**DO-218 (Type E)**

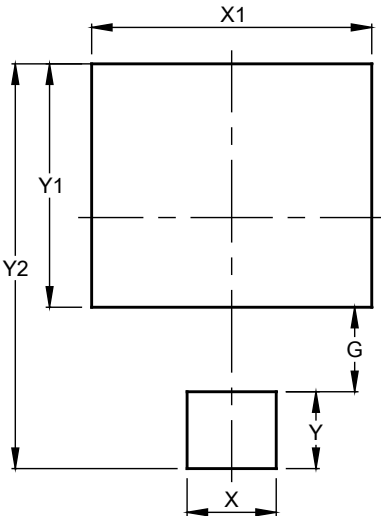

Dimensions	Value (in mm)
G	3.30
X	3.50
X1	11.00
Y	3.00
Y1	9.50
Y2	15.80

**IMPORTANT NOTICE**

DIODES INCORPORATED MAKES NO WARRANTY OF ANY KIND, EXPRESS OR IMPLIED, WITH REGARDS TO THIS DOCUMENT, INCLUDING, BUT NOT LIMITED TO, THE IMPLIED WARRANTIES OF MERCHANTABILITY AND FITNESS FOR A PARTICULAR PURPOSE (AND THEIR EQUIVALENTS UNDER THE LAWS OF ANY JURISDICTION).

Diodes Incorporated and its subsidiaries reserve the right to make modifications, enhancements, improvements, corrections or other changes without further notice to this document and any product described herein. Diodes Incorporated does not assume any liability arising out of the application or use of this document or any product described herein; neither does Diodes Incorporated convey any license under its patent or trademark rights, nor the rights of others. Any Customer or user of this document or products described herein in such applications shall assume all risks of such use and will agree to hold Diodes Incorporated and all the companies whose products are represented on Diodes Incorporated website, harmless against all damages.

Diodes Incorporated does not warrant or accept any liability whatsoever in respect of any products purchased through unauthorized sales channel. Should Customers purchase or use Diodes Incorporated products for any unintended or unauthorized application, Customers shall indemnify and hold Diodes Incorporated and its representatives harmless against all claims, damages, expenses, and attorney fees arising out of, directly or indirectly, any claim of personal injury or death associated with such unintended or unauthorized application.

Products described herein may be covered by one or more United States, international or foreign patents pending. Product names and markings noted herein may also be covered by one or more United States, international or foreign trademarks.

This document is written in English but may be translated into multiple languages for reference. Only the English version of this document is the final and determinative format released by Diodes Incorporated.

**LIFE SUPPORT**

Diodes Incorporated products are specifically not authorized for use as critical components in life support devices or systems without the express written approval of the Chief Executive Officer of Diodes Incorporated. As used herein:

A. Life support devices or systems are devices or systems which:

1. are intended to implant into the body, or
2. support or sustain life and whose failure to perform when properly used in accordance with instructions for use provided in the labeling can be reasonably expected to result in significant injury to the user.

B. A critical component is any component in a life support device or system whose failure to perform can be reasonably expected to cause the failure of the life support device or to affect its safety or effectiveness.

Customers represent that they have all necessary expertise in the safety and regulatory ramifications of their life support devices or systems, and acknowledge and agree that they are solely responsible for all legal, regulatory and safety-related requirements concerning their products and any use of Diodes Incorporated products in such safety-critical, life support devices or systems, notwithstanding any devices- or systems-related information or support that may be provided by Diodes Incorporated. Further, Customers must fully indemnify Diodes Incorporated and its representatives against any damages arising out of the use of Diodes Incorporated products in such safety-critical, life support devices or systems.

Copyright © 2020, Diodes Incorporated

[www.diodes.com](http://www.diodes.com)

单击下面可查看定价，库存，交付和生命周期等信息

[>>Diodes Incorporated\(达尔科技\)](#)