

Product Summary

Device	BV _{DSS}	R _{DS(ON)} Max	I _D T _A = +25°C
Q1	60V	13.5Ω @ V _{GS} = 10V	115mA
Q2	-50V	10Ω @ V _{GS} = -5V	-130mA

Description

This MOSFET has been designed to minimize the on-state resistance (R_{DS(ON)}) and yet maintain superior switching performance, making it ideal for high efficiency power management applications.

Applications

- General Purpose Interfacing Switch
- Power Management Functions
- Analog Switch

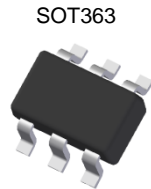

Top View

Features and Benefits

- Low On-Resistance
- Low Gate Threshold Voltage
- Low Input Capacitance
- Fast Switching Speed
- Low Input/Output Leakage
- Complementary Pair
- **Totally Lead-Free & Fully RoHS Compliant (Notes 1 & 2)**
- **Halogen and Antimony Free. "Green" Device (Note 3)**
- **The BSS8402DWQ is suitable for automotive applications requiring specific change control; this part is AEC-Q101 qualified, PPAP capable, and manufactured in IATF 16949 certified facilities.**
<https://www.diodes.com/quality/product-definitions/>

Mechanical Data

- Case: SOT363
- Case Material: Molded Plastic. "Green" Molding Compound. UL Flammability Classification Rating 94V-0
- Moisture Sensitivity: Level 1 per J-STD-020
- Terminals: Matte Tin Finish Annealed over Alloy 42 Leadframe (Lead Free Plating). Solderable per MIL-STD-202, Method 208 **e3**
- Terminal Connections: See Diagram
- Weight: 0.006 grams (Approximate)

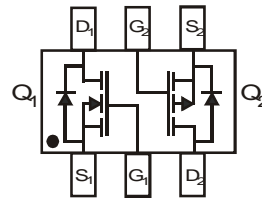

Top View
Internal Schematic

Ordering Information (Note 4)

Part Number	Compliance	Case	Packaging
BSS8402DW-7-F	Standard	SOT363	3,000/Tape & Reel
BSS8402DW-13-F	Standard	SOT363	10,000/Tape & Reel
BSS8402DWQ-7	Automotive	SOT363	3,000/Tape & Reel
BSS8402DWQ-13	Automotive	SOT363	10,000/Tape & Reel

- Notes:
1. No purposely added lead. Fully EU Directive 2002/95/EC (RoHS), 2011/65/EU (RoHS 2) & 2015/863/EU (RoHS 3) compliant.
 2. See <https://www.diodes.com/quality/lead-free/> for more information about Diodes Incorporated's definitions of Halogen- and Antimony-free, "Green" and Lead-free.
 3. Halogen- and Antimony-free "Green" products are defined as those which contain <900ppm bromine, <900ppm chlorine (<1500ppm total Br + Cl) and <1000ppm antimony compounds.
 4. For packaging details, go to our website at <https://www.diodes.com/design/support/packaging/diodes-packaging/>.

Marking Information

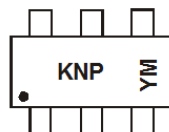

KNP = Product Type Marking Code
 YM or YM = Date Code Marking
 Y or Y = Year (ex: G = 2019)
 M = Month (ex: 9 = September)

Date Code Key

Year	2003	2004	2005	2006	~	2018	2019	2020	2021	2022	2023	2024	2025	2026
Code	P	R	S	T	~	F	G	H	I	J	K	L	M	N

Month	Jan	Feb	Mar	Apr	May	Jun	Jul	Aug	Sep	Oct	Nov	Dec
Code	1	2	3	4	5	6	7	8	9	O	N	D

Maximum Ratings – Total Device (@T_A = +25°C, unless otherwise specified.)

Characteristic	Symbol	Value	Unit
Power Dissipation (Note 5)	P _D	200	mW
Thermal Resistance, Junction to Ambient	R _{θJA}	625	°C/W
Operating and Storage Temperature Range	T _J , T _{STG}	-55 to +150	°C

Maximum Ratings N-CHANNEL – Q₁, 2N7002 Section (@T_A = +25°C, unless otherwise specified.)

Characteristic	Symbol	Value	Unit
Drain-Source Voltage	V _{DSS}	60	V
Drain-Gate Voltage R _{GS} ≤ 1.0MΩ	V _{DGR}	60	V
Gate-Source Voltage	V _{GSS}	±20	V
Continuous Pulsed		±40	
Drain Current (Note 5)	I _D	Continuous	115
		Continuous @ +100°C	73
		Pulsed	800

Maximum Ratings P-CHANNEL – Q₂, BSS84 Section (@T_A = +25°C, unless otherwise specified.)

Characteristic	Symbol	Value	Unit
Drain-Source Voltage	V _{DSS}	-50	V
Drain-Gate Voltage R _{GS} ≤ 20KΩ	V _{DGR}	-50	V
Gate-Source Voltage	V _{GSS}	±20	V
Drain Current (Note 5)	I _D	-130	mA

Note: 5. Device mounted on FR-4 PCB, 1 inch x 0.85 inch x 0.062 inch; pad layout as shown on Diodes Incorporated's suggested pad layout document, which can be found on our website at <http://www.diodes.com/package-outlines.html>.

Electrical Characteristics N-CHANNEL – Q₁, 2N7002 Section (@T_A = +25°C, unless otherwise specified.)

Characteristic	Symbol	Min	Typ	Max	Unit	Test Condition
OFF CHARACTERISTICS (Note 6)						
Drain-Source Breakdown Voltage	BV _{DSS}	60	70	—	V	V _{GS} = 0V, I _D = 10μA
Zero Gate Voltage Drain Current	I _{DSS}	—	—	1.0 500	μA	@ T _C = +25°C @ T _C = +125°C V _{DS} = 60V, V _{GS} = 0V
Gate-Body Leakage	I _{GSS}	—	—	±10	nA	V _{GS} = ±20V, V _{DS} = 0V
ON CHARACTERISTICS (Note 6)						
Gate Threshold Voltage	V _{GS(TH)}	1.0	—	2.5	V	V _{DS} = V _{GS} , I _D = 250μA
Static Drain-Source On-Resistance	R _{DS(ON)}	—	3.2 4.4	7.5 13.5	Ω	@ T _J = +25°C @ T _J = +125°C V _{GS} = 5.0V, I _D = 0.05A V _{GS} = 10V, I _D = 0.5A
On-State Drain Current	I _{D(ON)}	0.5	1.0	—	A	V _{GS} = 10V, V _{DS} = 7.5V
Forward Transconductance	g _{FS}	80	—	—	mS	V _{DS} = 10V, I _D = 0.2A
DYNAMIC CHARACTERISTICS						
Input Capacitance	C _{iSS}	—	22	50	pF	V _{DS} = 25V, V _{GS} = 0V, f = 1.0MHz
Output Capacitance	C _{oSS}	—	11	25	pF	
Reverse Transfer Capacitance	C _{rSS}	—	2.0	5.0	pF	
SWITCHING CHARACTERISTICS						
Turn-On Delay Time	t _{D(ON)}	—	7.0	20	ns	V _{DD} = 30V, I _D = 0.2A, R _L = 150Ω, V _{GEN} = 10V, R _{GEN} = 25Ω
Turn-Off Delay Time	t _{D(OFF)}	—	11	20	ns	

Electrical Characteristics P-CHANNEL – Q₂, BSS84 Section (@T_A = +25°C, unless otherwise specified.)

Characteristic	Symbol	Min	Typ	Max	Unit	Test Condition
OFF CHARACTERISTICS (Note 6)						
Drain-Source Breakdown Voltage	BV _{DSS}	-50	—	—	V	V _{GS} = 0V, I _D = -250μA
Zero Gate Voltage Drain Current	I _{DSS}	—	—	-1 -2 -100	μA μA nA	V _{DS} = -50V, V _{GS} = 0V, T _J = +25°C V _{DS} = -50V, V _{GS} = 0V, T _J = +125°C V _{DS} = -25V, V _{GS} = 0V, T _J = +25°C
Gate-Body Leakage	I _{GSS}	—	—	±10	nA	V _{GS} = ±20V, V _{DS} = 0V
ON CHARACTERISTICS (Note 6)						
Gate Threshold Voltage	V _{GS(TH)}	-0.8	—	-2.0	V	V _{DS} = V _{GS} , I _D = -1mA
Static Drain-Source On-Resistance	R _{DS(ON)}	—	—	10	Ω	V _{GS} = -5V, I _D = -0.100A
Forward Transconductance	g _{FS}	0.05	—	—	S	V _{DS} = -25V, I _D = -0.1A
DYNAMIC CHARACTERISTICS						
Input Capacitance	C _{iSS}	—	—	45	pF	V _{DS} = -25V, V _{GS} = 0V, f = 1.0MHz
Output Capacitance	C _{oSS}	—	—	25	pF	
Reverse Transfer Capacitance	C _{rSS}	—	—	12	pF	
SWITCHING CHARACTERISTICS						
Turn-On Delay Time	t _{D(ON)}	—	10	—	ns	V _{DD} = -30V, I _D = -0.27A, R _{GEN} = 50Ω, V _{GS} = -10V
Turn-Off Delay Time	t _{D(OFF)}	—	18	—	ns	

Note: 6. Short duration pulse test used to minimize self-heating effect.

N-CHANNEL – 2N7002 Section

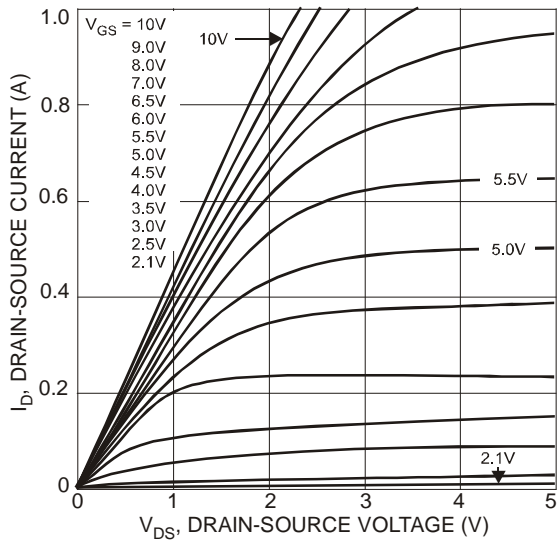

Figure 1 On-Region Characteristics

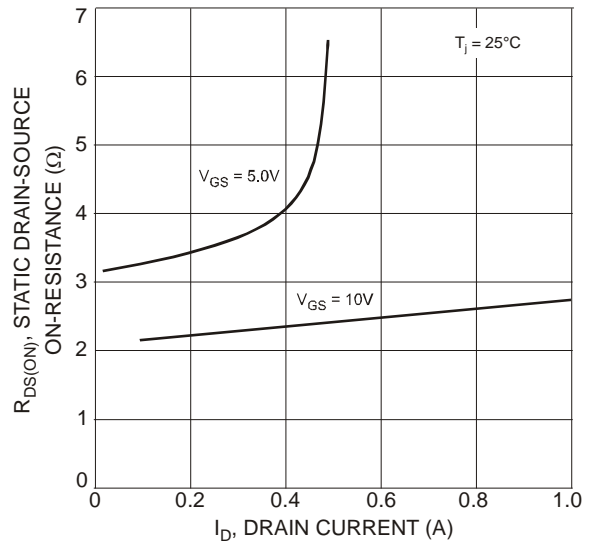

Figure 2 On-Resistance vs. Drain Current

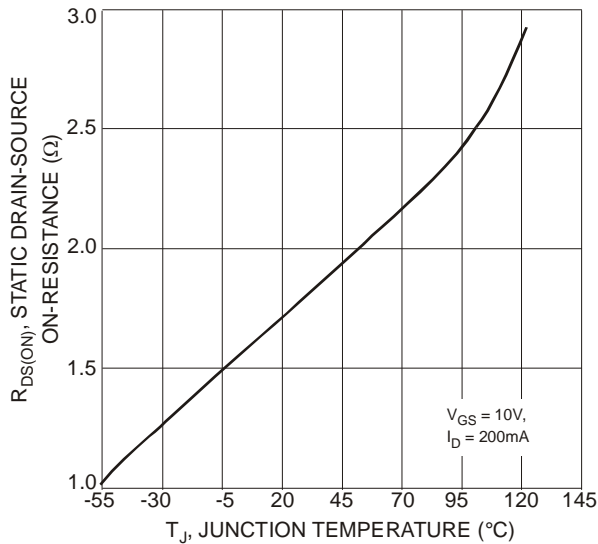

Figure 3 On-Resistance vs. Junction Temperature

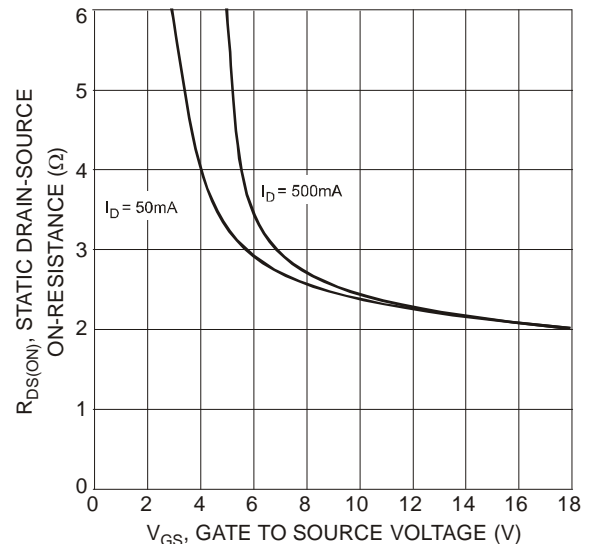

Figure 4 On-Resistance vs. Gate-Source Voltage

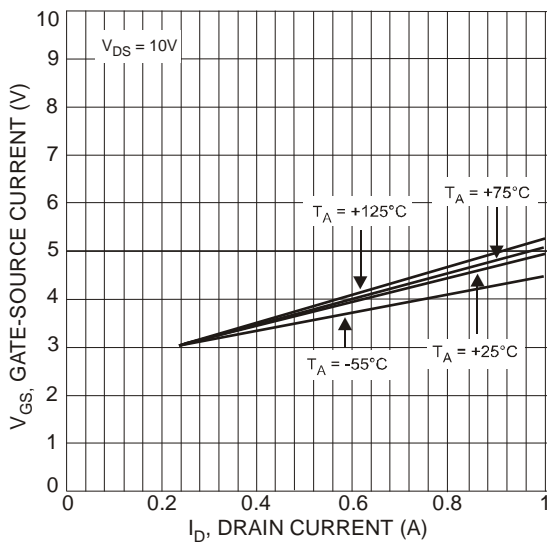

Figure 5 Typical Transfer Characteristics

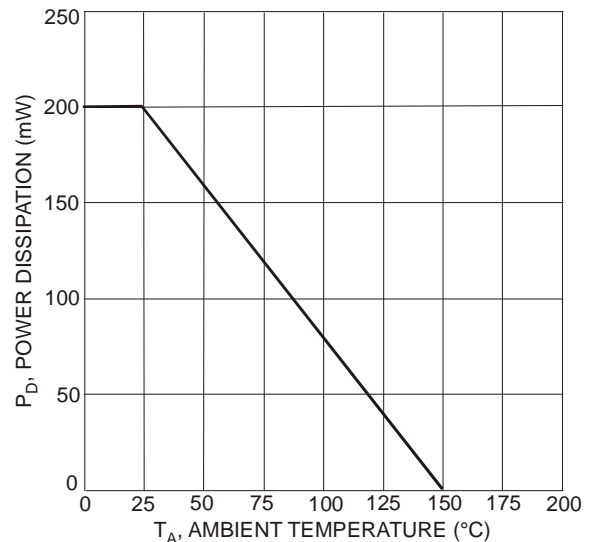

Figure 6 Max Power Dissipation vs. Ambient Temperature

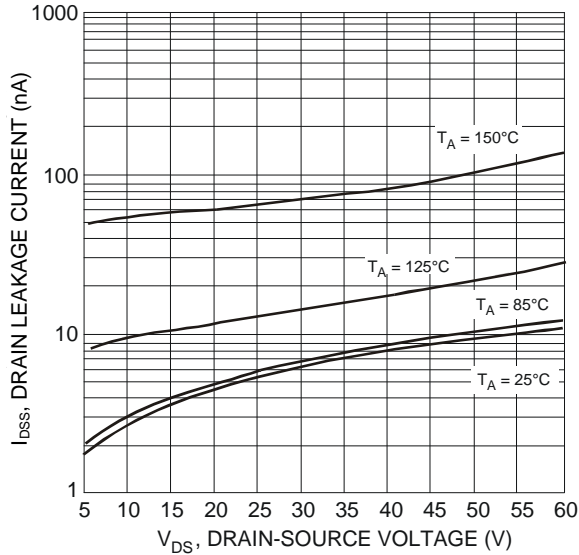

Figure 7 Typical Drain-Source Leakage Current vs. Voltage

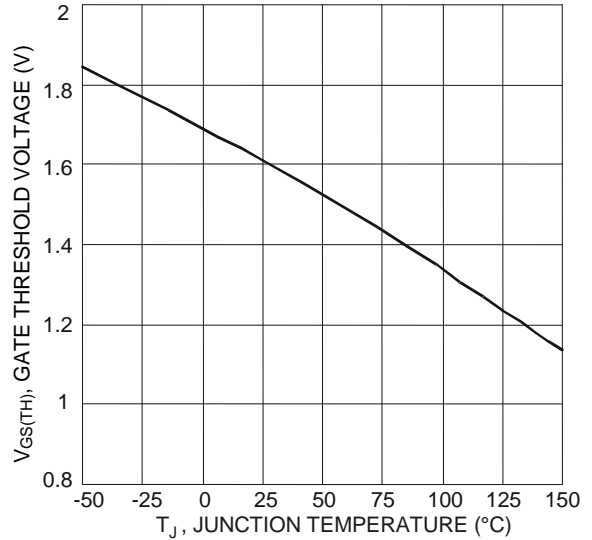

Figure 8 Gate Threshold Variation vs. Junction Temperature

P-CHANNEL – BSS84 Section

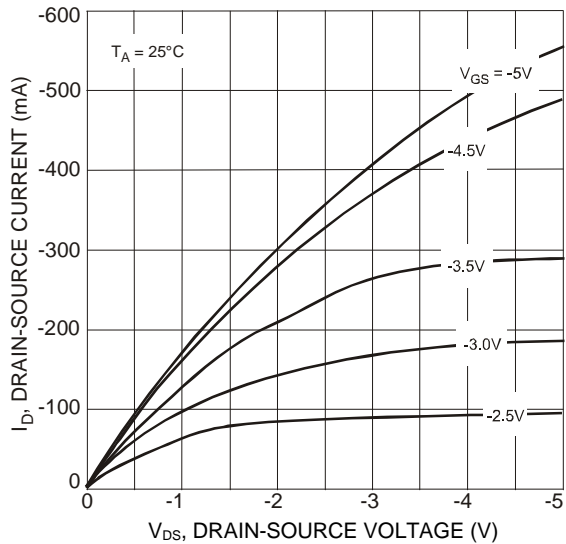

Figure 9 Drain-Source Current vs. Drain-Source Voltage

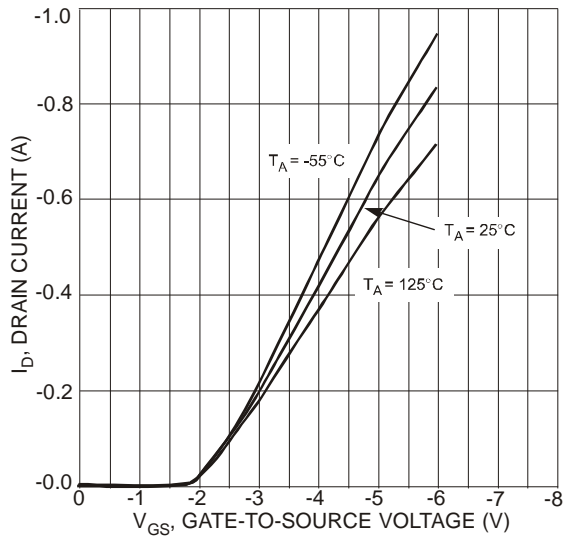

Figure 10 Drain Current vs. Gate-Source Voltage

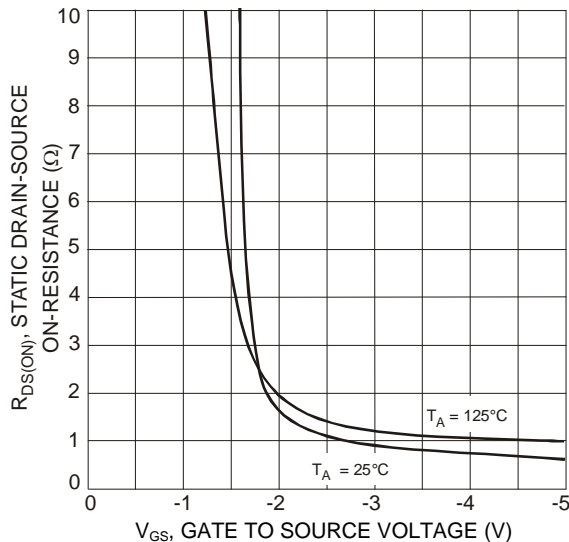

Figure 11 On-Resistance vs. Gate-Source Voltage

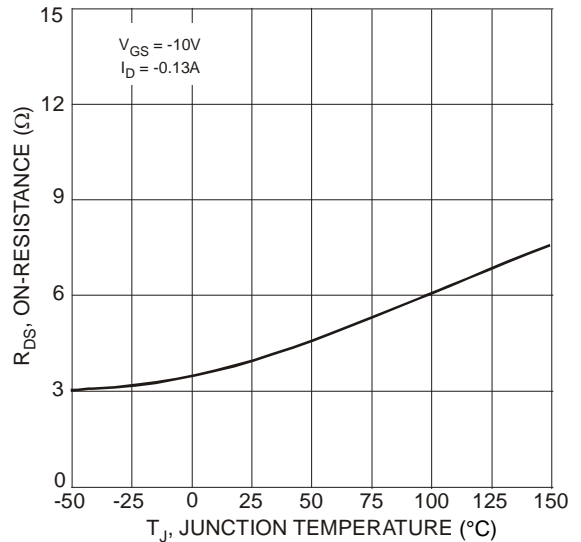

Figure 12 On-Resistance vs. Junction Temperature

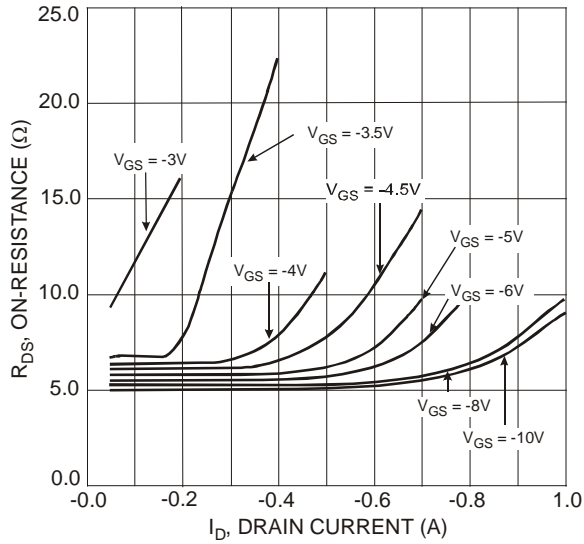

Figure 13 On-Resistance vs. Drain Current

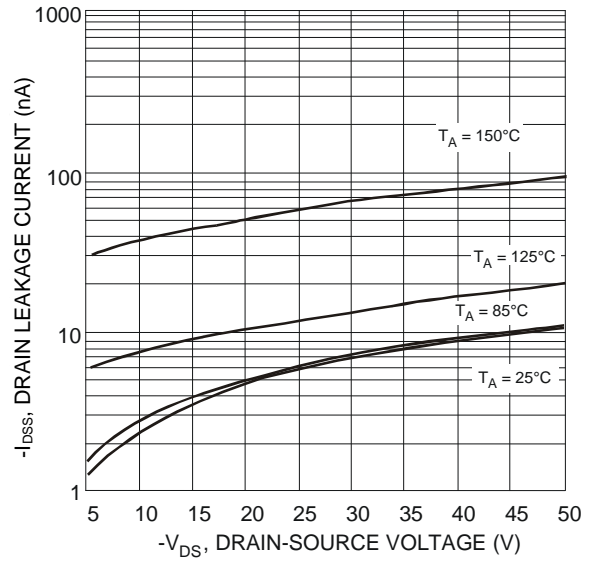

Figure 14 Typical Drain-Source Leakage Current vs. Voltage

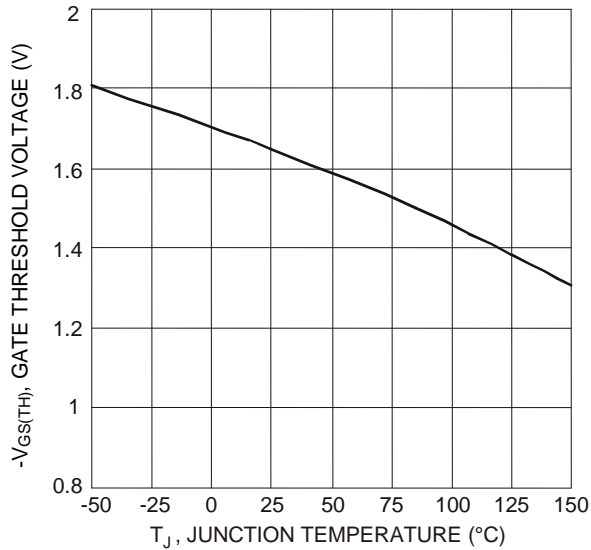
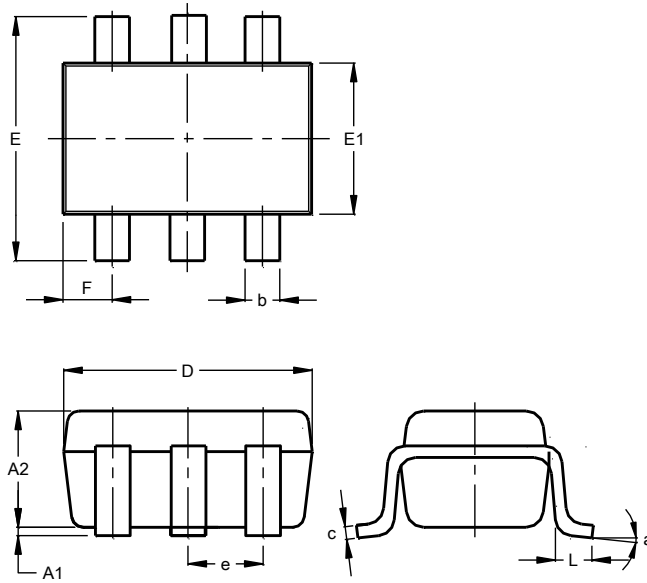

Figure 15 Gate Threshold Variation vs. Junction Temperature

Package Outline Dimensions

Please see <http://www.diodes.com/package-outlines.html> for the latest version.

SOT363



SOT363			
Dim	Min	Max	Typ
A1	0.00	0.10	0.05
A2	0.90	1.00	0.95
b	0.10	0.30	0.25
c	0.10	0.22	0.11
D	1.80	2.20	2.15
E	2.00	2.20	2.10
E1	1.15	1.35	1.30
e	0.650 BSC		
F	0.40	0.45	0.425
L	0.25	0.40	0.30
a	0°	8°	--
All Dimensions in mm			

Suggested Pad Layout

Please see <http://www.diodes.com/package-outlines.html> for the latest version.

SOT363

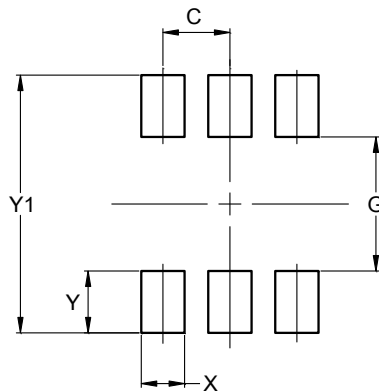

Dimensions	Value (in mm)
C	0.650
G	1.300
X	0.420
Y	0.600
Y1	2.500

IMPORTANT NOTICE

DIODES INCORPORATED MAKES NO WARRANTY OF ANY KIND, EXPRESS OR IMPLIED, WITH REGARDS TO THIS DOCUMENT, INCLUDING, BUT NOT LIMITED TO, THE IMPLIED WARRANTIES OF MERCHANTABILITY AND FITNESS FOR A PARTICULAR PURPOSE (AND THEIR EQUIVALENTS UNDER THE LAWS OF ANY JURISDICTION).

Diodes Incorporated and its subsidiaries reserve the right to make modifications, enhancements, improvements, corrections or other changes without further notice to this document and any product described herein. Diodes Incorporated does not assume any liability arising out of the application or use of this document or any product described herein; neither does Diodes Incorporated convey any license under its patent or trademark rights, nor the rights of others. Any Customer or user of this document or products described herein in such applications shall assume all risks of such use and will agree to hold Diodes Incorporated and all the companies whose products are represented on Diodes Incorporated website, harmless against all damages.

Diodes Incorporated does not warrant or accept any liability whatsoever in respect of any products purchased through unauthorized sales channel. Should Customers purchase or use Diodes Incorporated products for any unintended or unauthorized application, Customers shall indemnify and hold Diodes Incorporated and its representatives harmless against all claims, damages, expenses, and attorney fees arising out of, directly or indirectly, any claim of personal injury or death associated with such unintended or unauthorized application.

Products described herein may be covered by one or more United States, international or foreign patents pending. Product names and markings noted herein may also be covered by one or more United States, international or foreign trademarks.

This document is written in English but may be translated into multiple languages for reference. Only the English version of this document is the final and determinative format released by Diodes Incorporated.

LIFE SUPPORT

Diodes Incorporated products are specifically not authorized for use as critical components in life support devices or systems without the express written approval of the Chief Executive Officer of Diodes Incorporated. As used herein:

A. Life support devices or systems are devices or systems which:

1. are intended to implant into the body, or
2. support or sustain life and whose failure to perform when properly used in accordance with instructions for use provided in the labeling can be reasonably expected to result in significant injury to the user.

B. A critical component is any component in a life support device or system whose failure to perform can be reasonably expected to cause the failure of the life support device or to affect its safety or effectiveness.

Customers represent that they have all necessary expertise in the safety and regulatory ramifications of their life support devices or systems, and acknowledge and agree that they are solely responsible for all legal, regulatory and safety-related requirements concerning their products and any use of Diodes Incorporated products in such safety-critical, life support devices or systems, notwithstanding any devices- or systems-related information or support that may be provided by Diodes Incorporated. Further, Customers must fully indemnify Diodes Incorporated and its representatives against any damages arising out of the use of Diodes Incorporated products in such safety-critical, life support devices or systems.

Copyright © 2019, Diodes Incorporated

www.diodes.com

单击下面可查看定价，库存，交付和生命周期等信息

[>>Diodes Incorporated\(达尔科技\)](#)