

Product Summary

BV_{DSS}	$R_{DS(ON)}$	I_D $T_A = +25^\circ C$
-20V	200mΩ @ $V_{GS} = -4.5V$	-2.3A

Description

This new generation of high density MOSFETs from Zetex utilizes a unique structure that combines the benefits of low on-resistance with fast switching speed. This makes them ideal for high efficiency, low voltage, power management applications.

Applications

- DC - DC Converters
- Power Management Functions
- Disconnect Switches
- Motor Control

Features and Benefits

- Low On-resistance
- Fast Switching Speed
- Low Threshold
- Low Gate Drive
- **Totally Lead-Free & Fully RoHS Compliant (Notes 1 & 2)**
- **Halogen and Antimony Free. "Green" Device (Note 3)**

Mechanical Data

- Case: SOT26
- Case Material: Molded Plastic, "Green" Molding Compound. UL Flammability Classification Rating 94V-0
- Moisture Sensitivity: Level 1 per J-STD-020
- Terminals Connections: See Diagram Below
- Terminals: Finish - Matte Tin Annealed over Copper Leadframe. Solderable per MIL-STD-202, Method 208
- Weight: 0.018 grams (Approximate)

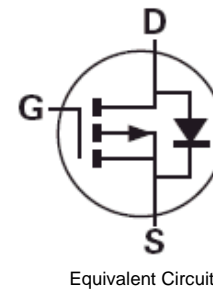
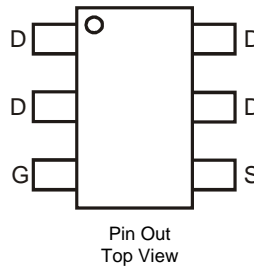

Ordering Information (Note 4)

Part Number	Reel Size (inch)	Tape Width (mm)	Quantity Per Reel
ZXM62P02E6TA	7	8	3,000
ZXM62P02E6TC	13	8	10,000

- Notes:
1. No purposely added lead. Fully EU Directive 2002/95/EC (RoHS) & 2011/65/EU (RoHS 2) compliant.
 2. See http://www.diodes.com/quality/lead_free.html for more information about Diodes Incorporated's definitions of Halogen- and Antimony-free, "Green" and Lead-free.
 3. Halogen- and Antimony-free "Green" products are defined as those which contain <900ppm bromine, <900ppm chlorine (<1500ppm total Br + Cl) and <1000ppm antimony compounds.
 4. For packaging details, go to our website at <http://www.diodes.com/products/packages.html>.

Marking Information

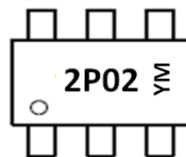

2P02 = Product Type Marking Code
 YM = Date Code Marking
 Y or \bar{Y} = Year (ex: C = 2015)
 M or \bar{M} = Month (ex: 9 = September)

Date Code Key

Year	2015	2016	2017	2018	2019	2020	2021	2022	2023	2024	2025	2026
Code	C	D	E	F	G	H	I	J	K	L	M	N

Month	Jan	Feb	Mar	Apr	May	Jun	Jul	Aug	Sep	Oct	Nov	Dec
Code	1	2	3	4	5	6	7	8	9	O	N	D

Absolute Maximum Ratings

Characteristic		Symbol	Value	Unit	
Drain-Source Voltage		V_{DSS}	-20	V	
Gate-Source Voltage		V_{GSS}	± 12	V	
Continuous Drain Current	$V_{GS} = -4.5V$	I_D	$T_A = +25^\circ C$ (Note 6)	-2.3	A
			$T_A = +70^\circ C$ (Note 6)	-1.7	
Pulsed Drain Current		(Note 7)	I_{DM}	-13	A
Continuous Source Current (Body Diode)		(Note 6)	I_S	-1.9	A
Pulsed Source Current (Body Diode)		(Note 7)	I_{SM}	-13	A
Power Dissipation at $T_A = +25^\circ C$		(Note 5)	P_D	1.1	W
Linear Derating Factor				8.8	
Power Dissipation at $T_A = +25^\circ C$		(Note 6)	P_D	1.7	W
Linear Derating Factor				13.7	
Operating and Storage Temperature Range		T_J, T_{STG}	-55 to +150	$^\circ C$	

Thermal Resistance

Characteristic		Symbol	Value	Unit
Junction to Ambient	(Note 5)	$R_{\theta JA}$	113	$^\circ C/W$
	(Note 6)		73	

Electrical Characteristics (@ $T_A = +25^\circ C$, unless otherwise stated.)

Characteristic	Symbol	Min	Typ	Max	Unit	Test Condition
STATIC						
Drain-Source Breakdown Voltage	BV_{DSS}	-20	—	—	V	$I_D = -250\mu A, V_{GS} = 0V$
Zero Gate Voltage Drain Current	I_{DSS}	—	—	-1	μA	$V_{DS} = -20V, V_{GS} = 0V$
Gate-Source Leakage	I_{GSS}	—	—	± 100	nA	$V_{GS} = \pm 12V, V_{DS} = 0V$
Gate Threshold Voltage	$V_{GS(TH)}$	-0.7	—	—	V	$I_D = -250\mu A, V_{DS} = V_{GS}$
Static Drain-Source On-Resistance (Note 8)	$R_{DS(ON)}$	—	—	0.2	Ω	$V_{GS} = -4.5V, I_D = -1.6A$
				0.375		$V_{GS} = -2.7V, I_D = -0.8A$
Forward Transconductance (Note 10)	g_{fs}	1.5	—	—	S	$V_{DS} = -10V, I_D = -0.8A$
DYNAMIC (Note 10)						
Input Capacitance	C_{iss}	—	320	—	pF	$V_{DS} = -15V, V_{GS} = 0V$ $f = 1MHz$
Output Capacitance	C_{oss}	—	150	—	pF	
Reverse Transfer Capacitance	C_{rss}	—	75	—	pF	
SWITCHING (Notes 9 and 10)						
Total Gate Charge	Q_g	—	—	5.8	nC	$V_{DS} = -16V, V_{GS} = -4.5V$ $I_D = -1.6A$ (Refer to test circuit)
Gate-Source Charge	Q_{gs}	—	—	1.25	nC	
Gate-Drain Charge	Q_{gd}	—	—	2.8	nC	
Turn-On Delay Time	$t_{D(ON)}$	—	4.1	—	ns	$V_{DD} = -10V, I_D = -1.6A, R_G = 6\Omega,$ $R_D = 6.1\Omega$ (Refer to test circuit)
Turn-On Rise Time	t_R	—	15.4	—	ns	
Turn-Off Delay Time	$t_{D(OFF)}$	—	12.0	—	ns	
Turn-Off Fall Time	t_F	—	19.2	—	ns	
SOURCE-DRAIN DIODE						
Diode Forward Voltage (Note 8)	V_{SD}	—	—	-0.95	V	$T_J = +25^\circ C, I_S = -1.6A,$ $V_{GS} = 0V$
Reverse recovery time (Note 10)	t_{RR}	—	22.5	—	ns	$T_J = +25^\circ C, I_F = -1.6A,$
Reverse recovery charge (Note 10)	Q_{RR}	—	10.4	—	nC	$di/dt = 100A/\mu s$

- Notes:
5. For a device surface mounted on 25mm x 25mm FR-4 PCB with high coverage of single sided 1oz copper, in still air conditions.
 6. For a device surface mounted on FR-4 PCB measured at $t \leq 5$ secs.
 7. Repetitive rating - pulse width limited by maximum junction temperature. Refer to Transient Thermal Impedance graph.
 8. Measured under pulsed conditions. Width= 300 μs ; duty cycle $\leq 2\%$.
 9. Switching characteristics are independent of operating junction temperatures.
 10. For design aid only, not subject to production testing.

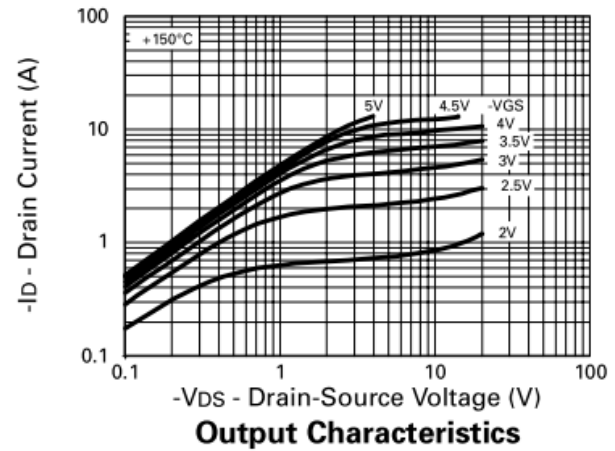
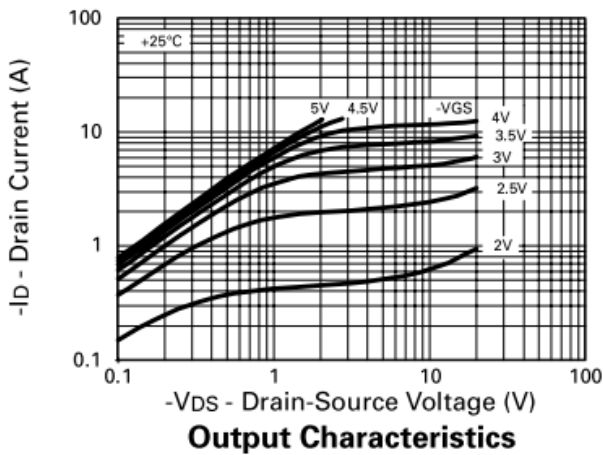
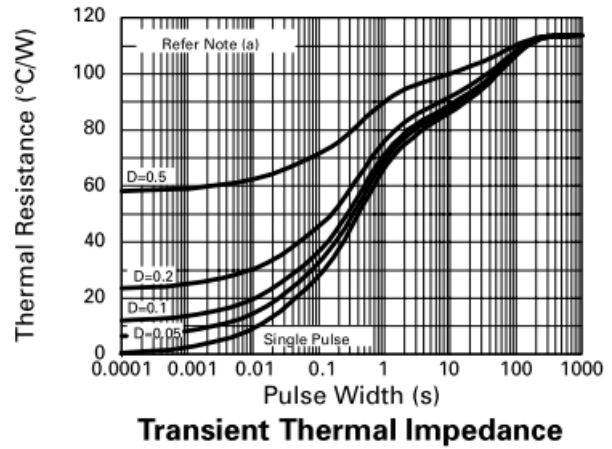
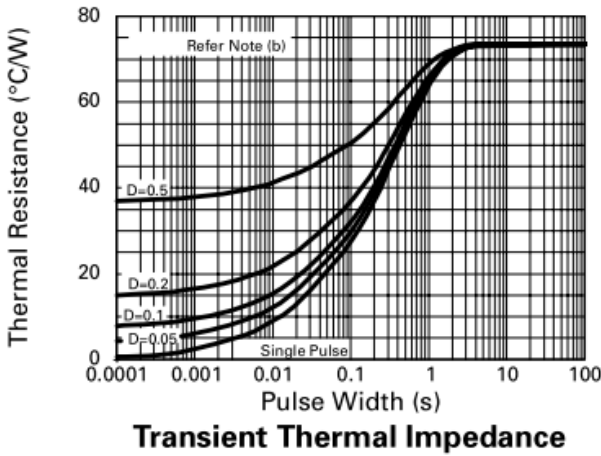
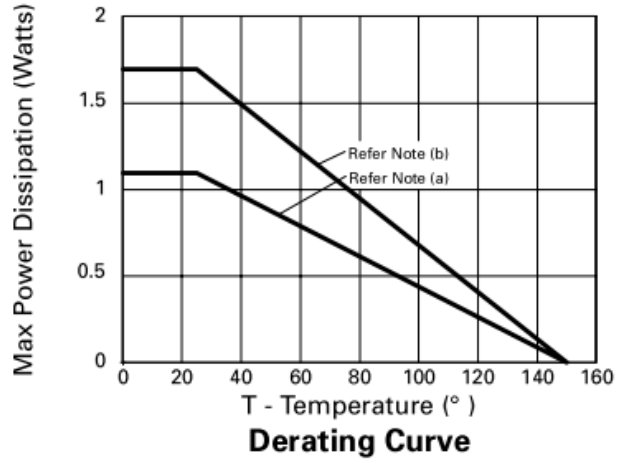
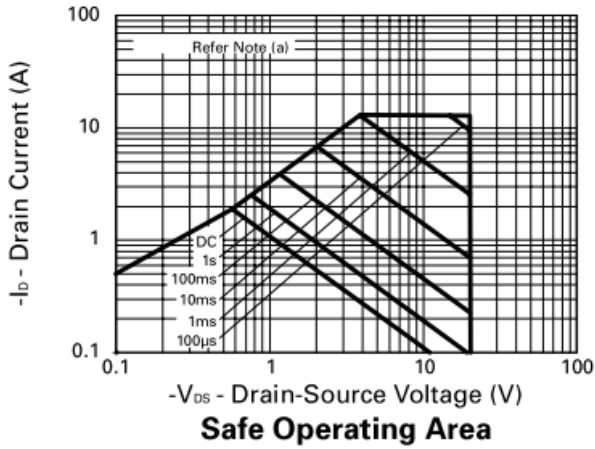

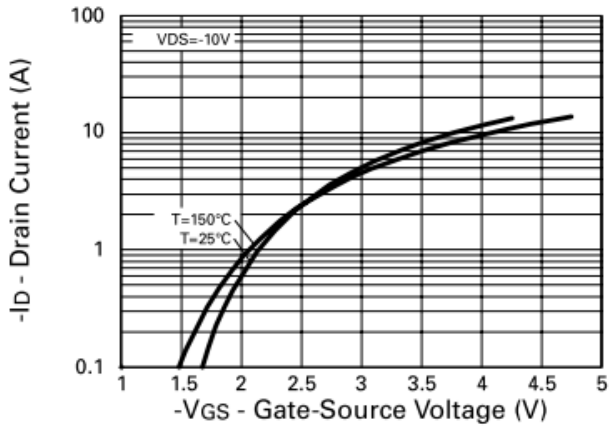

Typical Transfer Characteristics

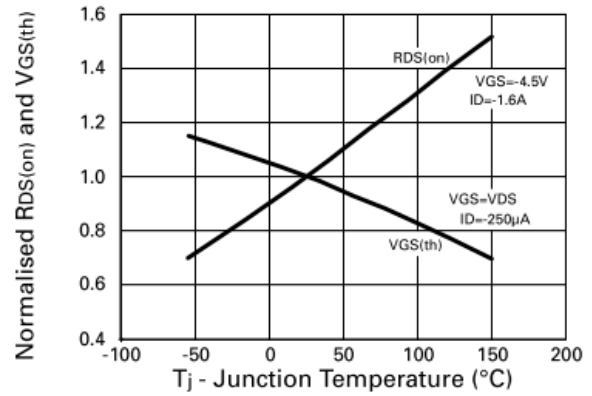

Normalised RDS(on) and VGS(th) v Temperature

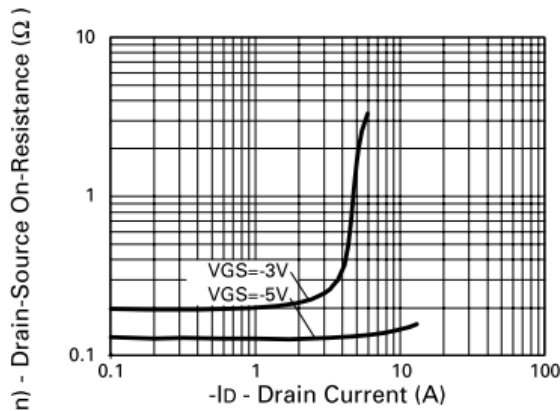

On-Resistance v Drain Current

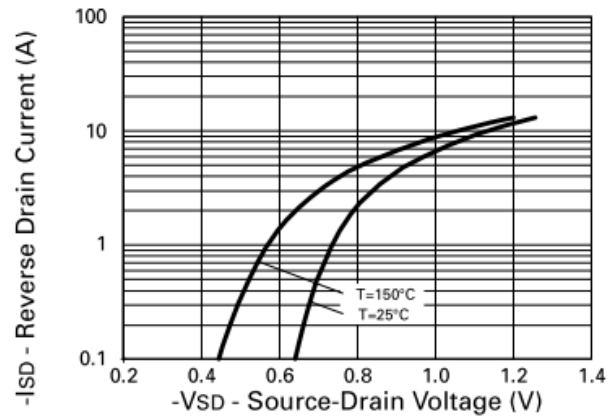

Source-Drain Diode Forward Voltage

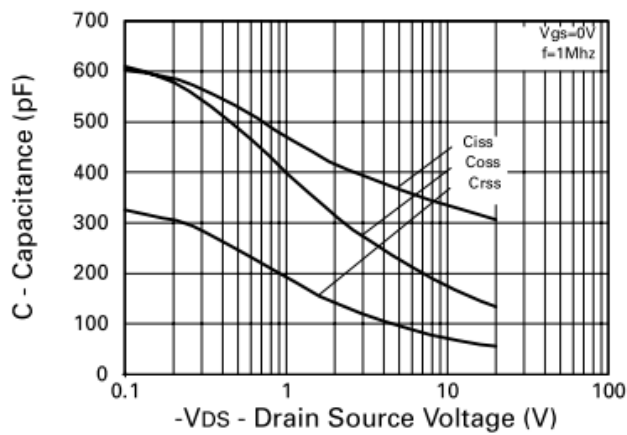

Capacitance v Drain-Source Voltage

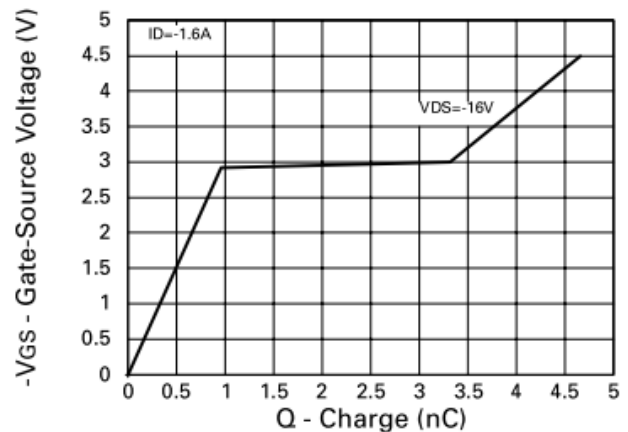

Gate-Source Voltage v Gate Charge

Test Circuits

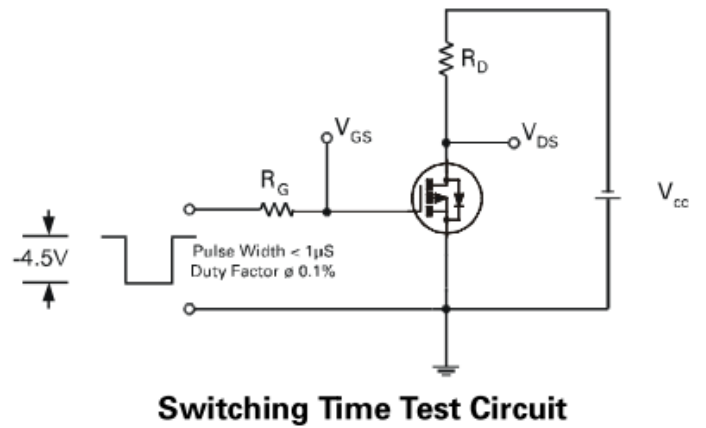
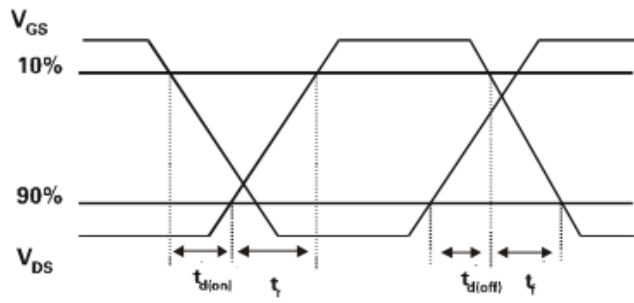
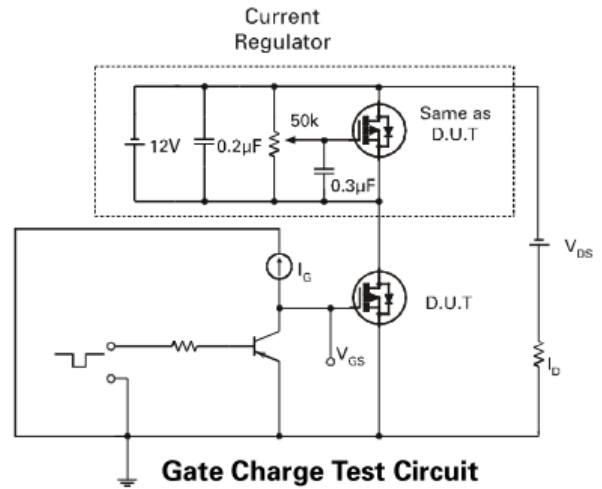
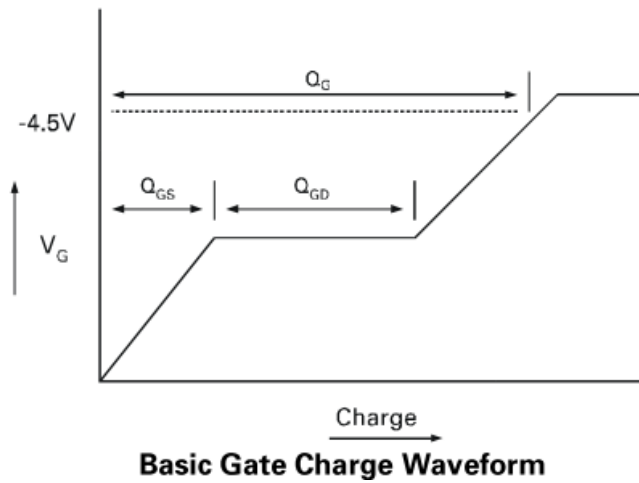

Package Outline Dimensions

Please see AP02002 at <http://www.diodes.com/datasheets/ap02002.pdf> for the latest version.

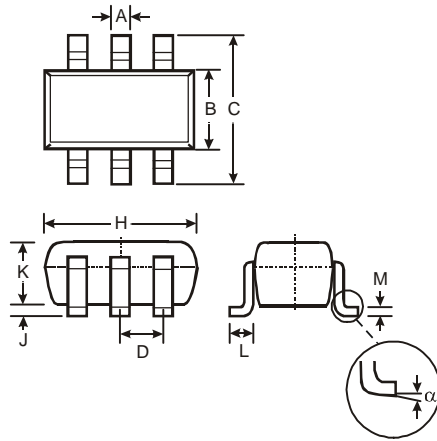

SOT26			
Dim	Min	Max	Typ
A	0.35	0.50	0.38
B	1.50	1.70	1.60
C	2.70	3.00	2.80
D	—	—	0.95
H	2.90	3.10	3.00
J	0.013	0.10	0.05
K	1.00	1.30	1.10
L	0.35	0.55	0.40
M	0.10	0.20	0.15
α	0°	8°	—
All Dimensions in mm			

Suggested Pad Layout

Please see AP02001 at <http://www.diodes.com/datasheets/ap02001.pdf> for the latest version.

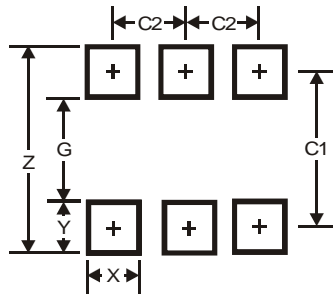

Dimensions	Value (in mm)
Z	3.20
G	1.60
X	0.55
Y	0.80
C1	2.40
C2	0.95

IMPORTANT NOTICE

DIODES INCORPORATED MAKES NO WARRANTY OF ANY KIND, EXPRESS OR IMPLIED, WITH REGARDS TO THIS DOCUMENT, INCLUDING, BUT NOT LIMITED TO, THE IMPLIED WARRANTIES OF MERCHANTABILITY AND FITNESS FOR A PARTICULAR PURPOSE (AND THEIR EQUIVALENTS UNDER THE LAWS OF ANY JURISDICTION).

Diodes Incorporated and its subsidiaries reserve the right to make modifications, enhancements, improvements, corrections or other changes without further notice to this document and any product described herein. Diodes Incorporated does not assume any liability arising out of the application or use of this document or any product described herein; neither does Diodes Incorporated convey any license under its patent or trademark rights, nor the rights of others. Any Customer or user of this document or products described herein in such applications shall assume all risks of such use and will agree to hold Diodes Incorporated and all the companies whose products are represented on Diodes Incorporated website, harmless against all damages.

Diodes Incorporated does not warrant or accept any liability whatsoever in respect of any products purchased through unauthorized sales channel. Should Customers purchase or use Diodes Incorporated products for any unintended or unauthorized application, Customers shall indemnify and hold Diodes Incorporated and its representatives harmless against all claims, damages, expenses, and attorney fees arising out of, directly or indirectly, any claim of personal injury or death associated with such unintended or unauthorized application.

Products described herein may be covered by one or more United States, international or foreign patents pending. Product names and markings noted herein may also be covered by one or more United States, international or foreign trademarks.

This document is written in English but may be translated into multiple languages for reference. Only the English version of this document is the final and determinative format released by Diodes Incorporated.

LIFE SUPPORT

Diodes Incorporated products are specifically not authorized for use as critical components in life support devices or systems without the express written approval of the Chief Executive Officer of Diodes Incorporated. As used herein:

A. Life support devices or systems are devices or systems which:

1. are intended to implant into the body, or
2. support or sustain life and whose failure to perform when properly used in accordance with instructions for use provided in the labeling can be reasonably expected to result in significant injury to the user.

B. A critical component is any component in a life support device or system whose failure to perform can be reasonably expected to cause the failure of the life support device or to affect its safety or effectiveness.

Customers represent that they have all necessary expertise in the safety and regulatory ramifications of their life support devices or systems, and acknowledge and agree that they are solely responsible for all legal, regulatory and safety-related requirements concerning their products and any use of Diodes Incorporated products in such safety-critical, life support devices or systems, notwithstanding any devices- or systems-related information or support that may be provided by Diodes Incorporated. Further, Customers must fully indemnify Diodes Incorporated and its representatives against any damages arising out of the use of Diodes Incorporated products in such safety-critical, life support devices or systems.

Copyright © 2015, Diodes Incorporated

www.diodes.com

单击下面可查看定价，库存，交付和生命周期等信息

[>>Diodes Incorporated\(达尔科技\)](#)