

Features

- Three Isolated Zeners in Ultra-Small Surface Mount Package
- Ideally Suited for Automated Assembly Processes
- **Totally Lead-Free & Fully RoHS Compliant (Notes 1 & 2)**
- **Halogen and Antimony Free. "Green" Device (Note 3)**
- **Qualified to AEC-Q101 Standards for High Reliability**

Mechanical Data

- Case: SOT363
- Case Material: Molded Plastic. UL Flammability Classification Rating 94V-0
- Moisture Sensitivity: Level 1 per J-STD-020D
- Terminals: Solderable per MIL-STD-202, Method 208 ⁽³⁾
- Lead Free Plating (Matte Tin Finish annealed over Alloy 42 leadframe).
- Orientation: See Diagram
- Weight: 0.006 grams (approximate)

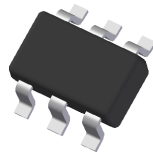

Top View

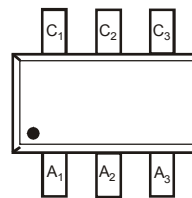

Package Pin Configuration

Ordering Information (Note 4)

Device	Packaging	Shipping
(Type Number)-7-F*	SOT363	3000/Tape & Reel

* Add "-7-F" to the appropriate type number in Electrical Characteristics Table, example: 6.2V Zener = MMBZ5234BTS-7-F.

- Notes:
1. No purposely added lead. Fully EU Directive 2002/95/EC (RoHS) & 2011/65/EU (RoHS 2) compliant.
 2. See http://www.diodes.com/quality/lead_free.html for more information about Diodes Incorporated's definitions of Halogen- and Antimony-free, "Green" and Lead-free.
 3. Halogen- and Antimony-free "Green" products are defined as those which contain <900ppm bromine, <900ppm chlorine (<1500ppm total Br + Cl) and <1000ppm antimony compounds.
 4. For packaging details, go to our website at <http://www.diodes.com/products/packages.html>.

Marking Information

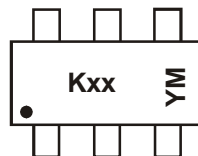

Kxx = Product Type Marking Code
(See Electrical Characteristic Table)
YM = Date Code Marking
Y = Year (ex: A = 2013)
M = Month (ex: 9 = September)

Date Code Key

Year	2005	2006	2007	2008	2009	2010	2111	2012	2013	2014	2015
Code	S	T	U	V	W	X	Y	Z	A	B	C

Month	Jan	Feb	Mar	Apr	May	Jun	Jul	Aug	Sep	Oct	Nov	Dec
Code	1	2	3	4	5	6	7	8	9	O	N	D

Maximum Ratings (@T_A = +25°C, unless otherwise specified.)

Characteristic	Symbol	Value	Unit
Forward Voltage (Note 5) @ I _F = 10mA	V _F	0.9	V

Note: 5. Short duration pulse test used to minimize self-heating effect.

Thermal Characteristics

Characteristic	Symbol	Value	Unit
Power Dissipation (Note 6)	P_D	200	mW
Thermal Resistance, Junction to Ambient Air (Note 6)	$R_{\theta JA}$	625	°C/W
Operating and Storage Temperature Range	T_J, T_{STG}	-65 to +150	°C

Electrical Characteristics (@ $T_A = +25^\circ\text{C}$, unless otherwise specified.)

Type Number	Marking Code	Zener Voltage Range (Note 7)				Maximum Zener Impedance (Note 8)		Maximum Reverse Leakage Current (Note 7)	
		$V_Z @ I_{ZT}$			I_{ZT}	$Z_{ZT} @ I_{ZT}$	$Z_{ZK} @ I_{ZK} = 0.25\text{mA}$	I_R	@ V_R
		Nom (V)	Min (V)	Max (V)	mA	Ω		μA	V
MMBZ5221BTS	KSB	2.4	2.28	2.52	20	30	1200	100	1.0
MMBZ5223BTS	KSC	2.7	2.57	2.84	20	30	1300	75	1.0
MMBZ5225BTS	KSD	3.0	2.85	3.15	20	30	1600	50	1.0
MMBZ5226BTS	KSE	3.3	3.14	3.47	20	28	1600	25	1.0
MMBZ5227BTS	KSF	3.6	3.42	3.78	20	24	1700	15	1.0
MMBZ5228BTS	KSG	3.9	3.71	4.10	20	23	1900	10	1.0
MMBZ5229BTS	KSH	4.3	4.09	4.52	20	22	2000	5.0	1.0
MMBZ5230BTS	KS1	4.7	4.47	4.94	20	19	1900	5.0	2.0
MMBZ5231BTS	KS2	5.1	4.85	5.36	20	17	1600	5.0	2.0
MMBZ5232BTS	KS3	5.6	5.32	5.88	20	11	1600	5.0	3.0
MMBZ5233BTS	KRF	6.0	5.70	6.30	20	7	1600	5.0	3.5
MMBZ5234BTS	KS4	6.2	5.89	6.51	20	7	1000	5.0	4.0
MMBZ5235BTS	KS5	6.8	6.46	7.14	20	5	750	3.0	5.0
MMBZ5236BTS	KS6	7.5	7.13	7.88	20	6	500	3.0	6.0
MMBZ5237BTS	KS7	8.2	7.79	8.61	20	8	500	3.0	6.5
MMBZ5238BTS	KRG	8.7	8.27	9.14	20	8	600	3.0	6.5
MMBZ5239BTS	KS8	9.1	8.65	9.56	20	10	600	3.0	7.0
MMBZ5240BTS	KS9	10	9.50	10.50	20	17	600	3.0	8.0
MMBZ5241BTS	KR1	11	10.45	11.55	20	22	600	2.0	8.4
MMBZ5242BTS	KR2	12	11.40	12.60	20	30	600	1.0	9.1
MMBZ5243BTS	KR3	13	12.35	13.65	9.5	13	600	0.5	9.9
MMBZ5245BTS	KR4	15	14.25	15.75	8.5	16	600	0.1	11
MMBZ5246BTS	KR5	16	15.20	16.80	7.8	17	600	0.1	12
MMBZ5248BTS	KR6	18	17.10	18.90	7.0	21	600	0.1	14
MMBZ5250BTS	KR7	20	19.00	21.00	6.2	25	600	0.1	15
MMBZ5251BTS	KR8	22	20.90	23.10	5.6	29	600	0.1	17
MMBZ5252BTS	KR9	24	22.80	25.20	5.2	33	600	0.1	18
MMBZ5254BTS	KRA	27	25.65	28.35	5.0	41	600	0.1	21
MMBZ5255BTS	KRH	28	26.60	29.40	4.5	44	600	0.1	21
MMBZ5256BTS	KRB	30	28.50	31.50	4.2	49	600	0.1	23
MMBZ5257BTS	KRC	33	31.35	34.65	3.8	58	700	0.1	25
MMBZ5258BTS	KRD	36	34.20	37.80	3.4	70	700	0.1	27
MMBZ5259BTS	KRE	39	37.05	40.95	3.2	80	800	0.1	30

Notes: 6. Mounted on FR4 PC Board with recommended pad layout which can be found on our website at <http://www.diodes.com/datasheets/ap02001.pdf>.
7. Short duration pulse test used to minimize self-heating effect.
8. $f = 1\text{KHz}$.

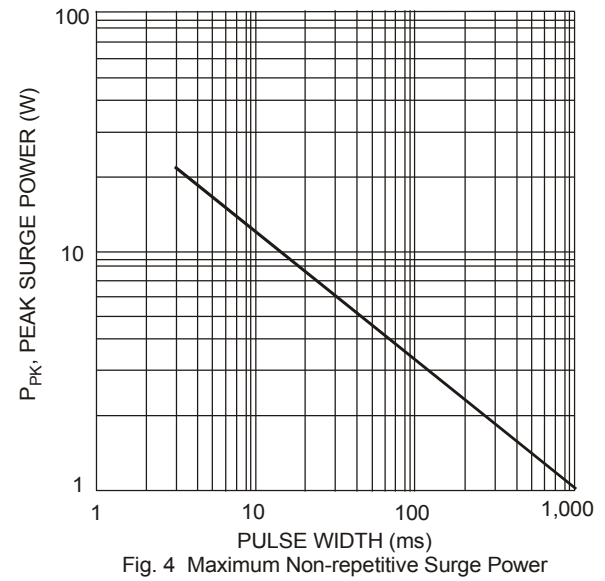
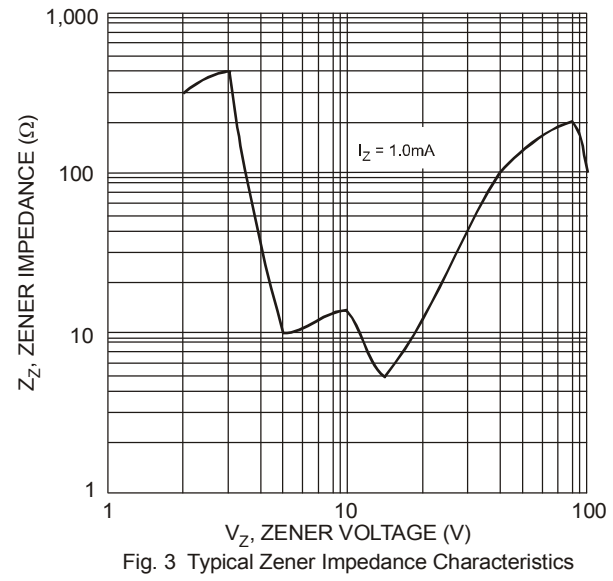
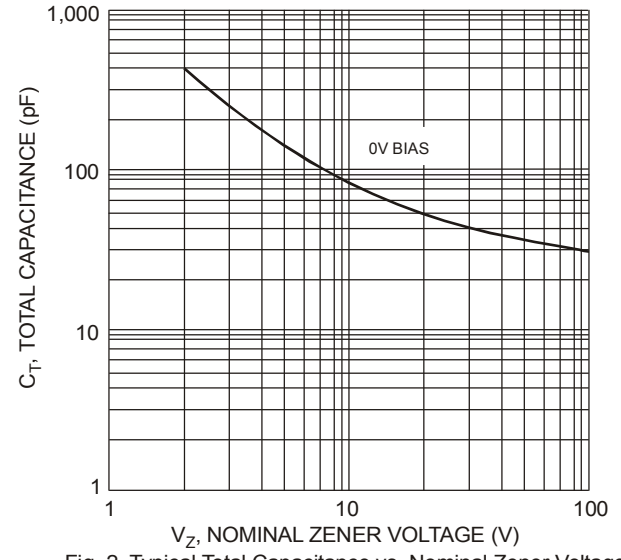
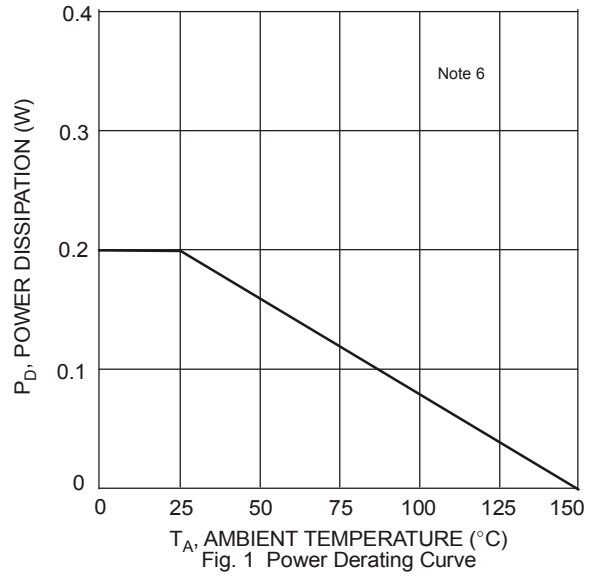

Package Outline Dimensions

Please see AP02002 at <http://www.diodes.com/datasheets/ap02002.pdf> for latest version.

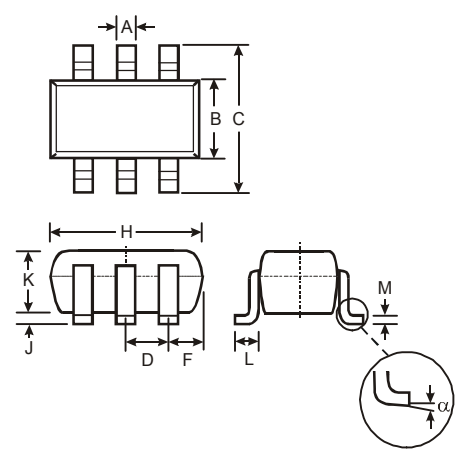

SOT363			
Dim	Min	Max	Typ
A	0.10	0.30	0.25
B	1.15	1.35	1.30
C	2.00	2.20	2.10
D	0.65 Typ		
F	0.40	0.45	0.425
H	1.80	2.20	2.15
J	0	0.10	0.05
K	0.90	1.00	1.00
L	0.25	0.40	0.30
M	0.10	0.22	0.11
α	0°	8°	-
All Dimensions in mm			

Suggested Pad Layout

Please see AP02001 at <http://www.diodes.com/datasheets/ap02001.pdf> for latest version.

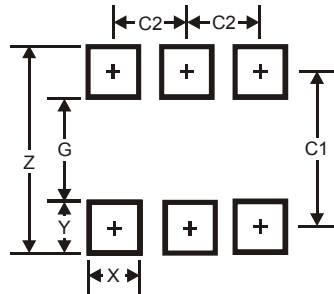

Dimensions	Value (in mm)
Z	2.5
G	1.3
X	0.42
Y	0.6
C1	1.9
C2	0.65

IMPORTANT NOTICE

DIODES INCORPORATED MAKES NO WARRANTY OF ANY KIND, EXPRESS OR IMPLIED, WITH REGARDS TO THIS DOCUMENT, INCLUDING, BUT NOT LIMITED TO, THE IMPLIED WARRANTIES OF MERCHANTABILITY AND FITNESS FOR A PARTICULAR PURPOSE (AND THEIR EQUIVALENTS UNDER THE LAWS OF ANY JURISDICTION).

Diodes Incorporated and its subsidiaries reserve the right to make modifications, enhancements, improvements, corrections or other changes without further notice to this document and any product described herein. Diodes Incorporated does not assume any liability arising out of the application or use of this document or any product described herein; neither does Diodes Incorporated convey any license under its patent or trademark rights, nor the rights of others. Any Customer or user of this document or products described herein in such applications shall assume all risks of such use and will agree to hold Diodes Incorporated and all the companies whose products are represented on Diodes Incorporated website, harmless against all damages.

Diodes Incorporated does not warrant or accept any liability whatsoever in respect of any products purchased through unauthorized sales channel. Should Customers purchase or use Diodes Incorporated products for any unintended or unauthorized application, Customers shall indemnify and hold Diodes Incorporated and its representatives harmless against all claims, damages, expenses, and attorney fees arising out of, directly or indirectly, any claim of personal injury or death associated with such unintended or unauthorized application.

Products described herein may be covered by one or more United States, international or foreign patents pending. Product names and markings noted herein may also be covered by one or more United States, international or foreign trademarks.

This document is written in English but may be translated into multiple languages for reference. Only the English version of this document is the final and determinative format released by Diodes Incorporated.

LIFE SUPPORT

Diodes Incorporated products are specifically not authorized for use as critical components in life support devices or systems without the express written approval of the Chief Executive Officer of Diodes Incorporated. As used herein:

A. Life support devices or systems are devices or systems which:

1. are intended to implant into the body, or
2. support or sustain life and whose failure to perform when properly used in accordance with instructions for use provided in the labeling can be reasonably expected to result in significant injury to the user.

B. A critical component is any component in a life support device or system whose failure to perform can be reasonably expected to cause the failure of the life support device or to affect its safety or effectiveness.

Customers represent that they have all necessary expertise in the safety and regulatory ramifications of their life support devices or systems, and acknowledge and agree that they are solely responsible for all legal, regulatory and safety-related requirements concerning their products and any use of Diodes Incorporated products in such safety-critical, life support devices or systems, notwithstanding any devices- or systems-related information or support that may be provided by Diodes Incorporated. Further, Customers must fully indemnify Diodes Incorporated and its representatives against any damages arising out of the use of Diodes Incorporated products in such safety-critical, life support devices or systems.

Copyright © 2013, Diodes Incorporated

www.diodes.com

单击下面可查看定价，库存，交付和生命周期等信息

[>>Diodes Incorporated\(达达科技\(美台\)\)](#)