

Description

The AH1897S is a high sensitivity micropower Omnipolar Hall effect switch IC with an internal pull up and pull down capability. Designed for portable and battery powered equipment such as cellular phones and portable PCs, the average supply current is only 4.3 μ A at 1.85V. To support portable equipment, the AH1897S can operate over the supply range of 1.6V to 3.6V and uses a hibernating clocking system to minimize the power consumption. To minimize PCB space, the AH1897S is available in a small low profile X1-DFN1216-4 (Type B) package.

The output is activated with either a North or South pole of sufficient magnetic field strength. When the magnetic flux density (B) is perpendicular to the package is larger than operate point (Bop), the output will be turned on (pulled low). The output is turned off when B becomes lower than the release point (Brp). The output will remain off when there is no magnetic field.

Features

- Omnipolar Operation (North or South Pole)
- Supply Voltage of 1.6V to 3.6V
- Micropower Operation
- Chopper Stabilized Design Provides:
 - Superior Temperature Stability
 - Minimal Switch Point Drift
 - Enhanced Immunity to Physical Stress
- No External Pull-Up Resistors Required
- Good RF Noise Immunity
- -40°C to +85°C Operating Temperature
- Small Low Profile X1-DFN1216-4 (Type B) Package
- Moisture Sensitivity: Level 1 per J-STD-020
- Terminals: Finish NiPdAu over Copper Leadframe, Solderable per MIL-STD-202, Method 208 (E4)
- Weight: 0.002 grams (Approximate)
- **Totally Lead-Free & Fully RoHS Compliant (Notes 1 & 2)**
- **Halogen and Antimony Free. "Green" Device (Note 3)**
- **For automotive applications requiring specific change control (i.e. parts qualified to AEC-Q100/101/200, PPAP capable, and manufactured in IATF 16949 certified facilities), please [contact us](#) or your local Diodes representative.**

<https://www.diodes.com/quality/product-definitions/>

- Notes:
1. No purposely added lead. Fully EU Directive 2002/95/EC (RoHS), 2011/65/EU (RoHS 2) & 2015/863/EU (RoHS 3) compliant.
 2. See <https://www.diodes.com/quality/lead-free/> for more information about Diodes Incorporated's definitions of Halogen- and Antimony-free, "Green" and Lead-free.
 3. Halogen- and Antimony-free "Green" products are defined as those which contain <900ppm bromine, <900ppm chlorine (<1500ppm total Br + Cl) and <1000ppm antimony compounds.

Pin Assignments

(Top View)

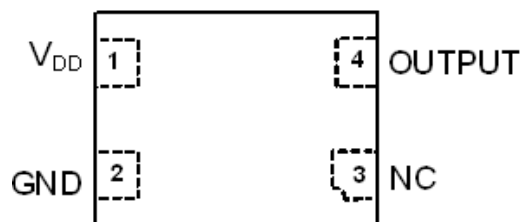

X1-DFN1216-4 (Type B)

Applications

- Cover or Display Switch in Portable PCs
- Open and Close Detect for Cellular Phones
- Holster or Cover Detect for Cellular Phones and Tablet PCs
- Digital Still, Video Cameras and Handheld Gaming Consoles
- Contact-Less Switches

Typical Applications Circuit

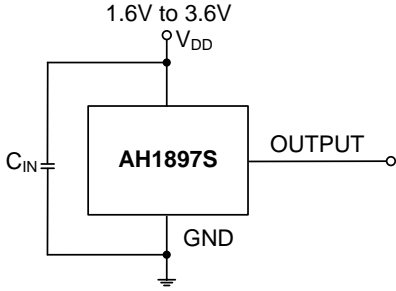

Note: 4. C_{IN} is for power stabilization and to strengthen the noise immunity, the recommended capacitance is 100nF typical.

Pin Descriptions

Package: X1-DFN1216-4 (Type B) without Center Exposed Pad

Pin Number	Pin Name	Function
1	V _{DD}	Power Supply Input
2	GND	Ground Pin
3	NC	No Connection (Note 5)
4	OUTPUT	Output Pin

Note: 5. NC is "No Connection" pin and is not connected internally. This pin can be left open or tied to ground.

Functional Block Diagram

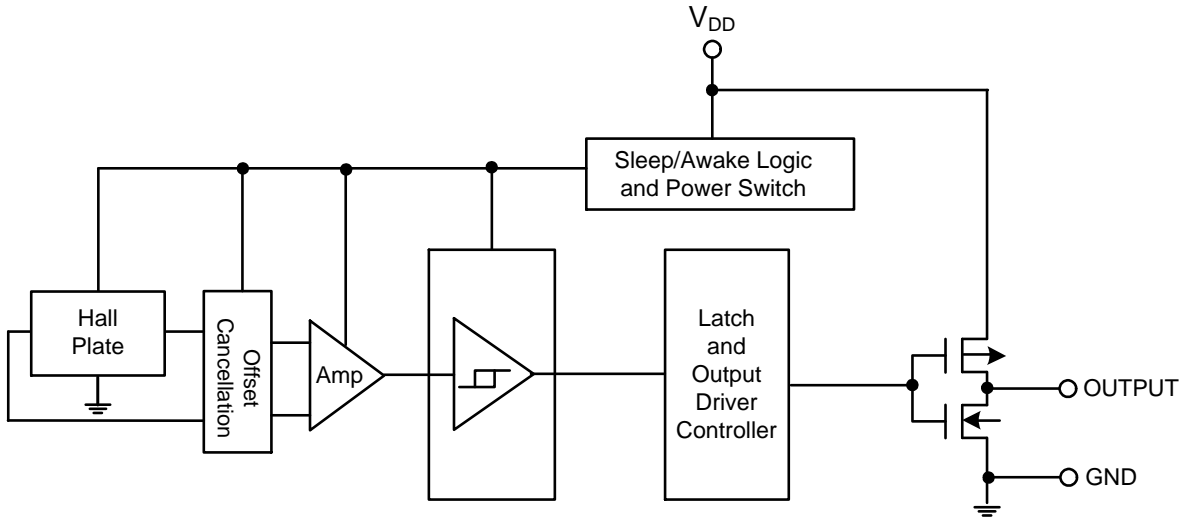

Absolute Maximum Ratings (Note 6) (@T_A = +25°C, unless otherwise specified.)

Symbol	Parameter	Rating	Unit
V _{DD}	Supply Voltage (Note 7)	6	V
V _{DD_REV}	Reverse Supply Voltage	-0.3	V
I _{OUTPUT}	Output Current (Source and Sink)	3	mA
B	Magnetic Flux Density	Unlimited	
P _D	Package Power Dissipation	230	mW
T _S	Storage Temperature Range	-65 to +150	°C
T _J	Maximum Junction Temperature	150	°C
ESD HBM	Human Body Model (HBM) ESD Capability	8	kV

- Notes:
- Stresses greater than the 'Absolute Maximum Ratings' specified above can cause permanent damage to the device. These are stress ratings only; functional operation of the device at these or any other conditions exceeding those indicated in this specification is not implied. Device reliability can be affected by exposure to absolute maximum rating conditions for extended periods of time.
 - The absolute maximum V_{DD} of 6V is a transient stress rating and is not meant as a functional operating condition. It is not recommended to operate the device at the absolute maximum rated conditions for any period of time.

Recommended Operating Conditions (@T_A = +25°C, unless otherwise specified.)

Symbol	Parameter	Conditions	Rating	Unit
V _{DD}	Supply Voltage	Operating	1.6V to 3.6V	V
T _A	Operating Temperature Range	Operating	-40 to +85	°C

Electrical Characteristics (@T_A = +25°C, V_{DD} = 3.0V, unless otherwise specified.)

Symbol	Parameter	Conditions	Min	Typ	Max	Unit
V _{OL}	Output Low Voltage (ON)	I _{OUT} = 1mA	—	0.1	0.2	V
V _{OH}	Output High Voltage (OFF)	I _{OUT} = -1mA	V _{DD} - 0.2	V _{DD} - 0.1	—	V
I _{OFF}	Output Leakage Current	V _{OUT} = 3.6V, Output off	—	< 0.1	1	µA
I _{DD(awake)}	Supply Current	During 'Awake' Period	—	2.1	—	mA
I _{DD(sleep)}		During 'Sleep' Period	—	2.5	—	µA
I _{DD(avg)}	Average Supply Current	T _A = +25°C, V _{DD} = 1.8V	—	4.3	8	µA
		T _A = +25°C, V _{DD} = 3.6V	—	7.2	13	µA
t _{AWAKE}	Awake Time	(Note 8)	—	50	100	µs
t _{PERIOD}	Period	(Note 8)	—	50	100	ms
D.C.	Duty Cycle	—	—	0.1	—	%

- Note:
- When power is initially turned on, the operating V_{DD} (1.6V to 3.6V) must be applied to guaranteed the output sampling. The output state is valid after the second operating cycle (typical 100ms).

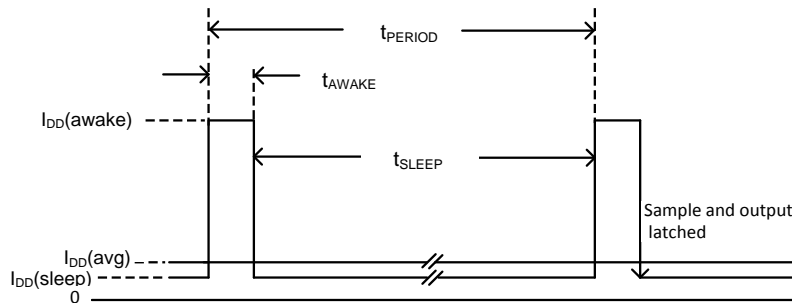

Magnetic Characteristics ($T_A = +25^\circ\text{C}$, $V_{DD} = 3.0\text{V}$, unless otherwise specified)

(1mT=10 Gauss)

Symbol	Characteristics	Min	Typ	Max	Unit
B_{ops} (South Pole to Part Marking Side)	Operation Point	14	30	40	Gauss
B_{opn} (North Pole to Part Marking Side)		-40	-30	-14	
B_{rps} (South Pole to Part Marking Side)	Release Point	10	20	35	
B_{rpn} (North Pole to Part Marking Side)		-35	-20	-10	
B_{HY} ($ B_{opx} - B_{rpx} $)	Hysteresis	—	10	—	

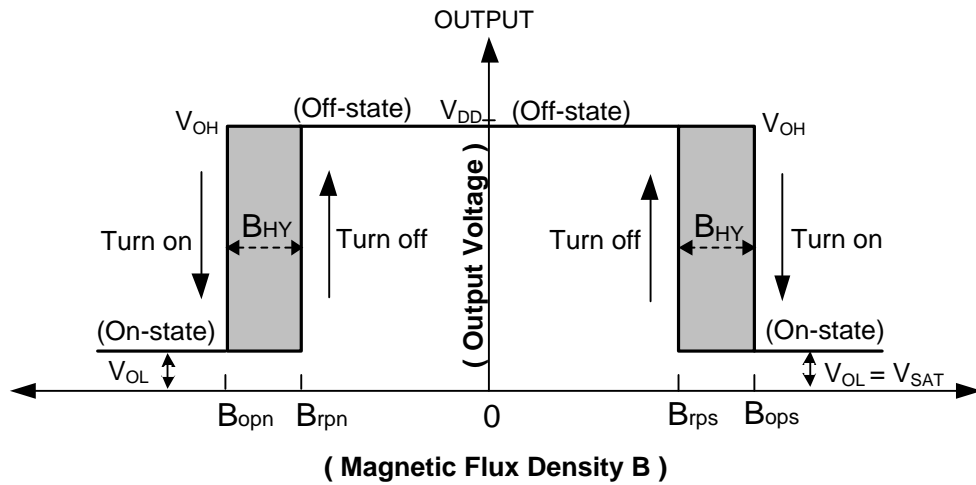

Typical Operating Characteristics

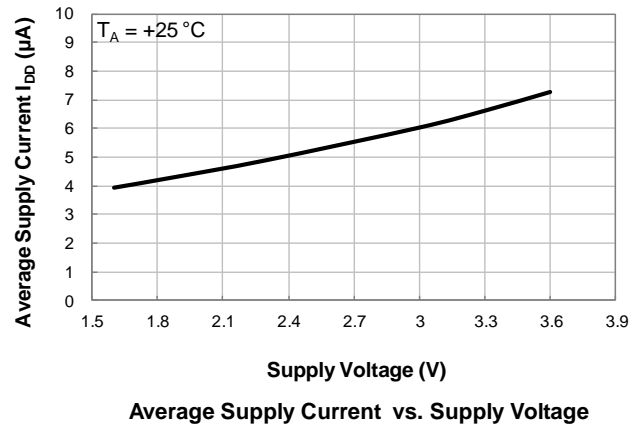
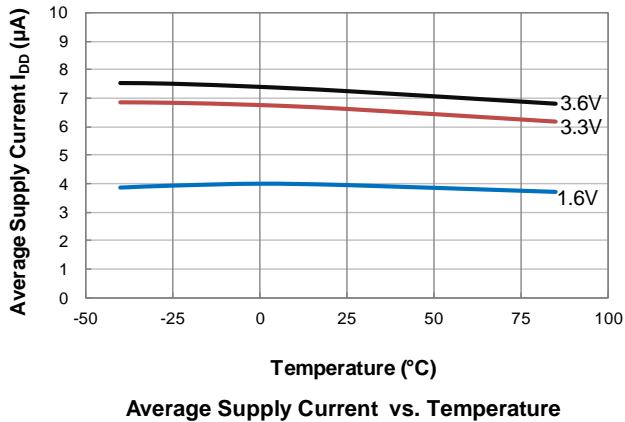
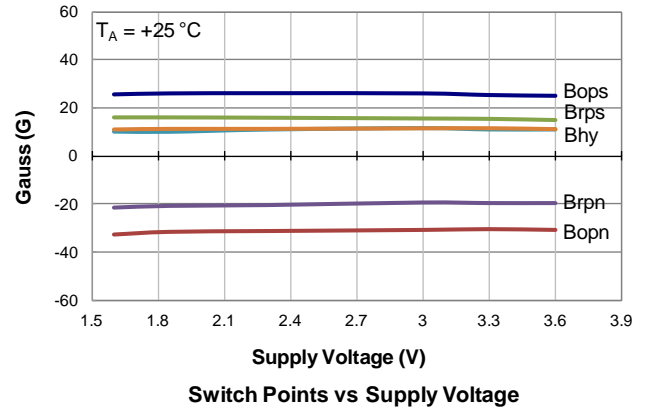
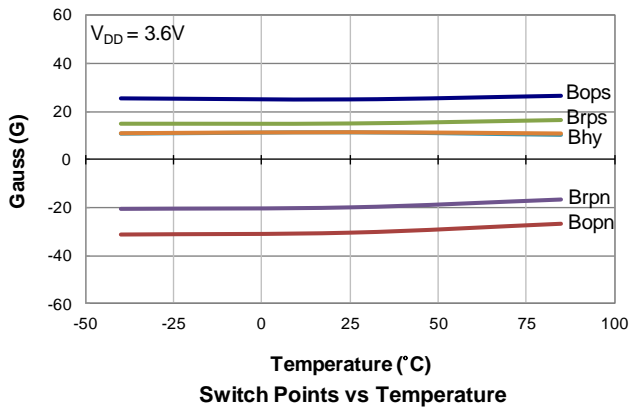
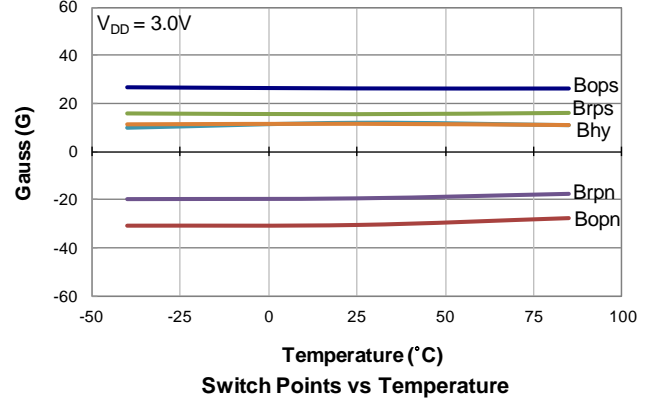
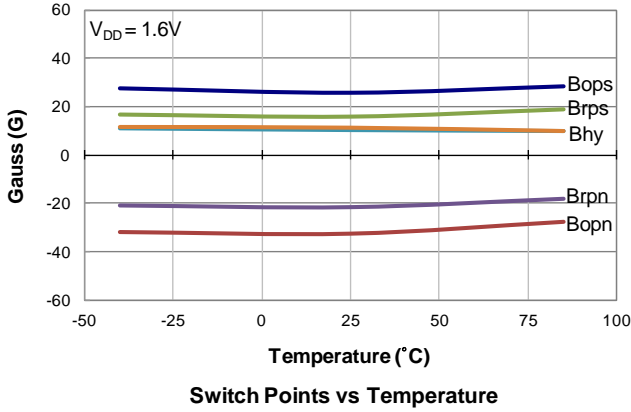

Ordering Information

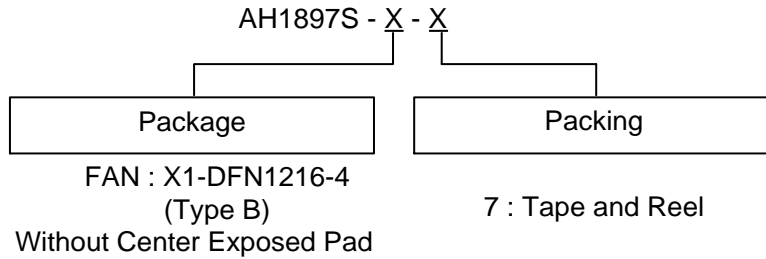

Part Number	Package Code	Packaging	7" Tape and Reel	
			Quantity	Part Number Suffix
AH1897S-FAN-7	FAN	X1-DFN1216-4 (Type B) (Without Exposed Pad)	3000/Tape & Reel	-7

Marking Information

(1) Package Type: X1-DFN1216-4 (Type B)

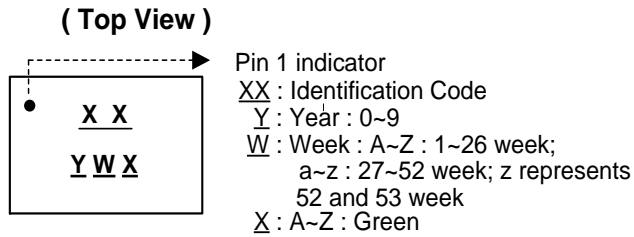

Part Number	Package	Identification Code
AH1897S-FAN-7	X1-DFN1216-4 (Type B) (Without Exposed Pad)	S7

Package Outline Dimensions (All dimensions in mm.)

Please see <http://www.diodes.com/package-outlines.html> for the latest version.

(1) Package Type: X1-DFN1216-4 (Type B) (Without Center Exposed Pad)

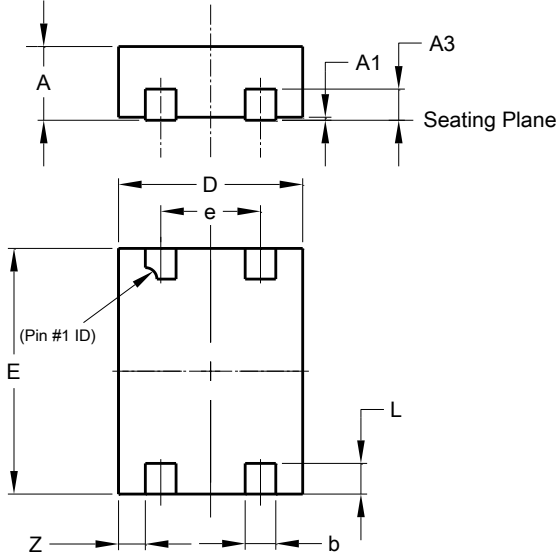

X1-DFN1216-4 (Type B)			
Dim	Min	Max	Typ
A	0.46	0.50	0.48
A1	0.00	0.05	0.02
A3	-	-	0.203
b	0.15	0.25	0.20
D	1.16	1.24	1.20
E	1.57	1.63	1.60
e	-	-	0.65
L	0.15	0.25	0.20
Z	-	-	0.175
All Dimensions in mm			

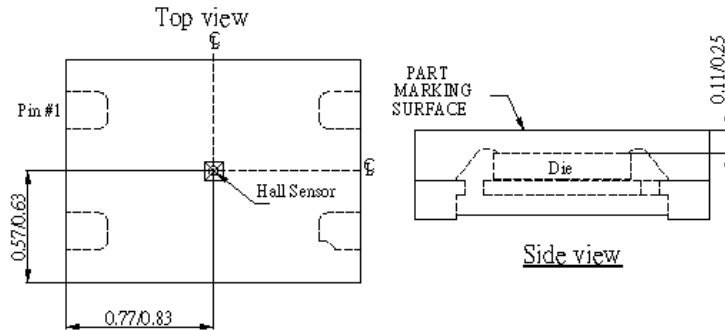

Suggested Pad Layout

Please see <http://www.diodes.com/package-outlines.html> for the latest version.

(1) Package Type: X1-DFN1216-4 (Type B) (Without Center Exposed Pad)

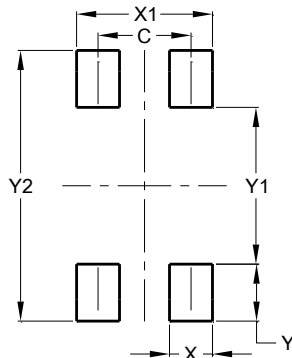

Dimensions	Value (in mm)
C	0.650
X	0.300
X1	0.950
Y	0.400
Y1	1.100
Y2	1.900

IMPORTANT NOTICE

DIODES INCORPORATED MAKES NO WARRANTY OF ANY KIND, EXPRESS OR IMPLIED, WITH REGARDS TO THIS DOCUMENT, INCLUDING, BUT NOT LIMITED TO, THE IMPLIED WARRANTIES OF MERCHANTABILITY AND FITNESS FOR A PARTICULAR PURPOSE (AND THEIR EQUIVALENTS UNDER THE LAWS OF ANY JURISDICTION).

Diodes Incorporated and its subsidiaries reserve the right to make modifications, enhancements, improvements, corrections or other changes without further notice to this document and any product described herein. Diodes Incorporated does not assume any liability arising out of the application or use of this document or any product described herein; neither does Diodes Incorporated convey any license under its patent or trademark rights, nor the rights of others. Any Customer or user of this document or products described herein in such applications shall assume all risks of such use and will agree to hold Diodes Incorporated and all the companies whose products are represented on Diodes Incorporated website, harmless against all damages.

Diodes Incorporated does not warrant or accept any liability whatsoever in respect of any products purchased through unauthorized sales channel. Should Customers purchase or use Diodes Incorporated products for any unintended or unauthorized application, Customers shall indemnify and hold Diodes Incorporated and its representatives harmless against all claims, damages, expenses, and attorney fees arising out of, directly or indirectly, any claim of personal injury or death associated with such unintended or unauthorized application.

Products described herein may be covered by one or more United States, international or foreign patents pending. Product names and markings noted herein may also be covered by one or more United States, international or foreign trademarks.

This document is written in English but may be translated into multiple languages for reference. Only the English version of this document is the final and determinative format released by Diodes Incorporated.

LIFE SUPPORT

Diodes Incorporated products are specifically not authorized for use as critical components in life support devices or systems without the express written approval of the Chief Executive Officer of Diodes Incorporated. As used herein:

A. Life support devices or systems are devices or systems which:

1. are intended to implant into the body, or
2. support or sustain life and whose failure to perform when properly used in accordance with instructions for use provided in the labeling can be reasonably expected to result in significant injury to the user.

B. A critical component is any component in a life support device or system whose failure to perform can be reasonably expected to cause the failure of the life support device or to affect its safety or effectiveness.

Customers represent that they have all necessary expertise in the safety and regulatory ramifications of their life support devices or systems, and acknowledge and agree that they are solely responsible for all legal, regulatory and safety-related requirements concerning their products and any use of Diodes Incorporated products in such safety-critical, life support devices or systems, notwithstanding any devices- or systems-related information or support that may be provided by Diodes Incorporated. Further, Customers must fully indemnify Diodes Incorporated and its representatives against any damages arising out of the use of Diodes Incorporated products in such safety-critical, life support devices or systems.

Copyright © 2020, Diodes Incorporated

www.diodes.com

单击下面可查看定价，库存，交付和生命周期等信息

[>>Diodes Incorporated\(达达科技\(美台\)\)](#)