

Product Summary

V _{RRM} (V)	I _O (A)	V _{F MAX} (V)	I _{R MAX} (μA)
100	0.5	0.73	25

Description and Applications

The SBR05M100BLP has four diodes in full bridge configuration packaged in the low profile DFN package. Offering low forward voltage drop and excellent high temperature stability, this device is ideal for use as Bridge Diodes where small footprint and low profile is desired.

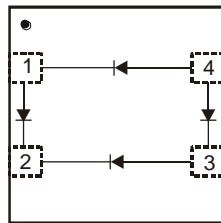

Features

- Low Forward Voltage Drop (V_F) and Low Reverse Leakage (I_R)
- Excellent High Temperature Stability
- Patented Super Barrier Rectifier SBR[®] Technology
- Low Profile Package with Excellent Thermal Dissipation
- **Totally Lead-Free & Fully RoHS Compliant (Notes 1 & 2)**
- **Halogen and Antimony Free. "Green" Device (Note 3)**

Mechanical Data

- Case: U-DFN3030-4
- Case Material: Molded Plastic "Green" Molding Compound, UL Flammability Classification Rating 94V-0
- Moisture Sensitivity: Level 1 per J-STD-020
- Terminals: Finish – NiPdAu Over Copper Lead Frame, Solderable per MIL-STD-202, Method 208 (e4)
- Polarity: See Diagram
- Weight: 0.02 grams (Approximate)

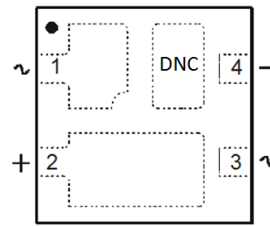

Top View
Pin Configuration
Do Not Connect the DNC Pad

Ordering Information (Note 4)

Part Number	Case	Packaging
SBR05M100BLP-7	U-DFN3030-4	3000/Tape & Reel

- Notes:
1. No purposely added lead. Fully EU Directive 2002/95/EC (RoHS) & 2011/65/EU (RoHS 2) compliant.
 2. See http://www.diodes.com/quality/lead_free.html for more information about Diodes Incorporated's definitions of Halogen- and Antimony-free, "Green" and Lead-free.
 3. Halogen- and Antimony-free "Green" products are defined as those which contain <900ppm bromine, <900ppm chlorine (<1500ppm total Br + Cl) and <1000ppm antimony compounds.
 4. For packaging details, go to our website at <http://www.diodes.com/products/packages.html>.

Marking Information

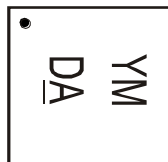

DA = Product Type Marking Code
YM = Date Code Marking
Y = Year (ex: D = 2016)
M = Month (ex: 9 = September)

U-DFN3030-4

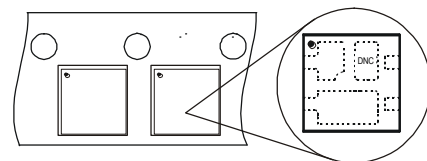

Date Code Key

Year Code	2015	2016	2017	2018	2019	2020	2021
Code	C	D	E	F	G	H	I

Month Code	Jan	Feb	Mar	Apr	May	Jun	Jul	Aug	Sep	Oct	Nov	Dec
Code	1	2	3	4	5	6	7	8	9	O	N	D

Maximum Ratings (@T_A = +25°C, unless otherwise specified.)

Single phase, half wave, 60Hz, resistive or inductive load.
For capacitive load, derate current by 20%.

Characteristic	Symbol	Value	Unit
Peak Repetitive Reverse Voltage	V _{RRM}	100	V
Working Peak Reverse Voltage	V _{RWM}		
DC Blocking Voltage	V _{RM}		
RMS Reverse Voltage	V _{R(RMS)}	70	V
Average Rectified Output Current	I _O	500	mA
Non-Repetitive Peak Forward Surge Current 8.3ms Single Half Sine-Wave Superimposed on Rated Load (Per Diode)	I _{FSM}	8	A

Thermal Characteristics

Characteristic	Symbol	Typ	Max	Unit
Power Dissipation (Note 5)	P _D	-	0.56	W
Thermal Resistance Junction to Ambient Air (Note 5)	R _{θJA}	-	222	°C/W
Thermal Resistance Junction to Ambient Air (Note 6)	R _{θJA}	-	149	°C/W
Operating and Storage Temperature Range	T _J , T _{STG}	-55 to +150		°C

Electrical Characteristics (@T_A = +25°C, unless otherwise specified.)

Characteristic	Symbol	Min	Typ	Max	Unit	Test Condition
Reverse Breakdown Voltage	V _{(BR)R}	100	-	-	V	I _R = 250μA
Forward Voltage (Per Diode)	V _F	-	0.54	0.60	V	I _F = 0.25A, T _J = +25°C
			0.67	0.73		I _F = 0.5A, T _J = +25°C
			0.56	0.63		I _F = 0.5A, T _J = +125°C
Reverse Current (Note 7) (Per Diode)	I _R	-	0.3	25	μA	V _R = 100V, T _J = +25°C
			32	250		V _R = 100V, T _J = +125°C

- Notes: 5. FR-4 PCB, 2 oz. copper, minimum recommended pad layout per <http://www.diodes.com/package-outlines.html>.
6. Polyimide PCB, 2 oz. copper; minimum recommended pad layout per <http://www.diodes.com/package-outlines.html>.
7. Short duration pulse test used to minimize self-heating effect.

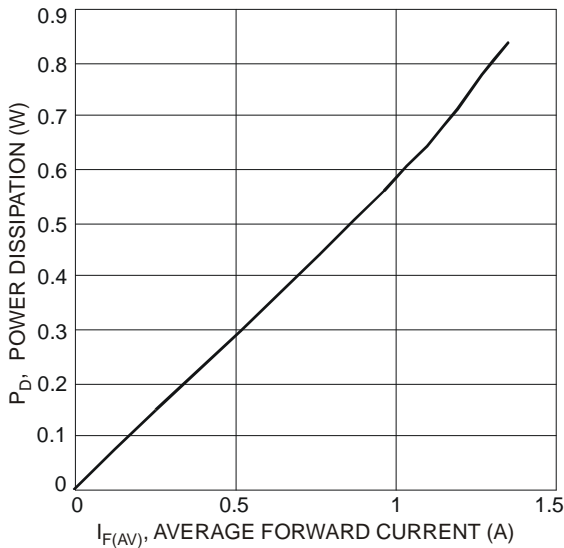

Fig. 1 Forward Power Dissipation

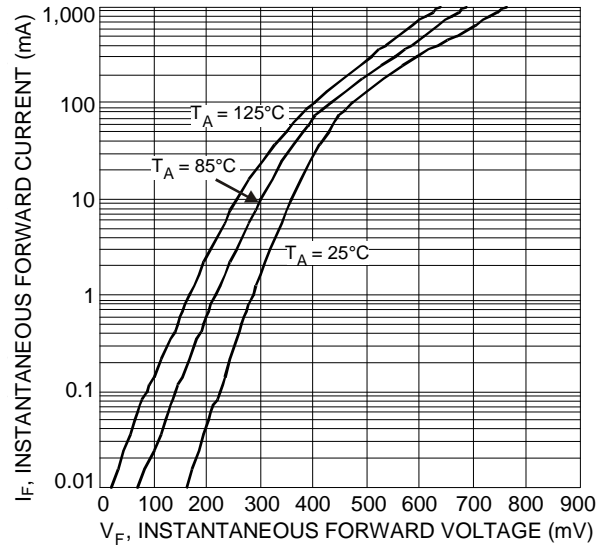
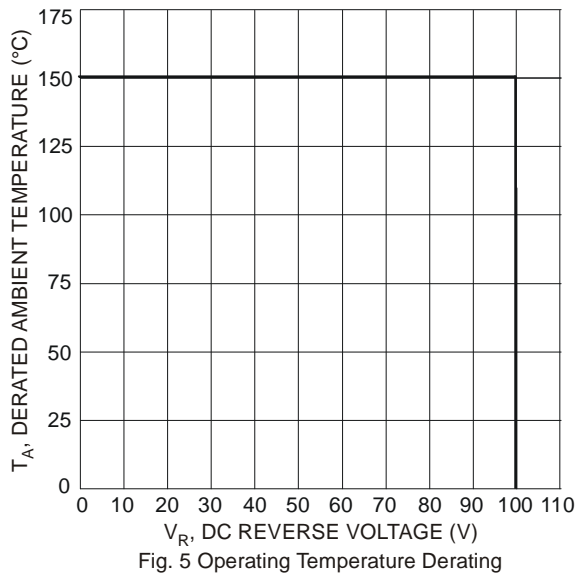
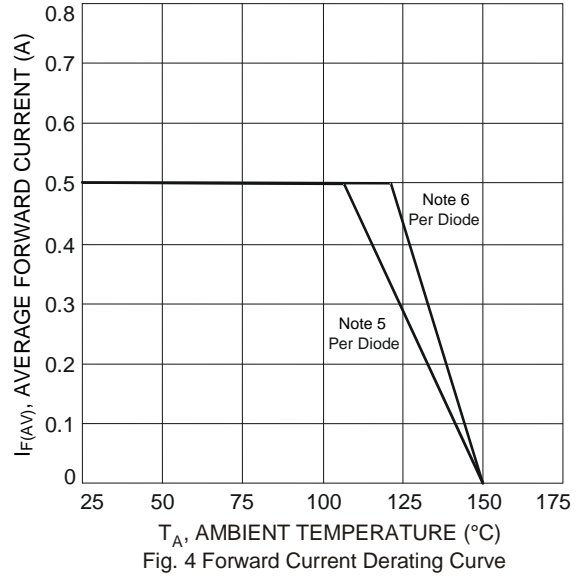
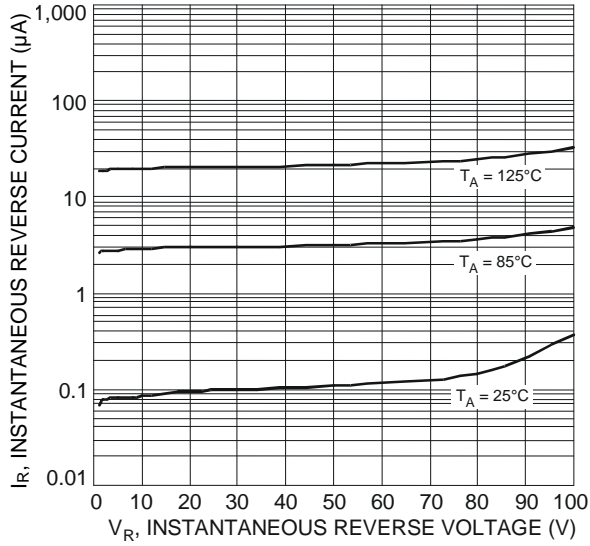

Fig. 2 Typical Forward Characteristics



Package Outline Dimensions

Please see <http://www.diodes.com/package-outlines.html> for the latest version.

U-DFN3030-4

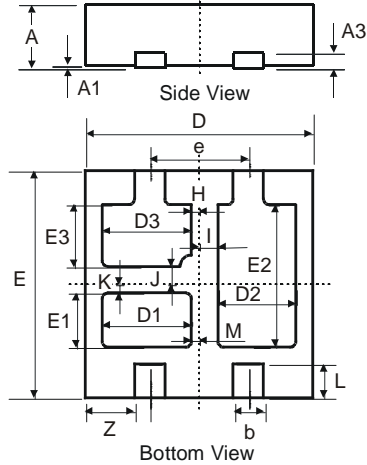

U-DFN3030-4							
Dim	Min	Max	Typ	Dim	Min	Max	Typ
A	0.57	0.63	0.60	E1	0.615	0.815	0.715
A1	0	0.05	0.02	E2	1.78	1.98	1.88
A3	-	-	0.15	E3	0.715	0.915	0.815
B	0.35	0.45	0.40	H	0.05	0.15	0.10
D	2.90	3.10	3.00	I	0.20	0.30	0.25
D1	1.075	1.275	1.175	J	0.185	0.285	0.235
D2	0.925	1.125	1.025	K	0.065	0.165	0.115
D3	1.075	1.275	1.175	L	0.30	0.60	0.45
E	2.90	3.10	3.00	M	0.05	0.15	0.10
e	-	-	1.30	Z	-	-	0.65

All Dimensions in mm

Suggested Pad Layout

Please see <http://www.diodes.com/package-outlines.html> for the latest version.

U-DFN3030-4

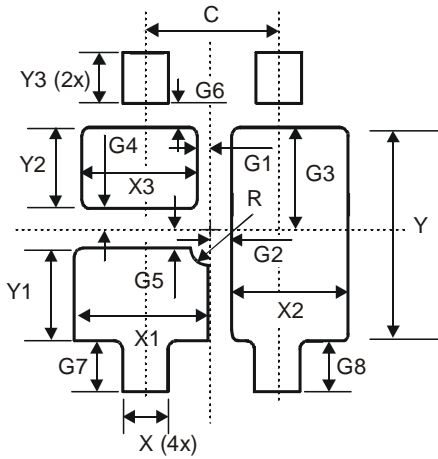

Dimensions	Value (in mm)
C	1.300
G1	0.100
G2	0.150
G3	0.830
G4	0.115
G5	0.135
G6	0.170
G7	0.500
G8	0.500
R	0.150
X	0.500
X1	1.375
X2	1.225
X3	1.175
Y	1.980
Y1	1.015
Y2	0.715
Y3	0.650

IMPORTANT NOTICE

DIODES INCORPORATED MAKES NO WARRANTY OF ANY KIND, EXPRESS OR IMPLIED, WITH REGARDS TO THIS DOCUMENT, INCLUDING, BUT NOT LIMITED TO, THE IMPLIED WARRANTIES OF MERCHANTABILITY AND FITNESS FOR A PARTICULAR PURPOSE (AND THEIR EQUIVALENTS UNDER THE LAWS OF ANY JURISDICTION).

Diodes Incorporated and its subsidiaries reserve the right to make modifications, enhancements, improvements, corrections or other changes without further notice to this document and any product described herein. Diodes Incorporated does not assume any liability arising out of the application or use of this document or any product described herein; neither does Diodes Incorporated convey any license under its patent or trademark rights, nor the rights of others. Any Customer or user of this document or products described herein in such applications shall assume all risks of such use and will agree to hold Diodes Incorporated and all the companies whose products are represented on Diodes Incorporated website, harmless against all damages.

Diodes Incorporated does not warrant or accept any liability whatsoever in respect of any products purchased through unauthorized sales channel. Should Customers purchase or use Diodes Incorporated products for any unintended or unauthorized application, Customers shall indemnify and hold Diodes Incorporated and its representatives harmless against all claims, damages, expenses, and attorney fees arising out of, directly or indirectly, any claim of personal injury or death associated with such unintended or unauthorized application.

Products described herein may be covered by one or more United States, international or foreign patents pending. Product names and markings noted herein may also be covered by one or more United States, international or foreign trademarks.

This document is written in English but may be translated into multiple languages for reference. Only the English version of this document is the final and determinative format released by Diodes Incorporated.

LIFE SUPPORT

Diodes Incorporated products are specifically not authorized for use as critical components in life support devices or systems without the express written approval of the Chief Executive Officer of Diodes Incorporated. As used herein:

A. Life support devices or systems are devices or systems which:

1. are intended to implant into the body, or
2. support or sustain life and whose failure to perform when properly used in accordance with instructions for use provided in the labeling can be reasonably expected to result in significant injury to the user.

B. A critical component is any component in a life support device or system whose failure to perform can be reasonably expected to cause the failure of the life support device or to affect its safety or effectiveness.

Customers represent that they have all necessary expertise in the safety and regulatory ramifications of their life support devices or systems, and acknowledge and agree that they are solely responsible for all legal, regulatory and safety-related requirements concerning their products and any use of Diodes Incorporated products in such safety-critical, life support devices or systems, notwithstanding any devices- or systems-related information or support that may be provided by Diodes Incorporated. Further, Customers must fully indemnify Diodes Incorporated and its representatives against any damages arising out of the use of Diodes Incorporated products in such safety-critical, life support devices or systems.

Copyright © 2016, Diodes Incorporated

www.diodes.com

单击下面可查看定价，库存，交付和生命周期等信息

[>>Diodes Incorporated\(达尔科技\)](#)