

BOOST CONTROLLER WITH 4-CHANNEL HIGH PRECISION CURRENT SOURCE

Description

The AL3065A is a high level integration boost controller with four channels for WLED backlight applications. It operates over a wide input voltage ranging from 4.5V to 33V.

The current of the four channels is simply programmed from 20mA to 400mA with an external resistor. The current match between any channels is $\pm 0.5\%$ (typical). Its operating frequency can be adjusted from 0.1MHz to 1MHz.

The AL3065A can be dimmed by one of the following modes: direct PWM dimming, PWM-to-analog dimming, or DC-to-analog dimming.

Robust protection features include cycle-by-cycle current limit, soft-start, UVLO, programmable OVP, OTP, open/short LED protection, Schottky diode short and open protection, inductor short-circuit protection, and V_{OUT} short protection.

The IC is available in SO-16 packages.

Pin Assignments

(Top View)

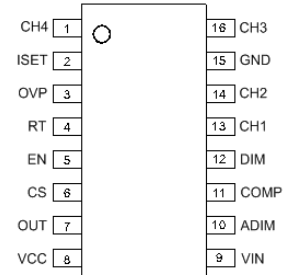

SO-16

Features

- Input Voltage Range: 4.5V to 33V
- Four High-Precision Current Sources
 - Current Matching $\pm 0.5\%$ (Typical)
 - LED String Current up to 250mA per Channel, 400mA Pulse Current
- Low Ripple for Low BOM Cost
- 6KV HBM ESD Class
- High Voltage Pins CS and OVP for Safety Test
- Supports Direct PWM Dimming, PWM-to-Analog Dimming, and DC-to-Analog Dimming Control
- Minimum PWM Dimming Duty Cycle can be 1/10,000 at 100Hz Dimming Frequency
- Built-in Below Comprehensive Protections
 - Overcurrent Protection (OCP)
 - Overvoltage Protection (OVP)
 - Overtemperature Protection (OTP)
 - Undervoltage Lock Out (UVLO)
 - LED Open/Short Protection
 - Schottky Diode/Inductor Short-Circuit Protection
 - V_{OUT} Short/Schottky Diode Open Protection
- Available in Pb-Free SO-16 Package
- **Totally Lead-Free & Fully RoHS Compliant (Notes 1 & 2)**
- **Halogen and Antimony Free. "Green" Device (Note 3)**

Applications

- LCD Monitor
- LCD Display Module
- LCD TV

Notes: 1. No purposely added lead. Fully EU Directive 2002/95/EC (RoHS), 2011/65/EU (RoHS 2) & 2015/863/EU (RoHS 3) compliant.
 2. See <https://www.diodes.com/quality/lead-free/> for more information about Diodes Incorporated's definitions of Halogen- and Antimony-free, "Green" and Lead-free.
 3. Halogen- and Antimony-free "Green" products are defined as those which contain <900ppm bromine, <900ppm chlorine (<1500ppm total Br + Cl) and <1000ppm antimony compounds.

Typical Applications Circuit

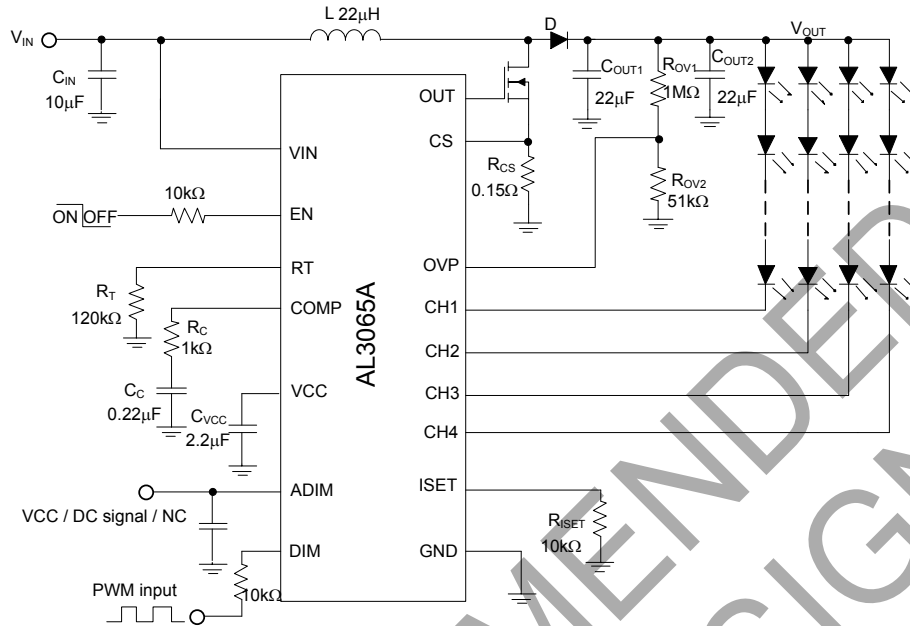

Pin Descriptions

Pin Number SO-16	Pin Name	Function
1	CH4	LED Current Sink 4. If not used—see 1- to 3-Channel Recommended Connections.
2	ISET	LED Current Set Pin. The corresponding maximum current of all four strings is set through connecting a resistor from this pin to GND.
3	OVP	Overvoltage Protection Pin. When the OVP pin voltage exceeds 2.0V, the OVP is triggered, and the power switch is turned off. When the OVP pin voltage drops below Hysteresis voltage, the OVP is released, and the power switch resumes normal operation.
4	RT	Frequency Control Pin.
5	EN	ON/OFF Control Pin. Forcing this pin voltage above 2.4V enables the IC while forcing below 0.5V shuts down the IC. When the IC is in shutdown mode, all functions are disabled to reduce the supply current below 3µA.
6	CS	Power Switch Current Sense Input.
7	OUT	Boost Converter Power Switch Gate Output. This pin outputs high voltage (5V) to drive the external N-MOSFET.
8	VCC	5V Linear Regulator Output Pin. This pin must be bypassed to GND with a ceramic capacitor.
9	VIN	Supply Input Pin. A capacitor (typical 10µF) must be connected between the VIN and GND to keep the DC input voltage constant.
10	ADIM	Analog Dimming Pin, which is used in conjunction with DIM. When a DC voltage between 0V and 1.5V is applied to this pin, analog dimming is achieved if DIM is tied HIGH. When a capacitor is connected between this pin and GND, the PWM signal applied to the DIM pin is filtered and modulates the output current. When this pin is connected to a HIGH level, direct PWM dimming is achieved.
11	COMP	Soft-Start and Control Loop Compensation.
12	DIM	PWM Dimming Control Pin, which is used in conjunction with ADIM. Apply the PWM signal to this pin. Tie this pin to logic HIGH level, for analog dimming.
13	CH1	LED Current Sink 1. If not used—see 1- to 3-Channel Recommended Connections.
14	CH2	LED Current Sink 2. If not used—see 1- to 3-Channel Recommended Connections.
15	GND	Ground.
16	CH3	LED Current Sink 3. If not used—see 1- to 3-Channel Recommended Connections.

Functional Block Diagram

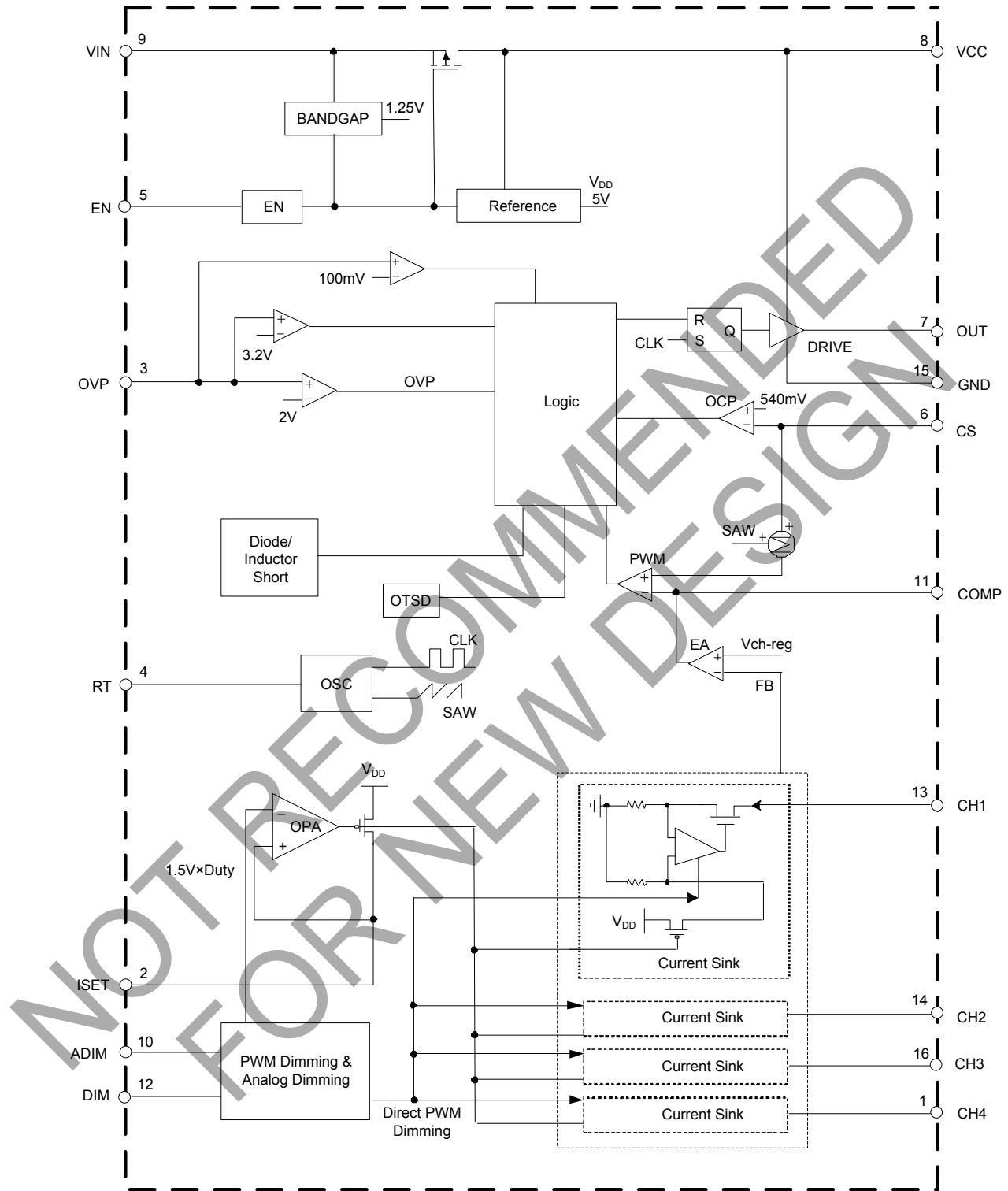

Absolute Maximum Ratings (@T_A = +25°C, unless otherwise specified.) (Notes 4 & 5)

Symbol	Parameter	Rating	Unit
V _{IN}	Input Voltage	-0.3 to 40	V
V _{EN}	EN Pin Voltage	-0.3 to 7	V
V _{CC}	VCC Pin Voltage	-0.3 to 7	V
V _{CH}	CH1 to CH4 Pins Voltage	-0.3 to 60	V
V _{CS}	CS Pin Voltage	-0.3 to 42	V
V _{COMP}	COMP Pin Voltage	-0.3 to 7	V
V _{ISET}	ISET Pin Voltage	-0.3 to 7	V
V _{OUT}	OUT Pin Voltage	-0.3 to 7	V
V _{OVP}	OVP Pin Voltage	-0.3 to 42	V
V _{RT}	RT Pin Voltage	-0.3 to 7	V
V _{ADIM}	ADIM Pin Voltage	-0.3 to 7	V
V _{DIM}	DIM Pin Voltage	-0.3 to 7	V
V _{GND}	GND Pin Voltage	-0.3 to 0.3	V
θ _{JA}	Thermal Resistance (Junction to Ambient) (Note 6)	79	°C/W
θ _{JC}	Thermal Resistance (Junction to Case) (Note 6)	10	°C/W
T _J	Operating Junction Temperature	+150	°C
T _{STG}	Storage Temperature	-65 to +150	°C
T _{LEAD}	Lead Temperature (Soldering, 10sec)	+260	°C
–	ESD (Charge Device Model, CDM)	2000	V
–	ESD (Human Body Model, HBM)	6000	V

- Notes:
- Stresses greater than those listed under *Absolute Maximum Ratings* can cause permanent damage to the device. These are stress ratings only and functional operation of the device at these or any other conditions beyond those indicated under *Recommended Operating Conditions* are not implied. Exposure to *Absolute Maximum Ratings* for extended periods can affect device reliability.
 - For better performance, the AL3065A must have high-voltage pins CS and OVP.
 - Device mounted on 2" × 2" FR-4 substrate PCB, 2oz copper, with minimum recommended pad layout.

Recommended Operating Conditions

Symbol	Parameter	Min	Max	Unit
V _{IN}	Input Voltage	4.5	33	V
f _o	Operating Frequency	0.1	1	MHz
I _{CH}	LED Channel Current	20	400	mA
f _{PWM}	PWM Dimming Frequency	0.1	25	kHz
T _A	Operating Ambient Temperature	-40	+85	°C

Electrical Characteristics (@ $T_A = +25^\circ\text{C}$, $V_{IN} = 12\text{V}$, $V_{EN} = 5\text{V}$, unless otherwise specified.)

Symbol	Parameter	Condition	Min	Typ	Max	Unit
Input Supply						
V_{IN}	Input Voltage	—	4.5	—	33	V
I_Q	Quiescent Current	No Switching	—	3	—	mA
I_{SHDN}	Shutdown Supply Current	$V_{EN} = 0\text{V}$	—	1	—	μA
V_{UVLO}	Under-Voltage Lockout Voltage	V_{IN} Rising	3.7	4.0	4.3	V
V_{HYS}	UVLO Hysteresis	—	—	200	—	mV
V_{CC} Regulator						
V_{CC}	V_{CC} Voltage	$V_{IN} \geq 5.5\text{V}$	—	5	—	V
		$V_{IN} < 5.5\text{V}$	—	$V_{IN}-0.5$	—	V
t_{RISE}	OUT Pin Rise Time	OUT Pin Load = 1nF	—	30	—	ns
t_{FALL}	OUT Pin Fall Time	OUT Pin Load = 1nF	—	30	—	ns
—	Load Regulation	Load = 0 to 30mA	—	5	—	mV/mA
—	Line Regulation	$V_{IN} = 12\text{V}$ to 33V	—	0.3	—	mV/V
High-Frequency Oscillator						
f_{OSC1}	Switch Frequency	$R_T = 100\text{k}\Omega$	—	500	—	kHz
—	Switch Frequency Range	—	0.1	—	1	MHz
D_{MAX}	Max. Duty Cycle	$R_T = 100\text{k}\Omega$	80	90	—	%
t_{ON_TIME}	Minimum On-Time	—	—	200	—	ns
Enable Logic and Dimming Logic						
V_{EN_H}	EN High Voltage	—	2.4	—	—	V
V_{EN_L}	EN Low Voltage	—	—	—	0.5	V
V_{DIM_H}	PWM Logic for External Dimming	—	2.5	—	—	V
V_{DIM_L}		—	—	—	0.3	V
V_{ADIM}	ADIM Voltage Range for DC Dimming	—	0	—	1.5	V
R_{ADIM}	ADIM Output Resistance	—	70	100	130	$\text{k}\Omega$
Power Switch Drive						
V_{LIMIT}	Current Limit Threshold Voltage	—	480	540	600	mV
V_{LIMIT2}	D/L Short Threshold Voltage	—	720	800	880	mV
t_{LEB}	Current Sense LEB Time (Note 7)	—	80	100	150	ns
Compensation and Soft-Start (COMP Pin)						
I_{O_H}	Sourcing Current	$V_{COMP} = 0.5\text{V}$	—	120	—	μA
I_{O_L}	Sinking Current	$V_{COMP} = 2\text{V}$	—	120	—	μA

Electrical Characteristics (continued) (@T_A = +25°C, V_{IN} = 12V, V_{EN} = 5V, unless otherwise specified.)

Symbol	Parameter	Condition	Min	Typ	Max	Unit
Overvoltage Protection						
V _{OVP}	OVP Threshold Voltage	V _{OUT} Rising	1.9	2.0	2.1	V
V _{OVP_HYS}	OVP Hysteresis	—	—	200	—	mV
V _{OVP_SH}	Shutdown Under Abnormal Condition	—	3.0	3.2	3.4	V
Current Source						
I _{CH}	Regulation Current per Channel	R _{ISET} =21.8kΩ, I _{CH} =55mA Analog Dimming PWM Duty Cycle=100%	52.3	55	57.7	mA
I _{CH_MATCH}	LED Current Matching Between Each String (Note 8)	—	—	0.5	1	%
I _{CH}	Regulation Current per Channel	Analog Dimming PWM Duty Cycle=10%	4	5.5	7	mA
I _{CH_MATCH}	LED Current Matching Between Each String (Note 8)	—	—	1.5	3	%
V _{LED_REG}	Minimum LED Regulation Voltage	I _{CH} = 120mA	—	500	—	mV
I _{LED_LEAK}	CH1 to CH4 Leakage Current	V _{EN} = 0V, V _{LED} = 37V	—	0.1	1	μA
V _{LED_S}	LED Short Protection Threshold	—	8.0	8.7	9.5	V
Overtemperature Protection						
T _{OTSD}	Thermal Shutdown Temperature (Note 7)	—	+155	+160	+165	°C
T _{HYS}	Thermal Shutdown Temperature Hysteresis (Note 7)	—	—	+30	—	°C

- Notes:
7. Guaranteed by Design.
 8.
$$I_{CH_MATCH} = \frac{I_{MAX} - I_{MIN}}{2 \times I_{AVG}} \times 100\%$$

NOT RECOMMENDED FOR NEW DESIGN

Performance Characteristic (@ $T_A = +25^\circ\text{C}$, $V_{IN} = 24\text{V}$, $V_{EN} = V_{DIM} = 5\text{V}$, unless otherwise specified)

Frequency vs. RT Resistor

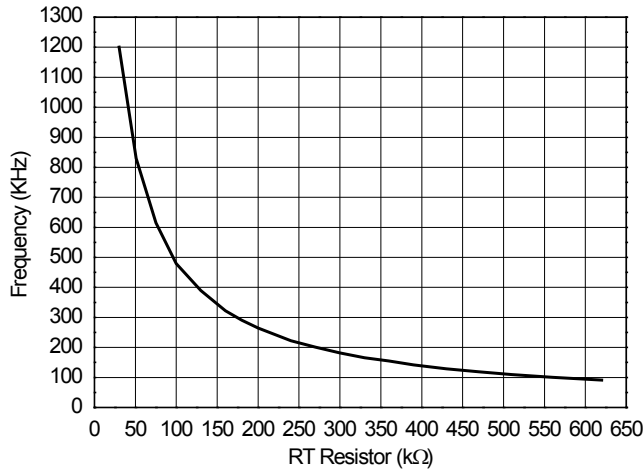

VCC Voltage vs. VIN pin Voltage

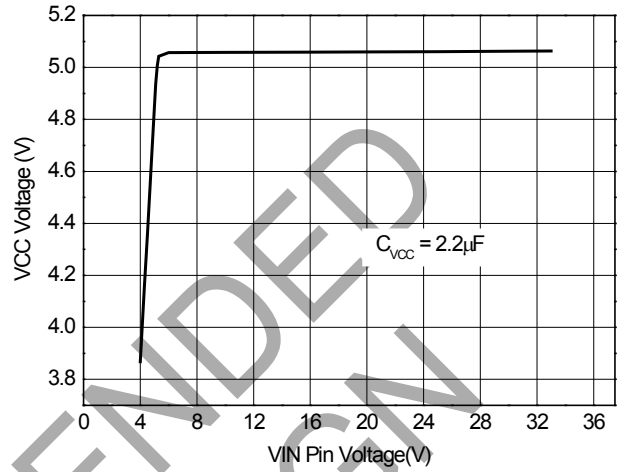

CHX Pin Regulation Voltage vs. Output Current / CH

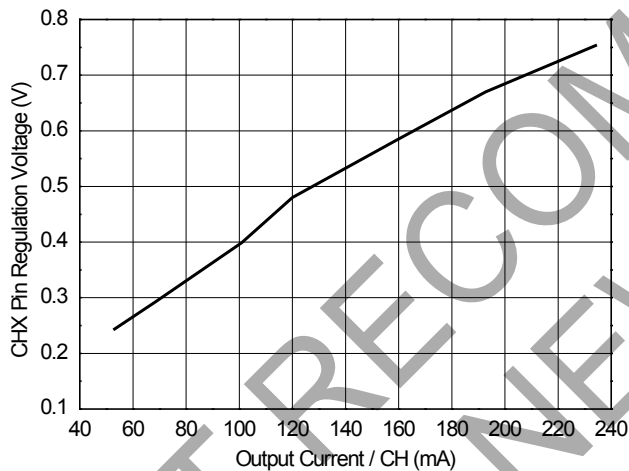

CHX Pin Regulation Voltage vs. Temperature

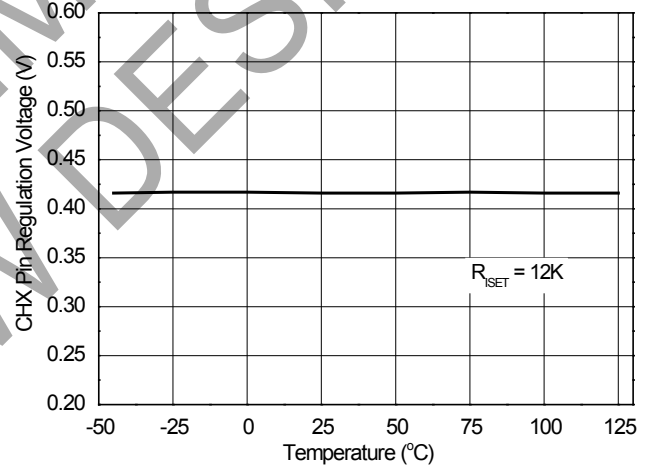

Channel Current vs. Channel

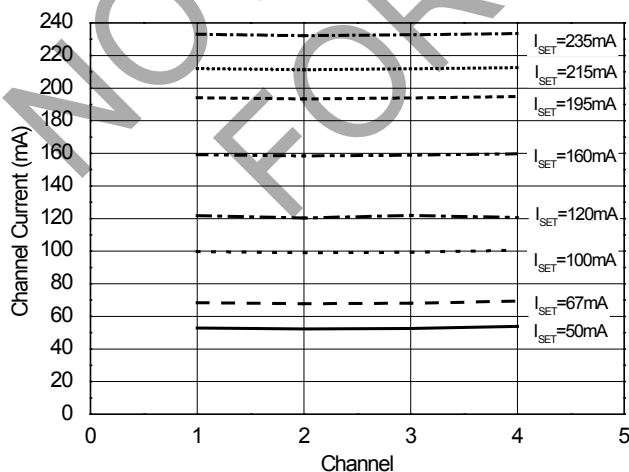

**Direct PWM Dimming @ $f_{PWM} = 100\text{Hz}$
Channel Current vs. Duty Cycle**

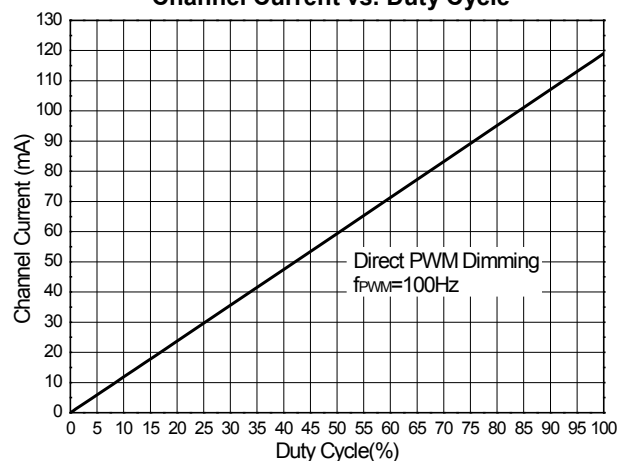

Performance Characteristic (continued) (@ $T_A = +25^\circ\text{C}$, $V_{IN} = 24\text{V}$, $V_{EN} = V_{DIM} = 5\text{V}$, unless otherwise specified.)

**Direct PWM Dimming @ $f_{PWM} = 20\text{kHz}$
Channel Current vs. Duty Cycle**

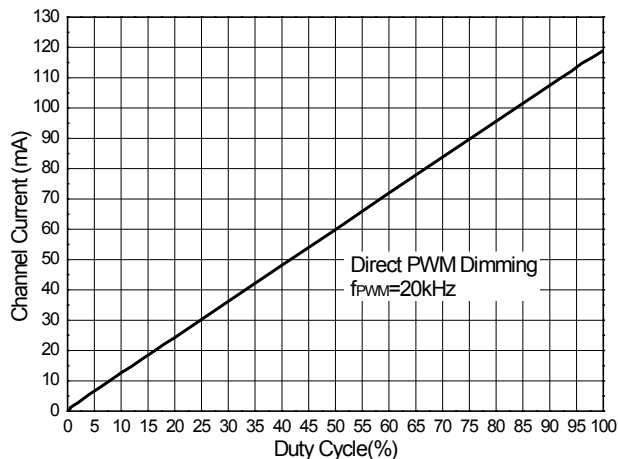

**PWM-to-Analog Dimming @ $f_{PWM} = 20\text{kHz}$
Channel Current vs. Duty Cycle**

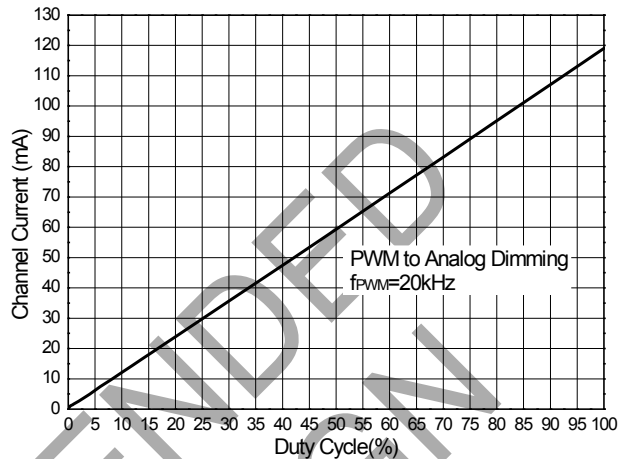

**DC-to-Analog Dimming
Channel Current vs. ADIM Pin Voltage**

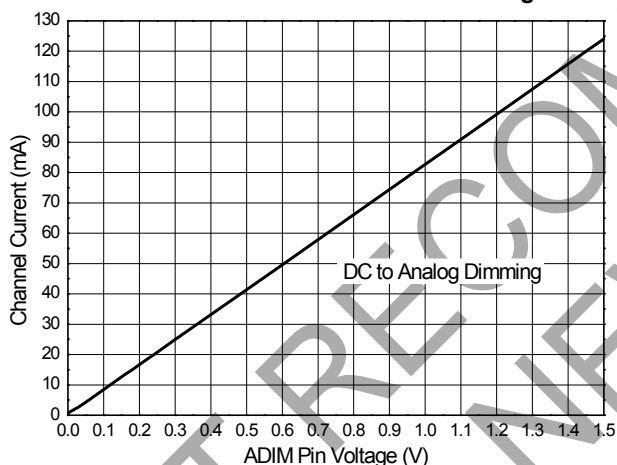

Steady State

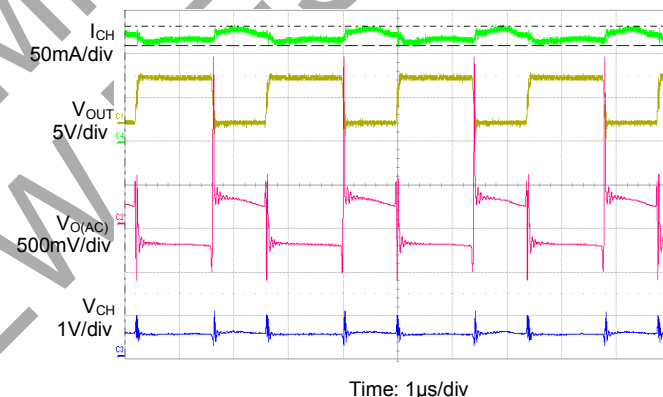

System Startup

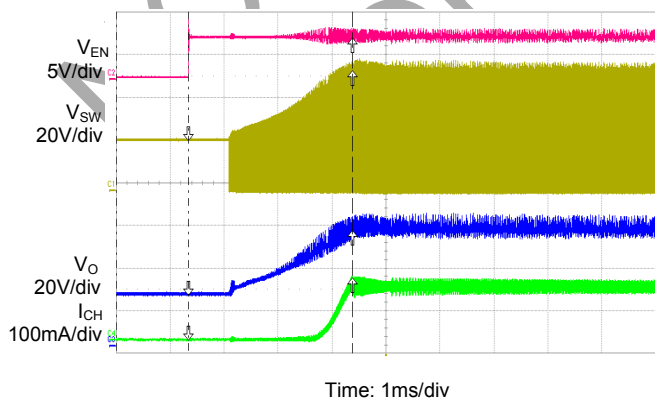

Direct PWM Dimming

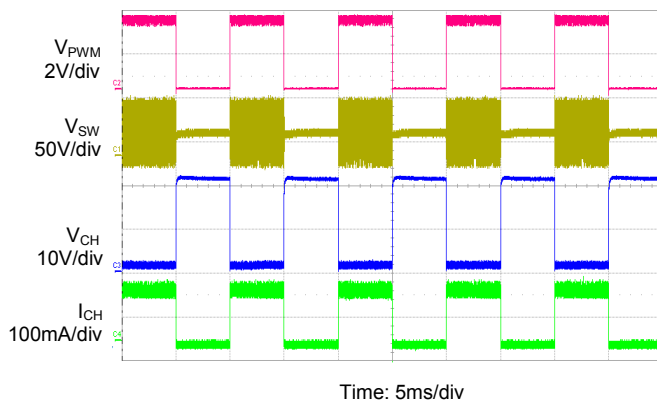

Performance Characteristic (continued) (@ $T_A = +25^\circ\text{C}$, $V_{IN} = 24\text{V}$, $V_{EN} = V_{DIM} = 5\text{V}$, unless otherwise specified.)

PWM-to-Analog Dimming

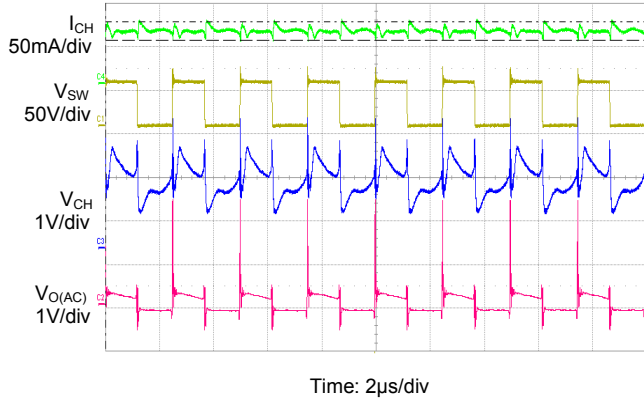

LED Short Protection

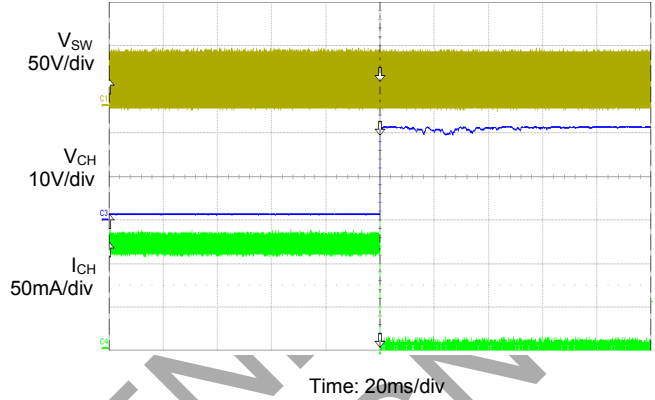

LED Open Protection

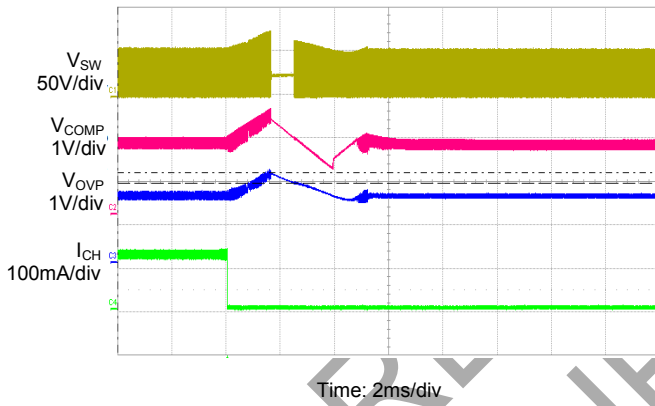

Schottky/Inductor Short Protection

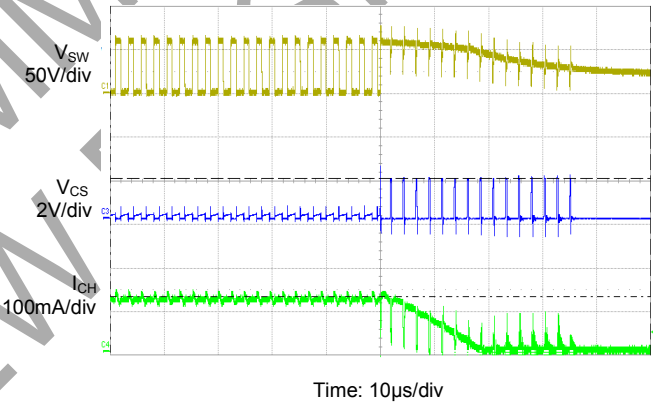

VOUT Short/Diode Open Protection

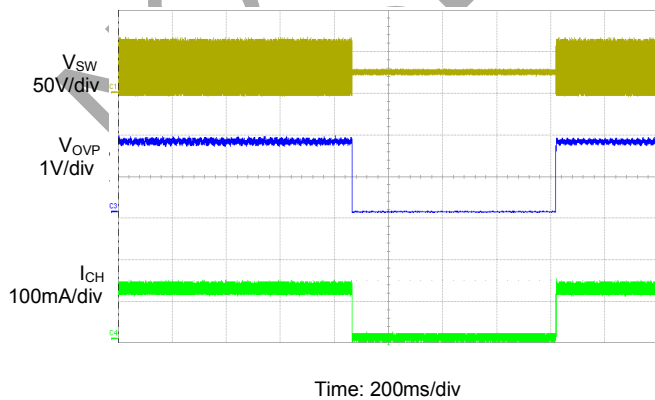

Overtemperature Protection

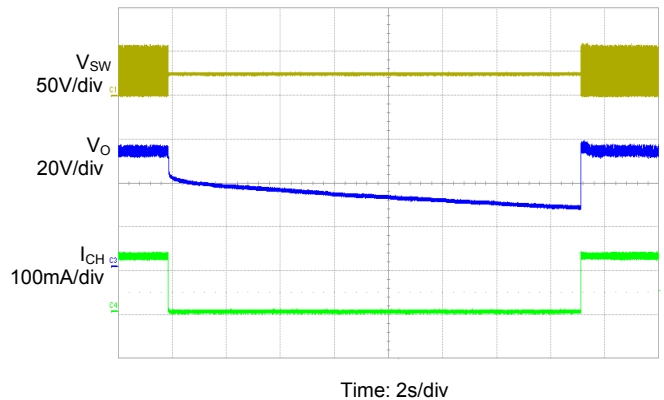

Application Information

Enable Pin

The AL3065A is enabled when the voltage at EN pin is greater than approximately 2.4V and disabled when lower than 0.5V.

Operating Frequency Selection

An external resistor R_T , placed between R_T pin and GND, can be used to set the operating frequency. The operating frequency ranges from 100kHz to 1MHz. The high-frequency operation optimizes the regulator for the smallest-sized component application while low-frequency operation can help to reduce switch loss. The approximate operating frequency is expressed in the following equation:

$$f_{OSC} [MHz] = \frac{52}{R_T [K\Omega]}$$

LED Output Current Setting

The maximum LED current per channel can be adjusted up to 400mA via ISET pin. When $\geq 400mA$ current is required in application, two or more channels can be paralleled to provide larger drive current. A resistor R_{ISET} is connected between ISET pin and GND to set the reference current I_{SET} . The LED current is expressed as follows:

$$I_{LED} [mA] = \frac{1200}{R_{ISET} [K\Omega]}$$

Desired I_{LED} (mA)	R_{ISET} (K Ω)
20	60
50	24
75	16
100	12
120	10
250	4.8

Three Types of Dimming Controls

1) Direct PWM Dimming Control

Compared to analog dimming, PWM dimming offers superior dimming resolution and reduces LED color shift. Tying ADIM to VCC pin enables direct PWM dimming. The PWM signal is applied to the DIM pin. The LED current of all enabled channels can be adjusted at the same time, and the LED brightness can be adjusted from $1\% \times I_{CH_MAX}$ to $100\% \times I_{CH_MAX}$.

During the *high level* period of PWM signal, the LED is turned on, and 100% of the current flows through the LED, and during the *low level* period of the PWM signal, the LED is turned off, and almost no current flows through the LED. Changing the average current through the LED can adjust the LED brightness.

The external PWM signal frequency applied to DIM pin can be 100Hz or higher, and the minimum duty PWM duty can be 1/10,000 at 100Hz dimming frequency.

2) PWM-to-Analog Dimming Control

When a capacitor is connected between ADIM pin and GND, the IC provides analog dimming function from PWM signal input of DIM pin. The capacitor forms a filter with the output resistance of ADIM. The output of this filter contains an average DC component thereby modulating the amplitude of the LED current.

3) DC-to-Analog Dimming Control

When a DC signal is connected to ADIM pin, the IC provides analog dimming. The amplitude of the LED current can be modified by varying the ADIM pin voltage between 0V and 1.5V. Tie the DIM pin to logic high level.

Application Information (continued)

1- to 3-Channel Recommended Connections

For applications using fewer than four LED strings, one option is to leave the unused channels open. However, LED open-circuit protection is triggered at each start up to disable the unused channels.

To avoid LED open-circuit protection at each start up, use the following recommended connections.

For applications using only one LED string, all four channels must be tied together, and the current setting for each channel is one quarter of the desired output current.

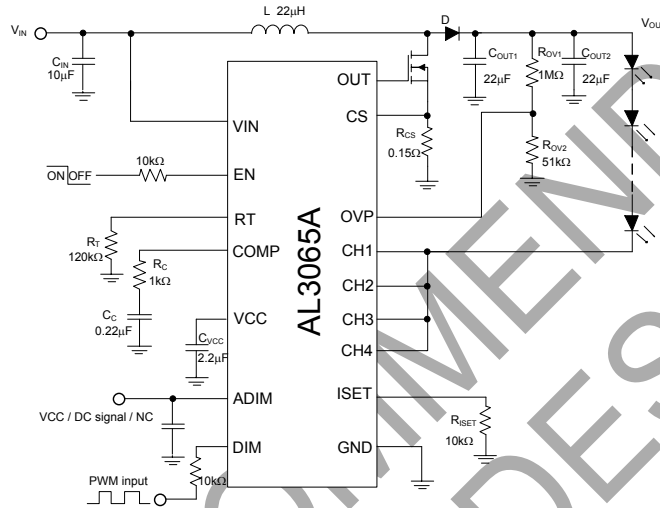

One Channel Recommended Connection

For applications using two LED strings, every two channels must be tied together (CH1&CH2, CH3&CH4), and the current setting for each channel is half of the desired output current of each LED string.

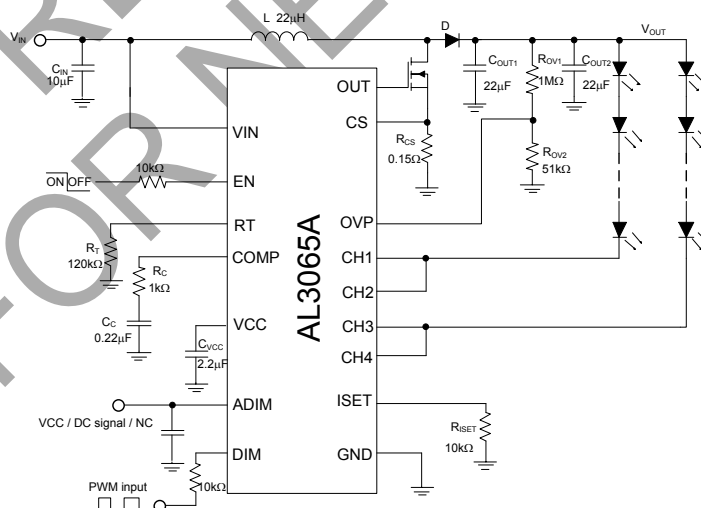

Two Channels Recommended Connection

Application Information (continued)

For applications using three LED strings, the AL3065A provides design flexibility by disabling the third channel, CH3 opened. A resistor R_T is required to be connected between RT pin and VCC pin instead of connecting between RT pin and GND pin. The three LED strings must be connected to CH1, CH2, and CH4 correspondingly.

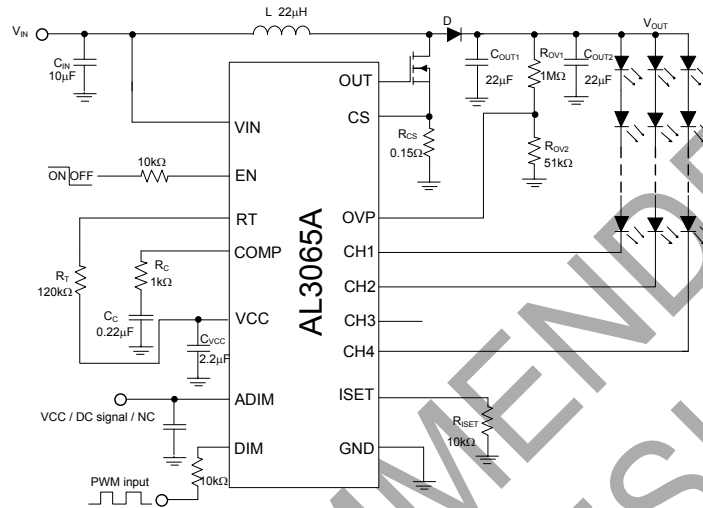

Three Channels Recommended Connection

NOT RECOMMENDED FOR NEW DESIGN

Application Information (continued)

This Device has a High Level of Integrated Built-In Protections:

1) Abnormal Condition

The AL3065A features shutdown at any abnormal condition protection circuit. For example, when the OVP pin voltage exceeds 3.2V, the IC is latched off. Toggle EN pin to restart the IC. This feature can be used to shut down the IC under any defined abnormal condition.

2) Overvoltage Protection

The AL3065A integrates an OVP circuit. The OVP pin is connected to the center tap of voltage-divider (R_{OV1} and R_{OV2}) connected between high-voltage output and GND.

If the voltage at OVP pin exceeds 2.0V, which may result from open loop or excessive output voltage, all of the functions of the AL3065A are disabled with output voltage falling. The OVP hysteresis is 200mV.

3) Overcurrent Protection

The AL3065A integrates an OCP circuit. The CS pin is connected to the voltage-sensor resistor (R_{CS}) placed between the source of the MOSFET and GND. If the voltage at CS pin exceeds 0.54V, the MOSFET is turned off immediately and does not turn on until the next cycle begins.

4) LED Short /Open Circuit Protection

When any LED string is short, the voltage at any of the CH1 to CH4 pins exceeds a threshold of approximately 7.3V during normal operation, and the corresponding channel is latched off. Toggle V_{IN} or EN to reset the latch. LED short detecting logic priority is lower than open LED and OVP logic. The LED short detecting is triggered when $0.1V < V_{LED_MIN}$ under dimming on mode, and disabled when LED open occurs until output voltage resumes to the regulated voltage.

When any LED string is open, V_{OUT} boosts up until the voltage at OVP pin reaches an approximate threshold of 2.0V. The IC automatically ignores the open string, which has a corresponding pin voltage of less than 100mV, and the remaining string continues operation. If all strings are open, and the voltage at OVP pin reaches a threshold of 2.0V, the MOSFET drive gate turns off, and the IC shuts down and latches.

5) V_{OUT} Short and Open/Short Schottky Diode Protection

The AL3065A monitors the OVP pin, if the OVP pin voltage is less than 0.1V, MOSFET drive output will turn off. This protects the converter if the output Schottky diode is open or V_{OUT} is shorted to ground.

The AL3065A features Schottky diode/inductor short-circuit protection circuit. When the CS pin voltage exceeds 0.8V for more than 16 switching clocks, the IC is latched off. Toggle EN pin to restart the IC. The voltage of CS pin is monitored after a short delay of t_{LEB} .

6) V_{IN} Undervoltage Lockout Protection

The AL3065A provides an undervoltage lockout circuit to prevent the device from undefined status when it starts up. The UVLO circuit shuts down the device when V_{IN} drops below 3.8V. The UVLO circuit has 200mV hysteresis, which means the device starts up again when V_{IN} rises to 4.0V.

7) Overtemperature Protection

The AL3065A features overtemperature protection. If the junction temperature exceeds approximately +160°C, the IC shuts down until the junction temperature is less than approximately +140°C. When the IC is released from over temperature shutdown, it starts a soft-start process.

Ordering Information

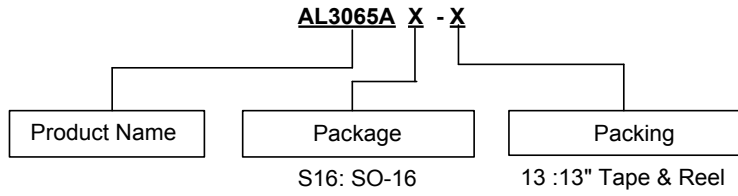

Part Number	Package Code	Package	13" Tape and Reel	
			Quantity	Part Number Suffix
AL3065AS16-13	S16 (Note 9)	SO-16	2500/Tape & Reel	-13

Note: 9. For packaging details, go to our website at <https://www.diodes.com/design/support/packaging/diodes-packaging/>.

Marking Information

(1) SO-16

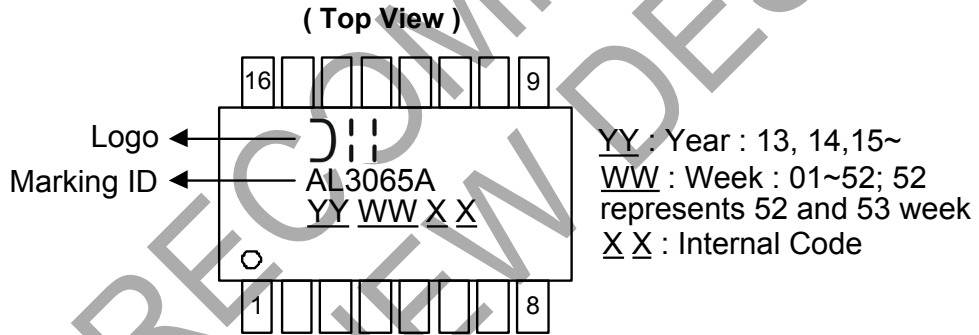

Package Outline Dimensions

Please see <http://www.diodes.com/package-outlines.html> for the latest version.

SO-16

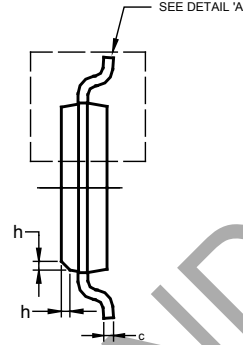
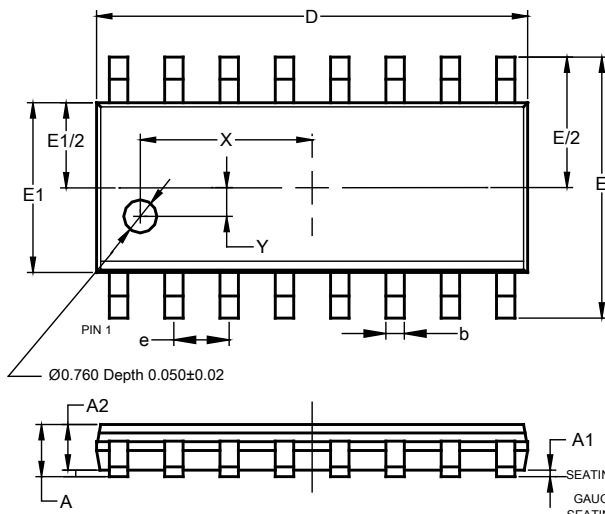

SO-16			
Dim	Min	Max	Typ
A	—	1.260	—
A1	0.10	0.23	—
A2	1.02	—	—
b	0.31	0.51	—
c	0.10	0.25	—
D	9.80	10.00	—
E	5.90	6.10	—
E1	3.80	4.00	—
e	1.27 BSC		
h	0.15	0.25	0.20
L	0.40	1.27	—
L1	1.04 REF		
L2	0.25 BSC		
R	0.07	—	—
R1	0.07	—	—
X	3.945 REF		
Y	0.661 REF		
θ	0°	8°	—
θ1	5°	15°	—
θ2	0°	—	—
All Dimensions in mm			

Suggested Pad Layout

Please see <http://www.diodes.com/package-outlines.html> for the latest version.

SO-16

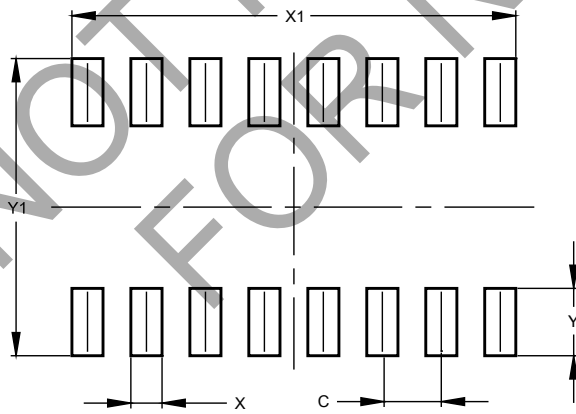

Dimensions	Value (in mm)
C	1.270
X	0.670
X1	9.560
Y	1.450
Y1	6.400

IMPORTANT NOTICE

1. DIODES INCORPORATED AND ITS SUBSIDIARIES ("DIODES") MAKE NO WARRANTY OF ANY KIND, EXPRESS OR IMPLIED, WITH REGARDS TO ANY INFORMATION CONTAINED IN THIS DOCUMENT, INCLUDING, BUT NOT LIMITED TO, THE IMPLIED WARRANTIES OF MERCHANTABILITY, FITNESS FOR A PARTICULAR PURPOSE OR NON-INFRINGEMENT OF THIRD PARTY INTELLECTUAL PROPERTY RIGHTS (AND THEIR EQUIVALENTS UNDER THE LAWS OF ANY JURISDICTION).
2. The Information contained herein is for informational purpose only and is provided only to illustrate the operation of Diodes products described herein and application examples. Diodes does not assume any liability arising out of the application or use of this document or any product described herein. This document is intended for skilled and technically trained engineering customers and users who design with Diodes products. Diodes products may be used to facilitate safety-related applications; however, in all instances customers and users are responsible for (a) selecting the appropriate Diodes products for their applications, (b) evaluating the suitability of the Diodes products for their intended applications, (c) ensuring their applications, which incorporate Diodes products, comply the applicable legal and regulatory requirements as well as safety and functional-safety related standards, and (d) ensuring they design with appropriate safeguards (including testing, validation, quality control techniques, redundancy, malfunction prevention, and appropriate treatment for aging degradation) to minimize the risks associated with their applications.
3. Diodes assumes no liability for any application-related information, support, assistance or feedback that may be provided by Diodes from time to time. Any customer or user of this document or products described herein will assume all risks and liabilities associated with such use, and will hold Diodes and all companies whose products are represented herein or on Diodes' websites, harmless against all damages and liabilities.
4. Products described herein may be covered by one or more United States, international or foreign patents and pending patent applications. Product names and markings noted herein may also be covered by one or more United States, international or foreign trademarks and trademark applications. Diodes does not convey any license under any of its intellectual property rights or the rights of any third parties (including third parties whose products and services may be described in this document or on Diodes' website) under this document.
5. Diodes products are provided subject to Diodes' Standard Terms and Conditions of Sale (<https://www.diodes.com/about/company/terms-and-conditions/terms-and-conditions-of-sales/>) or other applicable terms. This document does not alter or expand the applicable warranties provided by Diodes. Diodes does not warrant or accept any liability whatsoever in respect of any products purchased through unauthorized sales channel.
6. Diodes products and technology may not be used for or incorporated into any products or systems whose manufacture, use or sale is prohibited under any applicable laws and regulations. Should customers or users use Diodes products in contravention of any applicable laws or regulations, or for any unintended or unauthorized application, customers and users will (a) be solely responsible for any damages, losses or penalties arising in connection therewith or as a result thereof, and (b) indemnify and hold Diodes and its representatives and agents harmless against any and all claims, damages, expenses, and attorney fees arising out of, directly or indirectly, any claim relating to any noncompliance with the applicable laws and regulations, as well as any unintended or unauthorized application.
7. While efforts have been made to ensure the information contained in this document is accurate, complete and current, it may contain technical inaccuracies, omissions and typographical errors. Diodes does not warrant that information contained in this document is error-free and Diodes is under no obligation to update or otherwise correct this information. Notwithstanding the foregoing, Diodes reserves the right to make modifications, enhancements, improvements, corrections or other changes without further notice to this document and any product described herein. This document is written in English but may be translated into multiple languages for reference. Only the English version of this document is the final and determinative format released by Diodes.
8. Any unauthorized copying, modification, distribution, transmission, display or other use of this document (or any portion hereof) is prohibited. Diodes assumes no responsibility for any losses incurred by the customers or users or any third parties arising from any such unauthorized use.

Copyright © 2021 Diodes Incorporated

www.diodes.com

单击下面可查看定价，库存，交付和生命周期等信息

[>>Diodes Incorporated\(达达科技\(美台\)\)](#)