

600mA STEP-DOWN DC/DC CONVERTER WITH SYNCHRONOUS RECTIFIER

OBSOLETE - PART DISCONTINUED

Description

The AP3403 is a 2.0MHz fixed frequency, current mode, PWM synchronous buck (step-down) DC-DC converter, capable of driving a 600mA load with high efficiency, excellent line and load regulation. The high efficiency is easily configured by using an inductor, resistors and capacitors as the external components. Current mode control provides fast transient response and cycle-by-cycle current limit.

The AP3403 employs complete protection to ensure system security, including input Under Voltage Lock Out, Over Temperature Protection and hiccup mode Short Circuit Protection.

This IC is available in U-DFN1616-6 package.

Features

- High Efficiency Buck Power Converter
- Input Voltage Range: 2.3V to 5.5V
- Output Voltage Range: 0.7V to 5.5V
- Fixed 2.0MHz Oscillator Frequency
- Built-in Soft-start Time
- Built-in Over Current Protection
- Built-in Thermal Shutdown Function
- Built-in UVLO Function
- Hiccup Mode SCP
- Output Current: 600mA
- Package: U-DFN1616-6
- **Totally Lead-Free & Fully RoHS Compliant (Notes 1 & 2)**
- **Halogen and Antimony Free. "Green" Device (Note 3)**

Pin Assignments

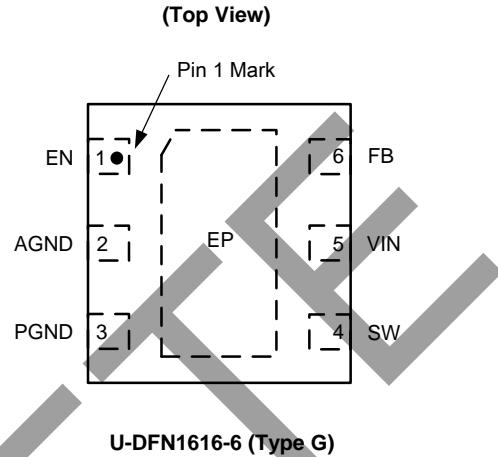

Applications

- Post DC-DC Voltage Regulation
- PDA and Notebook Computer

- Notes:
1. No purposely added lead. Fully EU Directive 2002/95/EC (RoHS) & 2011/65/EU (RoHS 2) compliant.
 2. See http://www.diodes.com/quality/lead_free.html for more information about Diodes Incorporated's definitions of Halogen- and Antimony-free, "Green" and Lead-free.
 3. Halogen- and Antimony-free "Green" products are defined as those which contain <900ppm bromine, <900ppm chlorine (<1500ppm total Br + Cl) and <1000ppm antimony compounds.

Typical Applications Circuit

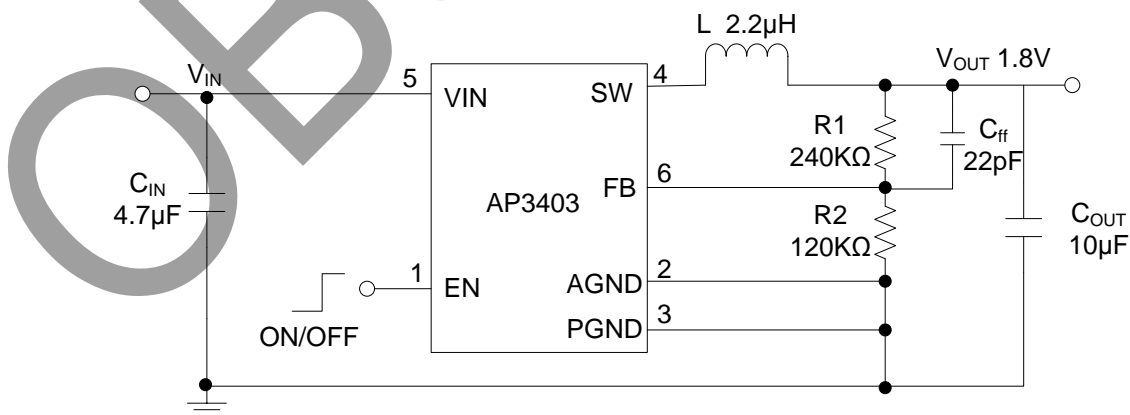

Pin Descriptions

Pin Number	Pin Name	Function
1	EN	Control input pin. EN is a digital input that turns the regulator on or off. Drive EN high to turn the regulator on. Drive low to turn the regulator off.
2	AGND	Signal Ground Pin
3	PGND	Power Ground Pin
4	SW	Power switch output pin. This pin is connected to the inductor.
5	VIN	Supply power input pin. A capacitor should be connected between VIN pin and GND - to keep the input voltage constant.
6	FB	Feedback pin. This pin is connected to an external resistor divider to program the system output voltage.

Functional Block Diagram

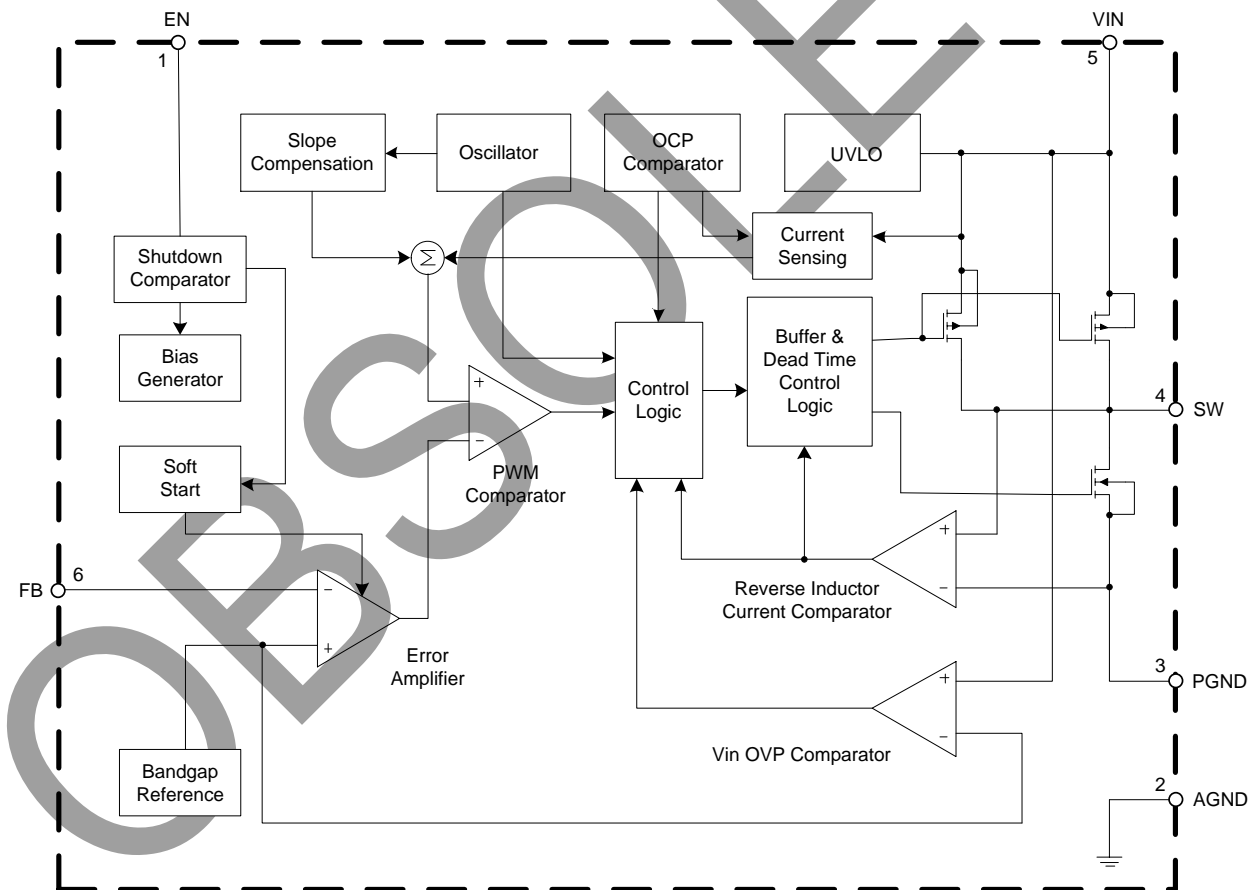

OBSOLETE - PART DISCONTINUED

Absolute Maximum Ratings (Note 4)

Symbol	Parameter	Rating	Unit
V _{IN}	VIN Input Voltage	-0.3 to 6.5	V
V _{SW}	SW Pin Voltage	-0.3 to V _{IN} + 0.3	V
V _{EN}	EN Pin Input Voltage	-0.3 to 6.5	V
V _{FB}	VFB Pin Voltage	-0.3 to 6.5	V
I _{SW}	SW Pin Output Current	1	A
P _D	Power Dissipation (Standard Land Pattern)	640	mW
T _{STG}	Storage Temperature Range	-55 to +125	°C
V _{HBM}	ESD (Human Body Model)	2000	V

Note 4: Stresses greater than those listed under "Absolute Maximum Ratings" may cause permanent damage to the device. These are stress ratings only, and functional operation of the device at these or any other conditions beyond those indicated under "Recommended Operating Conditions" is not implied. Exposure to "Absolute Maximum Ratings" for extended periods may affect device reliability.

Recommended Operating Conditions (@T_A = +25°C, unless otherwise specified.)

Symbol	Parameter	Min	Max	Unit
V _{IN}	Input Voltage	2.3	5.5	V
T _A	Operating Ambient Temperature	-40	+85	°C

Electrical Characteristics ($V_{IN} = V_{EN} = 3.6V$ ($V_{OUT} \leq 2.6V$), $V_{IN} = V_{EN} = V_{OUT}+1V$ ($V_{OUT} > 2.6V$), unless otherwise specified. Specification with standard typeface are for $T_A = +25^\circ C$, and those in **boldface** type apply over the full operating temperature range ($T_A = -40^\circ C$ to $+85^\circ C$))

Symbol	Parameter	Conditions	Min	Typ	Max	Unit
V_{IN}	Input Voltage	$1.0V \leq V_{OUT}$	2.3	–	5.5	V
		$0.9V \leq V_{OUT} < 1.0V$	2.3	–	5.25	
		$0.7V \leq V_{OUT} < 0.9V$	2.3	–	4.5	
I_{DD}	Supply Current	$V_{IN} = V_{EN} = V_{FB} = 3.6V$	–	32	45	μA
I_{STDB}	Standby Current	$V_{IN} = 5.5V, V_{EN} = 0V$	–	0	5	μA
V_{UVLO}	Input UVLO Threshold	V_{IN} Rising	2.0	2.1	2.2	V
V_{HYS}	Input UVLO Hysteresis	–	–	0.1	–	V
V_{ENH}	EN Active Threshold Voltage	$V_{IN} = 5.5V$	1.0	–	–	V
V_{ENL}	EN Shutdown Threshold Voltage	$V_{IN} = 2.3V$	–	–	0.4	V
V_{FB}	Feedback Voltage	$V_{IN} = V_{EN} = 3.6V$	0.591	0.600	0.609	V
I_{FBH}	FB High Input Current	$V_{IN} = V_{FB} = 5.5V$ $V_{EN} = 0V$	-1	0	1	μA
I_{FBL}	FB Low Input Current	$V_{EN} = V_{FB} = 0V$ $V_{IN} = 5.5V$	-1	0	1	μA
R_{ONH}	High-side Switch On-resistance	$V_{IN} = 3.6V$ $I_{SW} = 100mA$	–	380	–	$m\Omega$
R_{ONL}	Low-side Switch On-resistance	$V_{IN} = 3.6V$ $I_{SW} = 100mA$	–	300	–	$m\Omega$
I_{LIMH}	SW Current Limit	$V_{IN} = V_{EN} = 3.6V$	800	1000	–	mA
f_{OSC}	Oscillator Frequency	–	1.7	2.0	2.3	MHz
D_{MAX}	Max. Duty Cycle	–	100	–	–	%
T_{OTSD}	Thermal Shutdown	–	–	+140	–	$^\circ C$
T_{HYS}	Thermal Shutdown Hysteresis	–	–	+40	–	$^\circ C$
t_{SS}	Soft-start Time	$V_{IN} = V_{EN} = 3.6V$	–	150	300	μs

OBSOLETE – PART DISCONTINUED

Performance Characteristics ($T_A = +25^\circ\text{C}$, $V_{IN} = 3.6\text{V}$, $V_{OUT} = 1.8\text{V}$, unless otherwise specified.)

Efficiency vs. Output Current

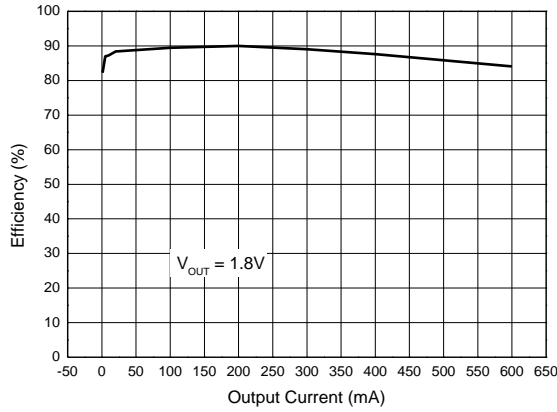

Output Voltage vs. Output Current

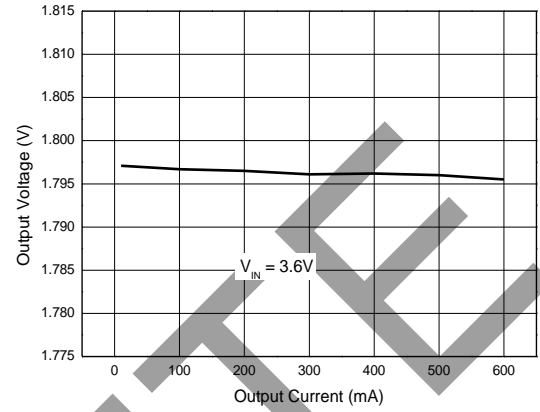

Supply Current vs. Input Voltage

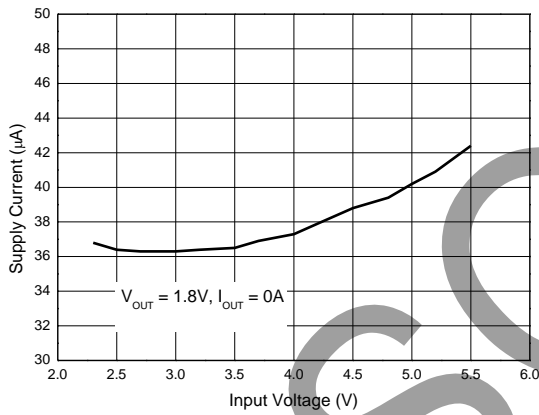

Feedback Voltage vs. Temperature

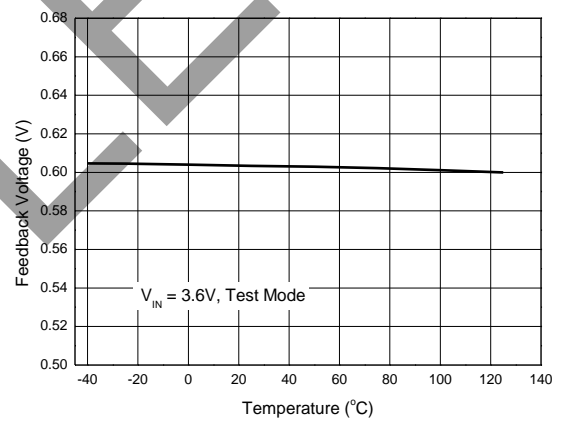

PMOS $R_{DS(on)}$ vs. Temperature

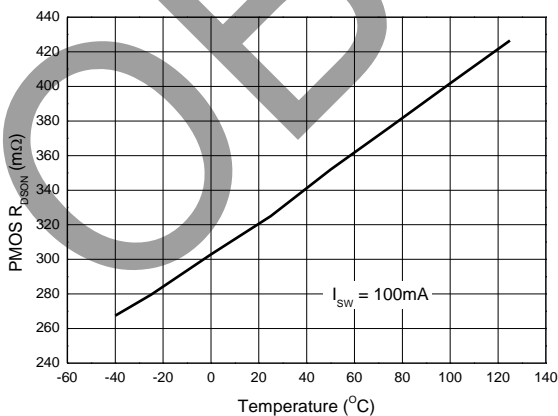

NMOS $R_{DS(on)}$ vs. Temperature

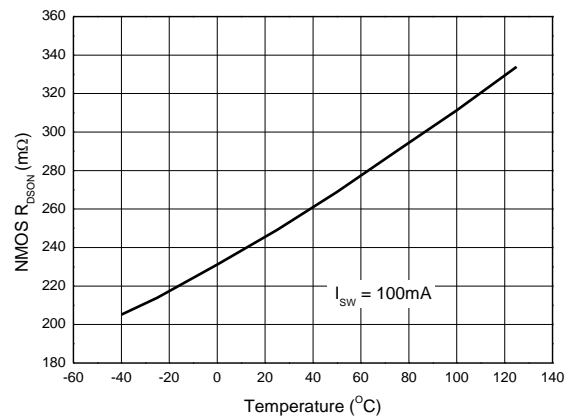

OBSOLETE - PART DISCONTINUED

Performance Characteristics (Cont. $T_A = +25^\circ\text{C}$, $V_{IN} = 3.6\text{V}$, $V_{OUT} = 1.8\text{V}$, unless otherwise specified.)

Output Ripple ($I_{OUT} = 0\text{A}$)

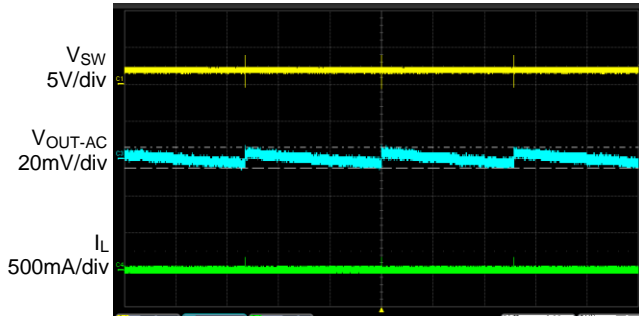

Time 1.6ms/div

Output Ripple ($I_{OUT} = 0.6\text{A}$)

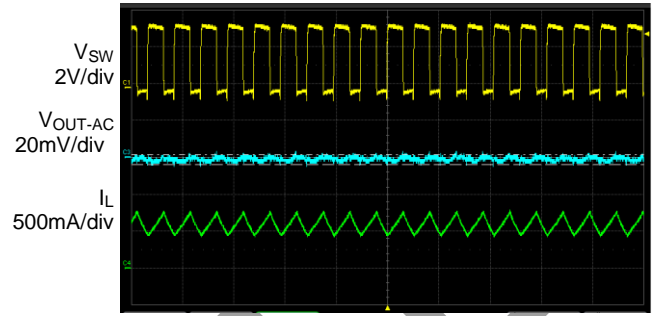

Time 1 μs /div

Enable Turn on Characteristic
(Resistance Load, $R_{LOAD} = 3\Omega$)

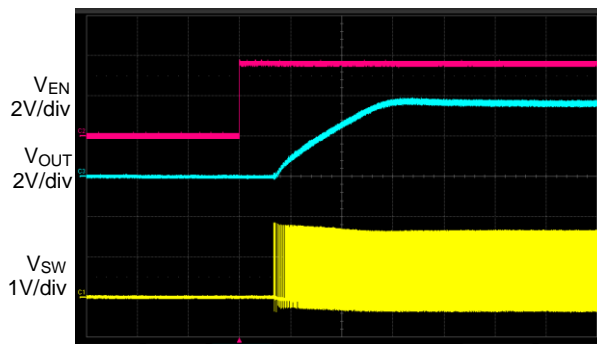

Time 50 μs /div

Enable Turn off Characteristic
(Resistance Load, $R_{LOAD} = 3\Omega$)

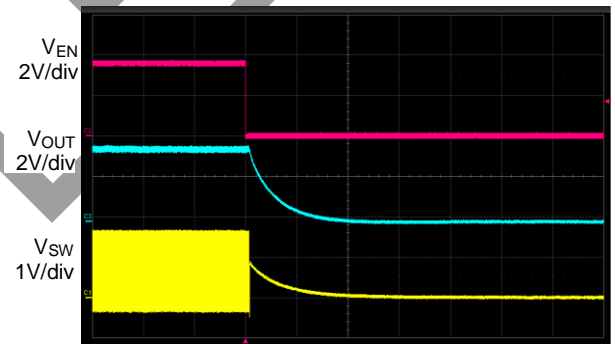

Time 50 μs /div

Short Current Protection
(Resistance Load, $R_{LOAD} = 3\Omega$)

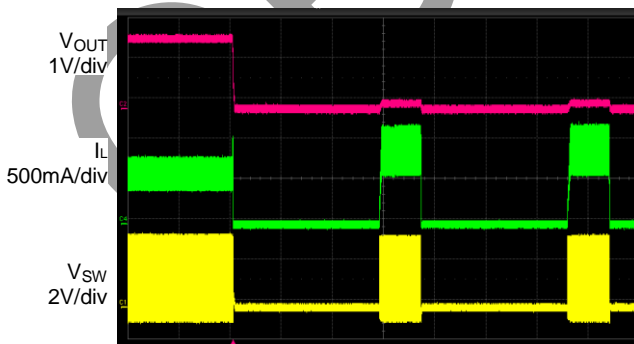

Time 200 μs /div

SCP Recovery
(Resistance Load, $R_{LOAD} = 3\Omega$)

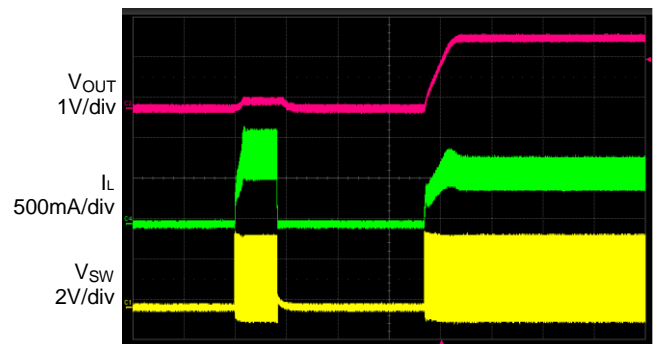

Time 200 μs /div

OBSOLETE - PART DISCONTINUED

OBsolete - PART DISCONTINUED

Application Information

Please refer to the Typical Applications Circuit, and to set the circuit parameters please refer to the following descriptions.

Under Voltage Lockout (UVLO) Circuit

When the V_{IN} drops lower than the UVLO detector threshold, the UVLO circuit starts to operate, V_{REF} stops, and high-side switch and low-side switch built-in switch transistors turn "OFF". As a result, V_{OUT} drops according to the C_{OUT} capacitance value and the load. When the V_{IN} is rising higher than UVLO released voltage, the IC will restart the operation.

Short Circuit Protection and Recovery

When the AP3403 output node is shorted to GND, as V_{FB} drops under 0.3V, the chip will enter hiccup mode to protect itself, when short circuit is removed, and V_{FB} rises over 0.4V, the AP3403 recovers to normal operation again. If the AP3403 reaches OCP threshold while short circuit, the AP3403 will enter cycle by cycle current limit mode until the current under OCP threshold.

Input Over Voltage Protection

When input voltage of AP3403 is near 6.25V, the IC will enter Input-Over-Voltage-Protection. It would be shut down and there will be no output voltage in this state. As the input voltage goes down below 6V, it will leave input OVP and recover the output voltage.

Over Temperature Protection

The internal thermal temperature protection circuitry is provided to protect the integrated circuit in the event that the maximum junction temperature is exceeded. When the junction temperature exceeds +140°C, it shuts down the internal control circuit and switching power MOSFET. The AP3403 will restart automatically under the control of soft start circuit when the junction temperature decreases to +100°C.

Ordering Information

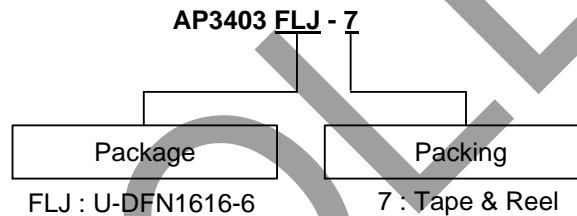

Part Number	Package Code	Packaging	7" Tape and Reel	
			Quantity	Part Number Suffix
AP3403FLJ-7	FLJ	U-DFN1616-6	3000/Tape & Reel	-7

Marking Information

U-DFN1616-6 (Type G)

(Top View)

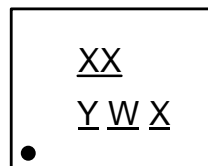

- XX : Identification Code
- Y : Year : 0~9
- W : Week : A~Z : 1~26 week;
a~z : 27~52 week; z represents 52 and 53 week
- X : Internal Code

Part Number	Package	Identification Code
AP3403FLJ-7	U-DFN1616-6	DE

Package Outline Dimensions (All dimensions in mm (inch).)

Please see AP02002 at <http://www.diodes.com/datasheets/ap02002.pdf> for latest version.

(1) Package Type: U-DFN1616-6 (Type G)

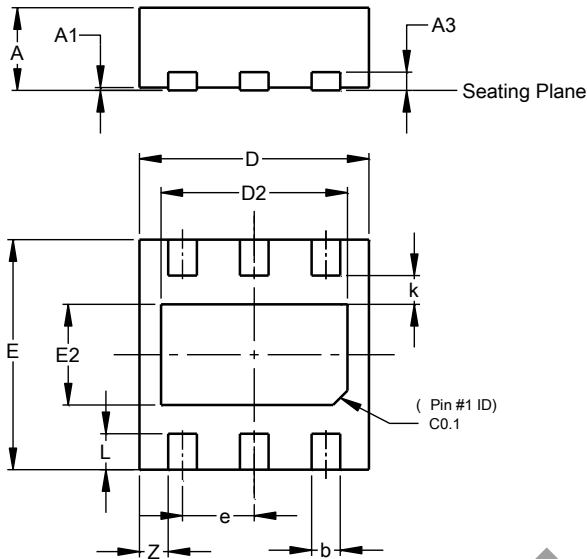

U-DFN1616-6 (Type G)			
Dim	Min	Max	Typ
A	0.50	0.60	0.56
A1	0.00	0.05	0.02
A3	--	--	0.203
b	0.15	0.25	0.20
D	1.55	1.65	1.60
D2	1.20	1.40	1.30
e	--	--	0.50
E	1.55	1.65	1.60
E2	0.60	0.80	0.70
k	--	--	0.20
L	0.20	0.30	0.25
z	--	--	0.20
All Dimensions in mm			

Suggested Pad Layout

Please see AP02001 at <http://www.diodes.com/datasheets/ap02001.pdf> for the latest version.

(1) Package Type: U-DFN1616-6 (Type G)

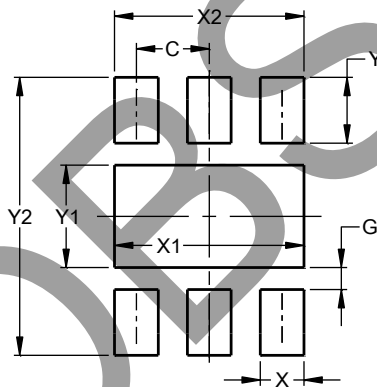

Dimensions	Value (in mm)
C	0.500
G	0.150
X	0.300
X1	1.300
X2	1.300
Y	0.450
Y1	0.700
Y2	1.900

OBSOLETE - PART DISCONTINUED

IMPORTANT NOTICE

DIODES INCORPORATED MAKES NO WARRANTY OF ANY KIND, EXPRESS OR IMPLIED, WITH REGARDS TO THIS DOCUMENT, INCLUDING, BUT NOT LIMITED TO, THE IMPLIED WARRANTIES OF MERCHANTABILITY AND FITNESS FOR A PARTICULAR PURPOSE (AND THEIR EQUIVALENTS UNDER THE LAWS OF ANY JURISDICTION).

Diodes Incorporated and its subsidiaries reserve the right to make modifications, enhancements, improvements, corrections or other changes without further notice to this document and any product described herein. Diodes Incorporated does not assume any liability arising out of the application or use of this document or any product described herein; neither does Diodes Incorporated convey any license under its patent or trademark rights, nor the rights of others. Any Customer or user of this document or products described herein in such applications shall assume all risks of such use and will agree to hold Diodes Incorporated and all the companies whose products are represented on Diodes Incorporated website, harmless against all damages.

Diodes Incorporated does not warrant or accept any liability whatsoever in respect of any products purchased through unauthorized sales channel. Should Customers purchase or use Diodes Incorporated products for any unintended or unauthorized application, Customers shall indemnify and hold Diodes Incorporated and its representatives harmless against all claims, damages, expenses, and attorney fees arising out of, directly or indirectly, any claim of personal injury or death associated with such unintended or unauthorized application.

Products described herein may be covered by one or more United States, international or foreign patents pending. Product names and markings noted herein may also be covered by one or more United States, international or foreign trademarks.

This document is written in English but may be translated into multiple languages for reference. Only the English version of this document is the final and determinative format released by Diodes Incorporated.

LIFE SUPPORT

Diodes Incorporated products are specifically not authorized for use as critical components in life support devices or systems without the express written approval of the Chief Executive Officer of Diodes Incorporated. As used herein:

A. Life support devices or systems are devices or systems which:

1. are intended to implant into the body, or
2. support or sustain life and whose failure to perform when properly used in accordance with instructions for use provided in the labeling can be reasonably expected to result in significant injury to the user.

B. A critical component is any component in a life support device or system whose failure to perform can be reasonably expected to cause the failure of the life support device or to affect its safety or effectiveness.

Customers represent that they have all necessary expertise in the safety and regulatory ramifications of their life support devices or systems, and acknowledge and agree that they are solely responsible for all legal, regulatory and safety-related requirements concerning their products and any use of Diodes Incorporated products in such safety-critical, life support devices or systems, notwithstanding any devices- or systems-related information or support that may be provided by Diodes Incorporated. Further, Customers must fully indemnify Diodes Incorporated and its representatives against any damages arising out of the use of Diodes Incorporated products in such safety-critical, life support devices or systems.

Copyright © 2020, Diodes Incorporated

www.diodes.com

单击下面可查看定价，库存，交付和生命周期等信息

[>>Diodes Incorporated\(达达科技\(美台\)\)](#)