

**100mA REGULATED CHARGE PUMP****AP3602A/B****General Description**

The AP3602A/B are regulated step-up DC/DC converters based on charge pump technique. These ICs have the ability to supply 100mA constant output current or 250mA peak output current for 100ms from 3.0V to 5V input (2.7V to 4.5 V for AP3602B), so they can be used as white LEDs driver or flash LED driver.

The AP3602A/B have very low power dissipation and high efficiency in typical applications. Other features include over-temperature protection, low temperature coefficient and etc. to meet some special requirements of hand-held battery powered devices.

Only 3 external capacitors are required in applications, which helps to save space and lower cost. These chips also have a disable terminal to turn on or turn off the chip to ease the use.

The AP3602A/B are available in SOT-23-6 package.

**Features**

- Low Quiescent Current: 13 $\mu$ A Typical
- Regulated Output Voltage Precision: 4%
- High Output Current:  
100mA when  $V_{IN} \geq 3.0V$   
50mA when  $V_{IN} \geq 2.7V$
- High Frequency: up to 1.2 MHz
- Low Shutdown Supply Current: <1 $\mu$ A
- High Output Peak Current: 250mA for 100ms
- Over Temperature Protection
- Operating Temperature Range: -40°C to 85°C

**Applications**

- Mobile Phone Backlight Driver
- Camera Flash LED Driver
- MP3, MP4
- Handheld Device
- Portable Communication Device

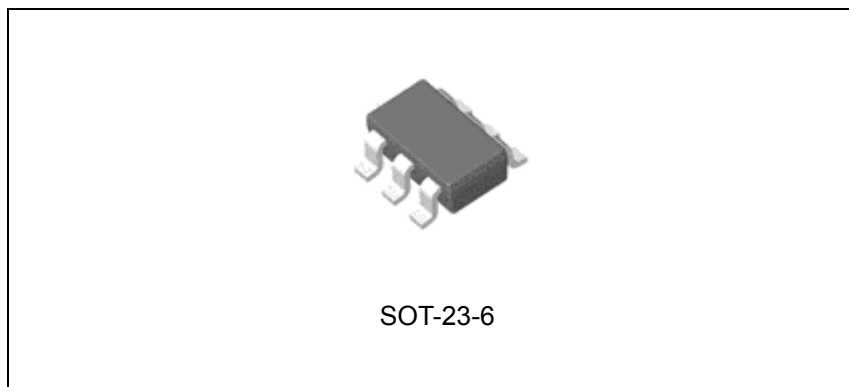

Figure 1. Package Type of AP3602A/B

**100mA REGULATED CHARGE PUMP**

**AP3602A/B**

**Pin Configuration**

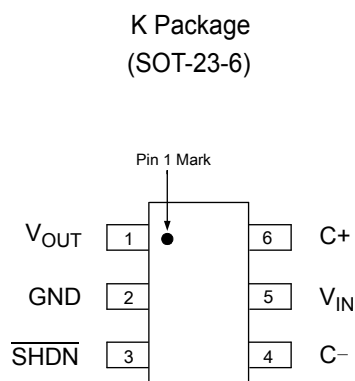

Figure 2. Pin Configuration of AP3602A/B (Top View)

**Pin Description**

Pin Number	Pin Name	Function
1	$V_{OUT}$	Regulated Output Voltage. $V_{OUT}$ should be bypassed with a 1 $\mu$ F to 22 $\mu$ F low ESR ceramic capacitor which is placed as close to the pin as possible for best performance
2	GND	Ground. GND should be tied to a ground plane for best performance. The $C_{OUT}$ and $C_{IN}$ should be placed as close to this pin as possible
3	$\overline{SHDN}$	Active Low Shutdown Input. A low signal on $\overline{SHDN}$ disables the AP3602A/B, while a high signal enables the AP3602A/B. $\overline{SHDN}$ pin must not be allowed to float
4	C-	Flying Capacitor Negative Terminal. The flying capacitor should be placed as close to this pin as possible
5	$V_{IN}$	Input Supply Voltage. $V_{IN}$ should be bypassed with a 1 $\mu$ F to 22 $\mu$ F low ESR ceramic capacitor which is placed as close to the pin as possible for best performance
6	C+	Flying Capacitor Positive Terminal. The flying capacitor should be placed as close to this pin as possible

**100mA REGULATED CHARGE PUMP**

**AP3602A/B**

**Functional Block Diagram**

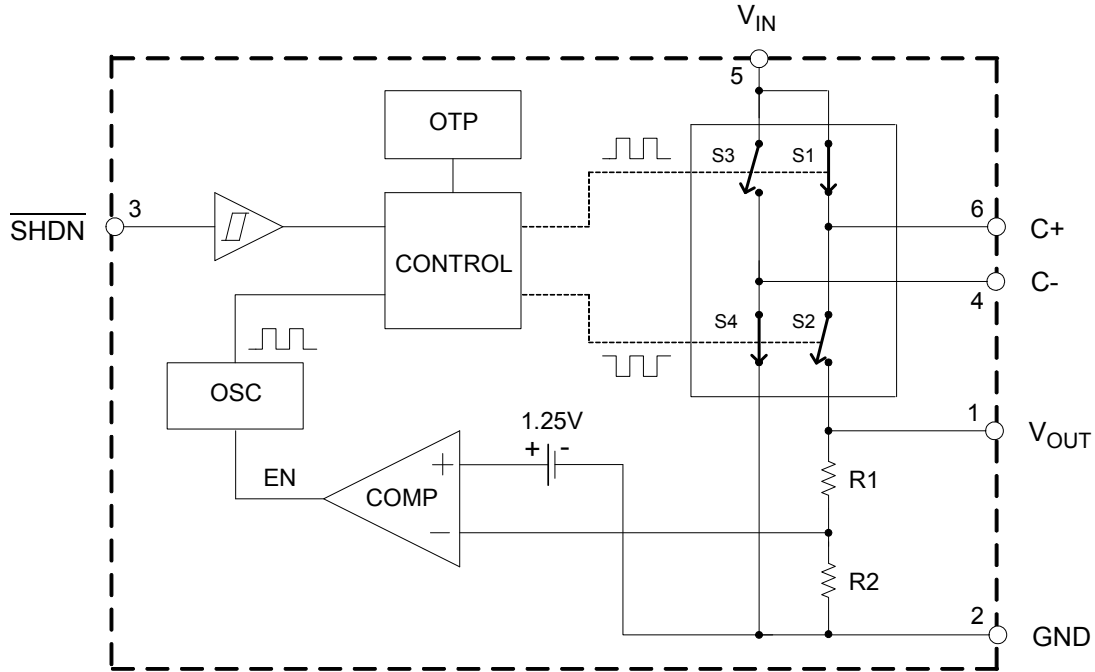
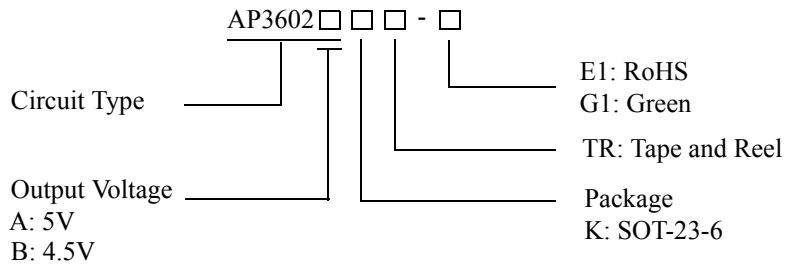

Figure 3. Functional Block Diagram of AP3602A/B

**Ordering Information**



Package	Temperature Range	Part Number		Marking ID		Packing Type
		RoHS	Green	RoHS	Green	
SOT-23-6	-40 to 85°C	AP3602AKTR-E1	AP3602AKTR-G1	E7T	G7T	Tape & Reel
		AP3602BKTR-E1	AP3602BKTR-G1	E8T	G8T	Tape & Reel

BCD Semiconductor's products as designated with "E1" suffix in the part number are RoHS compliant. Products with "G1" suffix are available in green packages.

**100mA REGULATED CHARGE PUMP****AP3602A/B****Absolute Maximum Ratings (Note 1)**

Parameter	Symbol	Value	Unit
Input Voltage	$V_{IN}$	7	V
Output Voltage	$V_O$	7	V
$\overline{\text{SHDN}}$ Pin Voltage	$V_{\overline{\text{SHDN}}}$	7	V
Thermal Resistance (Junction to Ambient, no Heat sink)	$R_{\theta JA}$	300	°C/W
Operating Junction Temperature	$T_J$	150	°C
Storage Temperature Range	$T_{STG}$	-65 to 150	°C
Lead Temperature (Soldering, 10sec)	$T_{LEAD}$	260	°C
ESD (Human Body Model)		2000	V

Note 1: Stresses greater than those listed under "Absolute Maximum Ratings" may cause permanent damage to the device. These are stress ratings only, and functional operation of the device at these or any other conditions beyond those indicated under "Recommended Operating Conditions" is not implied. Exposure to "Absolute Maximum Ratings" for extended periods may affect device reliability.

**Recommended Operating Conditions**

Parameter	Symbol	Min	Max	Unit	
Input Voltage	$V_{IN}$	AP3602A	2.7	5	V
		AP3602B	2.7	4.5	
Operating Temperature	$T_A$	-40	85	°C	



**100mA REGULATED CHARGE PUMP**

**AP3602A/B**

**Electrical Characteristics**

( $C_{FLY}=1\mu F$ ,  $C_{IN}=C_{OUT}=10\mu F$ ,  $T_A=25^\circ C$ , unless otherwise specified.)

**For AP3602A**

Parameter	Symbol	Conditions	Min	Typ	Max	Unit
Input Voltage	$V_{IN}$	$V_O=5V$	2.7		$V_O$	V
Quiescent Current	$I_Q$	$V_{IN}=2.7V$ to $5.0V$ , $I_O=0mA$ , $\overline{V_{SHDN}}=V_{IN}$ , Not Switching		13	30	$\mu A$
Output Voltage	$V_O$	$2.7V < V_{IN} < 5V$ , $I_O \leq 50mA$	4.8	5.0	5.2	V
		$3.0V < V_{IN} < 5V$ , $I_O \leq 100mA$	4.8	5.0	5.2	
Shutdown Supply Current	$\overline{I_{SHDN}}$	$2.7V < V_{IN} < 3.6V$ , $I_O=0$ , $\overline{V_{SHDN}}=0V$		0.01	1	$\mu A$
		$3.6V < V_{IN} < 5.0V$ , $I_O=0$ , $\overline{V_{SHDN}}=0V$			2.5	
Ripple Voltage	$V_{RIPPLE}$	$V_{IN}=2.7V$ , $I_O=50mA$		25		$mV_{PP}$
		$V_{IN}=3V$ , $I_O=100mA$		30		
Efficiency	$\eta$	$V_{IN}=2.7V$ , $I_O=50mA$		92		%
Frequency	$f_{OSC}$	Oscillator free running		1.2		MHz
SHDN Input Threshold High	$V_{IH}$		1.4			V
SHDN Input Threshold Low	$V_{IL}$				0.3	
SHDN Input Current High	$I_{IH}$	$\overline{V_{SHDN}}=V_{IN}$	-1		1	$\mu A$
SHDN Input Current Low	$I_{IL}$	$\overline{V_{SHDN}}=GND$	-1		1	
$V_{OUT}$ Turn-on Time	$t_{ON}$	$V_{IN}=3V$ , $I_O=0mA$		0.2		ms
Short-Circuit Current	$I_{SC}$	$V_{IN}=3V$ , $V_O=GND$ , $\overline{V_{SHDN}}=3V$		300		mA



**100mA REGULATED CHARGE PUMP**

**AP3602A/B**

**Electrical Characteristics (Continued)**

( $C_{FLY}=1\mu F$ ,  $C_{IN}=C_{OUT}=10\mu F$ ,  $T_A=25^\circ C$ , unless otherwise specified.)

**For AP3602B**

Parameter	Symbol	Conditions	Min	Typ	Max	Unit
Input Voltage	$V_{IN}$	$V_O=4.5V$	2.7		$V_O$	V
Quiescent Current	$I_Q$	$V_{IN}=2.7V$ to $4.5V$ , $I_O=0mA$ , $\overline{V_{SHDN}}=V_{IN}$ , Not Switching		13	30	$\mu A$
Output Voltage	$V_O$	$2.7V < V_{IN} < 4.5V$ , $I_O < 50mA$	4.32	4.5	4.68	V
		$3.0V < V_{IN} < 4.5V$ , $I_O < 100mA$	4.32	4.5	4.68	
Shutdown Supply Current	$\overline{I_{SHDN}}$	$2.7V < V_{IN} < 3.6V$ , $I_O=0$ , $\overline{V_{SHDN}}=0V$		0.01	1	$\mu A$
		$3.6V < V_{IN} < 4.5V$ , $I_O=0$ , $\overline{V_{SHDN}}=0V$			2.5	
Ripple Voltage	$V_{RIPPLE}$	$V_{IN}=2.7V$ , $I_O=50mA$		25		$mV_{PP}$
		$V_{IN}=3V$ , $I_O=100mA$		30		
Efficiency	$\eta$	$V_{IN}=2.7V$ , $I_O=50mA$		83		%
Frequency	$f_{OSC}$	Oscillator free running		1.2		MHz
SHDN Input Threshold High	$V_{IH}$		1.4			V
SHDN Input Threshold Low	$V_{IL}$				0.3	
SHDN Input Current High	$I_{IH}$	$\overline{V_{SHDN}}=V_{IN}$	-1		1	$\mu A$
SHDN Input Current Low	$I_{IL}$	$\overline{V_{SHDN}}=0V$	-1		1	
$V_{OUT}$ Turn-on Time	$t_{ON}$	$V_{IN}=3V$ , $I_O=0mA$		0.2		ms
Short-Circuit Current	$I_{SC}$	$V_{IN}=3V$ , $V_O=GND$ , $\overline{V_{SHDN}}=3V$		300		mA

**100mA REGULATED CHARGE PUMP****AP3602A/B****Application Information****Operating Principles**

The AP3602A/B use a switched capacitor charge pump to boost the input voltage to a regulated output voltage. Regulation is achieved by sensing the chip output voltage through an internal resistor divider network. Controlled by an internal comparator (refer to the functional block diagram), the charge pump circuit is enabled when the divided output voltage is below a preset trip point .

The charge pump operates at 1.2MHz with 50% duty cycle. Conversion consists of a two-phase operation. In the first phase, switches S2 and S3 are opened and S1 and S4 are closed. During this time,  $C_{FLY}$  charges to the voltage on  $V_{IN}$  and load current is supplied by  $C_{OUT}$ . During the second phase, S2 and S3 are closed, and S1 and S4 are opened. This action connects  $C_{FLY}$  low side to  $V_{IN}$ ,  $C_{FLY}$  high side to  $V_{OUT}$ , then a voltage about  $2*V_{IN}$  is used to charge  $C_{OUT}$  and supply the load current. For each cycle, charges is transported from  $V_{IN}$  to  $V_{OUT}$  to maintain the output voltage in its nominal value.

This process breaks when the  $V_{OUT}$  is high enough for the reason of higher input voltage or lower load, then the divided voltage at the control comparator exceeds the internal trip point high level, which compels the charge pump circuit enter to the idle mode in which the switching cycle stops (pulse skipping) and the output voltage is continually decreased because it is maintained by the discharging of  $C_{OUT}$  only. In idle mode, the feedback circuit continues sensing  $V_{OUT}$ . If the

divided voltage at the control comparator drops below the preset trip point, the comparator will start the switching cycle again.

In idle mode, the AP3602A/B's quiescent current is about  $13\mu A$ . In shutdown mode, all internal circuitry is turned off and the AP3602A/B draw only leakage current from  $V_{IN}$ , which is less than  $1\mu A$ . So, the shutdown power loss for AP3602A/B is very low, that is beneficial to the battery supplied systems.

**Short Circuit and Thermal Protection**

The AP3602A/B have a thermal protection and shutdown circuit that continuously monitors the IC junction temperature.

When output short circuit occurs, the short circuit current is about 300mA (Typical). Under this condition, the  $I_{IN}$  is about  $2*I_{out}$ , which causes about 1.8W instant power dissipation on AP3602A/B, that will cause a rise in the internal IC junction temperature. If the thermal protection circuit senses the junction temperature exceeding approximately  $160^{\circ}C$ , the thermal shutdown circuit will disable the charge pump switching circuit. The thermal hysteresis is about  $10^{\circ}C$ , which means that the charge pump circuit can be active when the short circuit is removed and the junction temperature drops below  $150^{\circ}C$ .

The thermal shutdown protection will cycle on and off if an output short circuit condition persists. This will allow the AP3602A/B to operate on a short circuit condition without latch up or damage to the device.



**100mA REGULATED CHARGE PUMP**

**AP3602A/B**

**Typical Performance Characteristics**

**Typical Performance Characteristics for AP3602A**

(Unless otherwise noted,  $V_{IN}=3.0V$ ,  $C_{IN}=C_{OUT}=10\mu F$ ,  $C_{FLY}=1\mu F$  Ceramic Cap,  $T_A=25^\circ C$ )

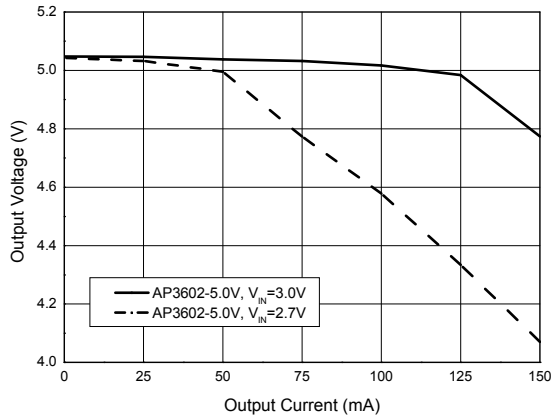

Figure 4. Output Voltage vs. Output Current

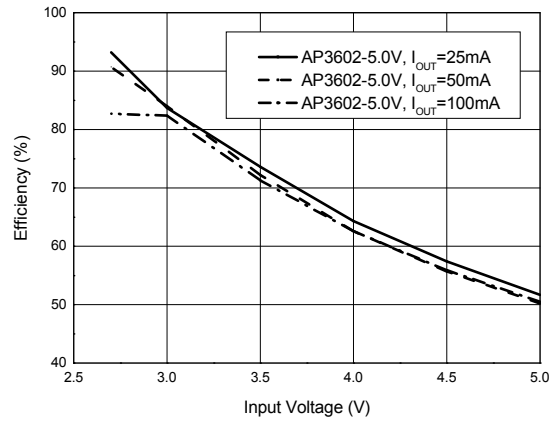

Figure 5. Efficiency vs. Input Voltage

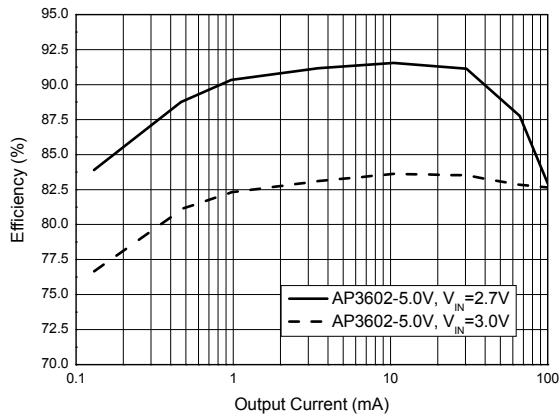

Figure 6. Efficiency vs. Output Current

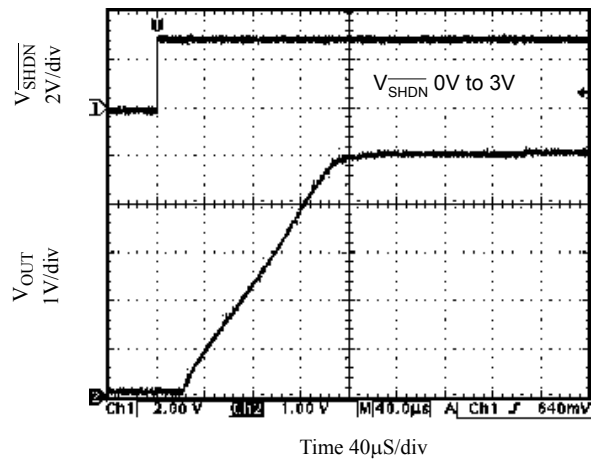

Figure 7.  $V_{OUT}$  Start UpTime, @ No Load



**100mA REGULATED CHARGE PUMP**

**AP3602A/B**

**Typical Performance Characteristics (Continued)**

**Typical Performance Characteristics for AP3602A (Continued)**

(Unless otherwise noted,  $V_{IN}=3.0V$ ,  $C_{IN}=C_{OUT}=10\mu F$ ,  $C_{FLY}=1\mu F$  Ceramic Cap,  $T_A=25^\circ C$ )

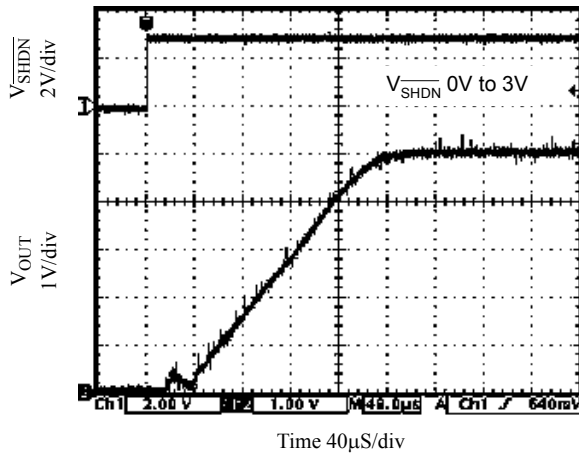

Figure 8.  $V_{OUT}$  Start Up Time, @ 50mA Load

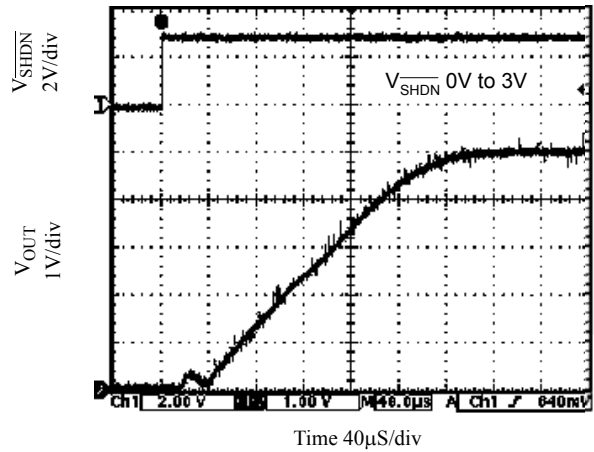

Figure 9.  $V_{OUT}$  Start Up Time, @ 100mA Load

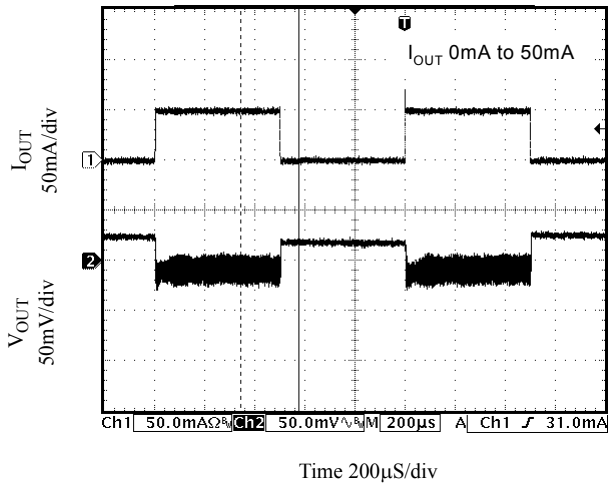

Figure 10. Load Transient Response

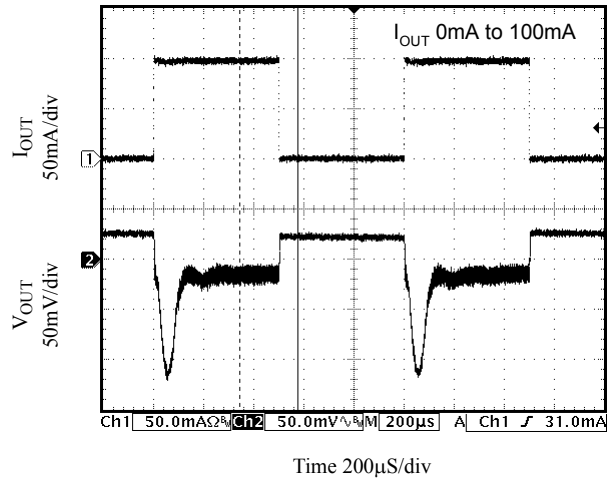

Figure 11. Load Transient Response

**100mA REGULATED CHARGE PUMP**

**AP3602A/B**

**Typical Performance Characteristics (Continued)**

**Typical Performance Characteristics for AP3602A (Continued)**

(Unless otherwise noted,  $V_{IN}=3.0V$ ,  $C_{IN}=C_{OUT}=10\mu F$ ,  $C_{FLY}=1\mu F$  Ceramic Cap,  $T_A=25^\circ C$ )

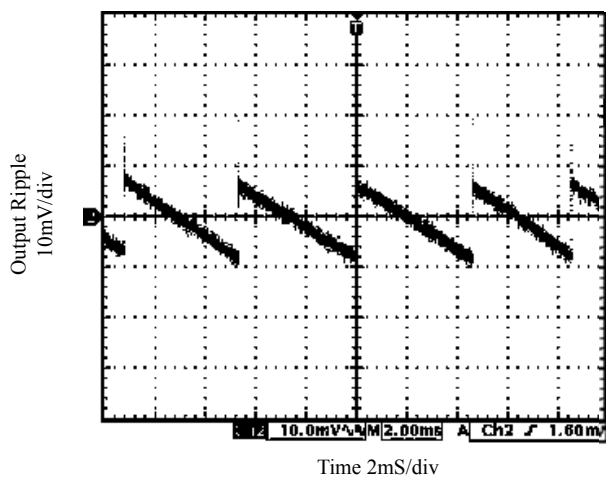

Figure 12. Output Ripple @  $V_{IN}=2.7V$ ,  $I_{OUT}=0mA$

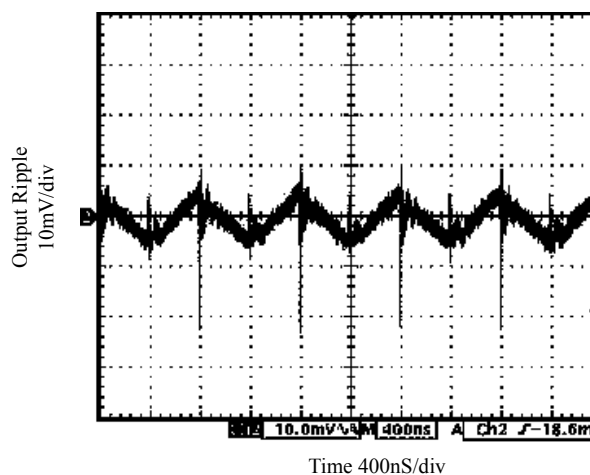

Figure 13. Output Ripple @  $V_{IN}=2.7V$ ,  $I_{OUT}=50mA$

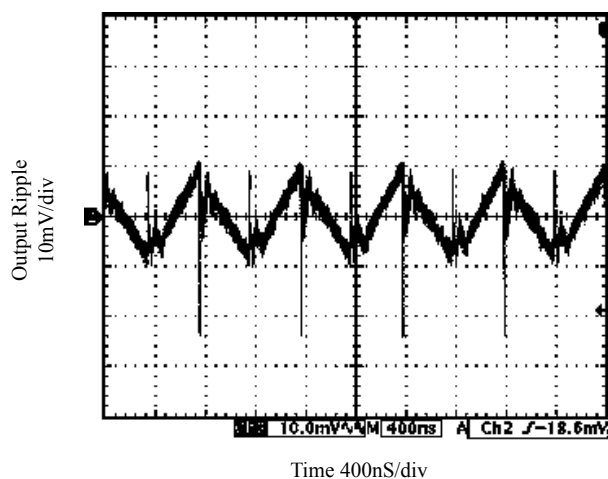

Figure 14. Output Ripple @  $V_{IN}=2.7V$ ,  $I_{OUT}=100mA$

**100mA REGULATED CHARGE PUMP**

**AP3602A/B**

**Typical Performance Characteristics (Continued)**

**Typical Performance Characteristics for AP3602B**

(Unless otherwise noted,  $V_{IN}=3.0V$ ,  $C_{IN}=C_{OUT}=10\mu F$ ,  $C_{FLY}=1\mu F$  Ceramic Cap,  $T_A=25^\circ C$ )

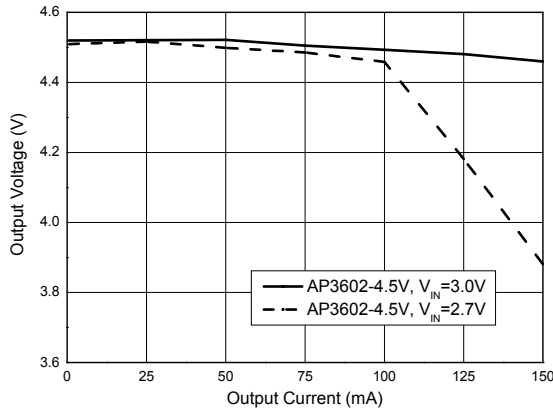

Figure 15. Output Voltage vs. Output Current

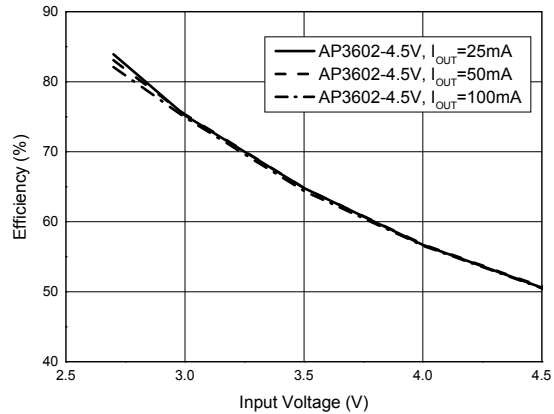

Figure 16. Efficiency vs. Input Voltage

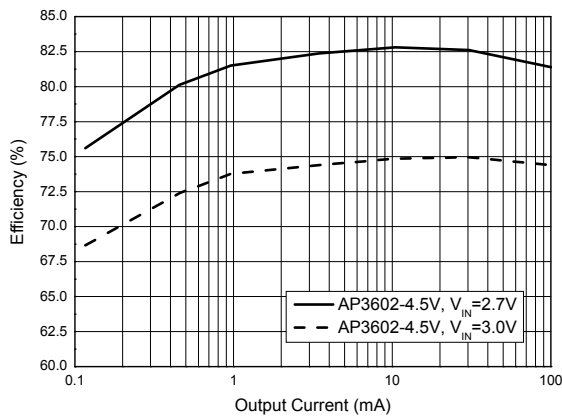

Figure 17. Efficiency vs. Output Current

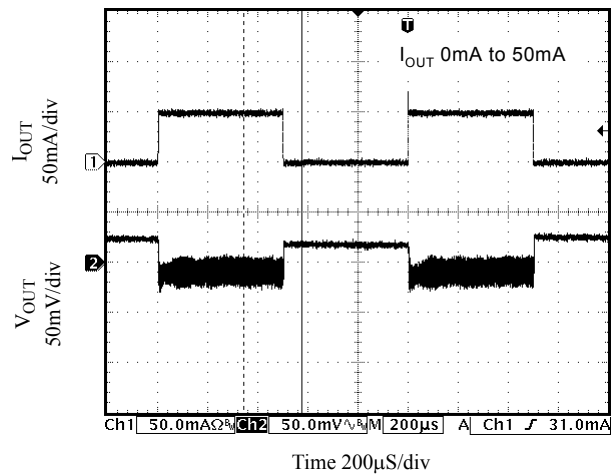

Figure 18. Load Transient Response

**100mA REGULATED CHARGE PUMP**

**AP3602A/B**

**Typical Performance Characteristics (Continued)**

**Typical Performance Characteristics for AP3602B (Continued)**

(Unless otherwise noted,  $V_{IN}=3.0V$ ,  $C_{IN}=C_{OUT}=10\mu F$ ,  $C_{FLY}=1\mu F$  Ceramic Cap,  $T_A=25^\circ C$ )

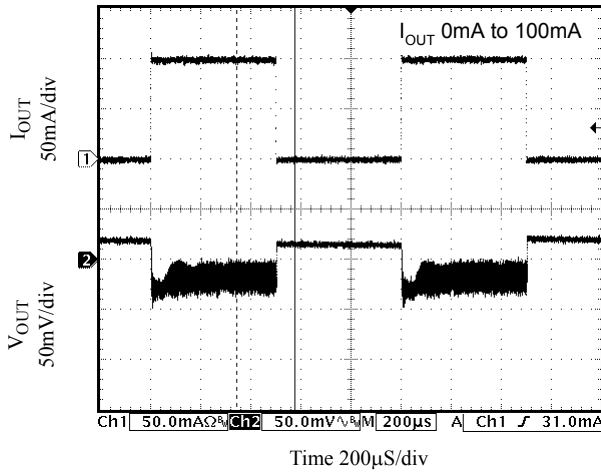

Figure 19. Load Transient Response

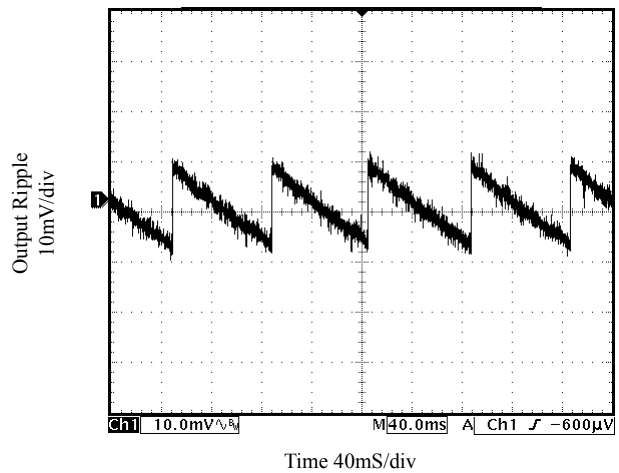

Figure 20. Output Ripple @  $V_{IN}=2.7V$ ,  $I_{OUT}=0mA$

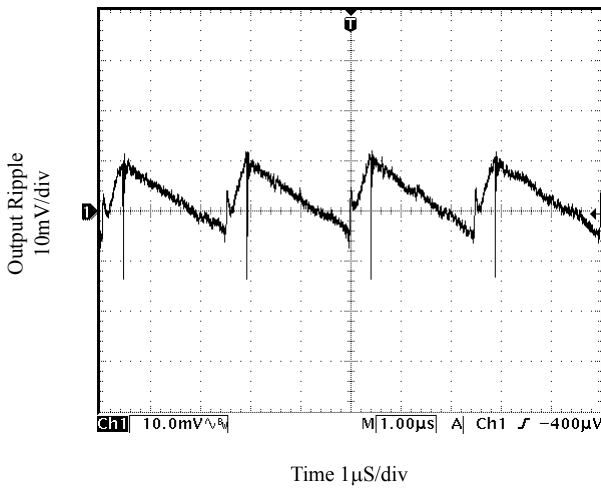

Figure 21. Output Ripple @  $V_{IN}=2.7V$ ,  $I_{OUT}=50mA$

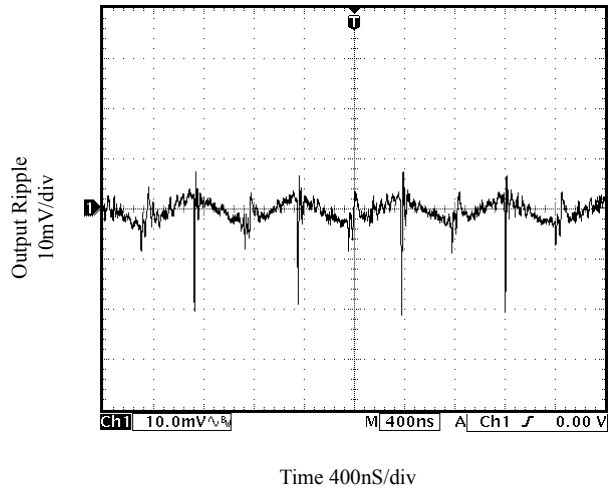

Figure 22. Output Ripple @  $V_{IN}=2.7V$ ,  $I_{OUT}=100mA$



**100mA REGULATED CHARGE PUMP**

**AP3602A/B**

**Typical Performance Characteristics (Continued)**

**Typical Performance Characteristics for AP3602A/B**

(Unless otherwise noted,  $V_{IN}=3.0V$ ,  $C_{IN}=C_{OUT}=10\mu F$ ,  $C_{FLY}=1\mu F$  Ceramic Cap,  $T_A=25^\circ C$ )

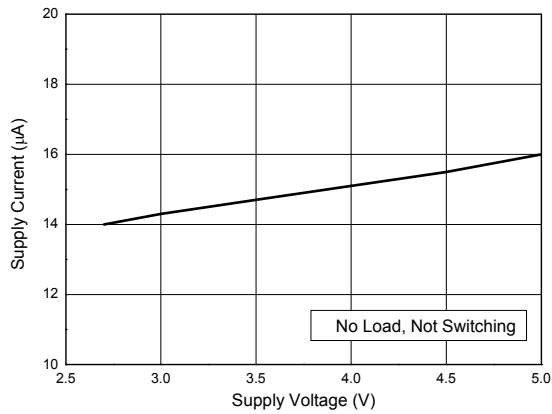

Figure 23. Supply Current vs. Supply Voltage

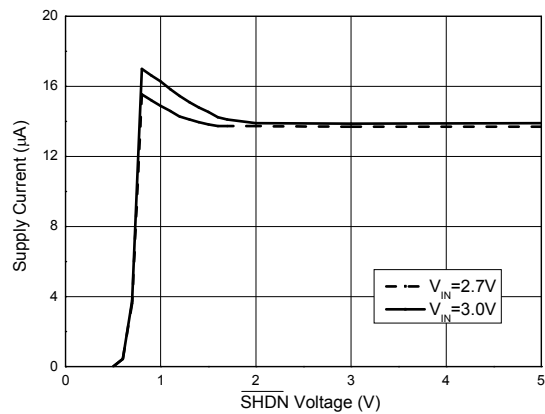

Figure 24. Supply Current vs. SHDN Voltage

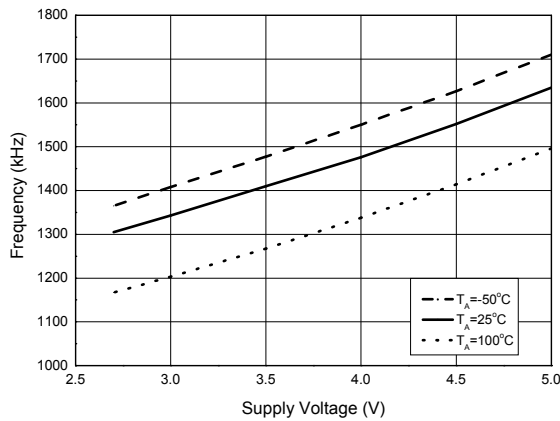

Figure 25. Oscillator Frequency vs. Supply Voltage

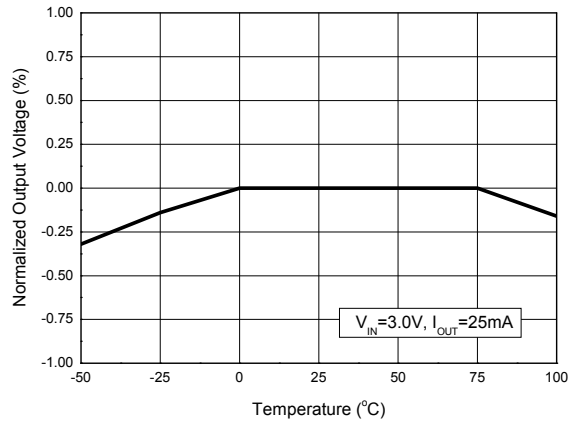

Figure 26. Normalized Output Voltage vs. Temperature



**100mA REGULATED CHARGE PUMP**

**AP3602A/B**

**Typical Performance Characteristics (Continued)**

**Typical Performance Characteristics for AP3602A/B (Continued)**

(Unless otherwise noted,  $V_{IN}=3.0V$ ,  $C_{IN}=C_{OUT}=10\mu F$ ,  $C_{FLY}=1\mu F$  Ceramic Cap,  $T_A=25^\circ C$ )

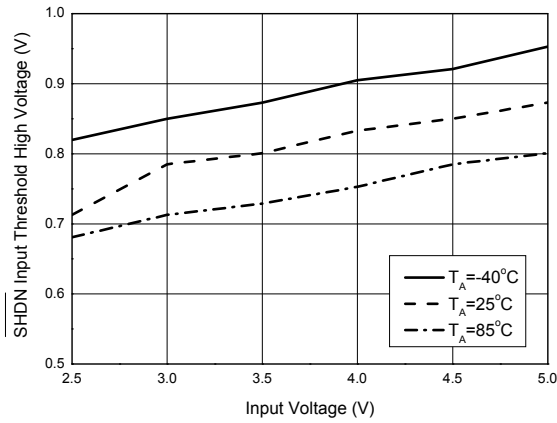

Figure 27.  $V_{IH}$  vs.  $V_{IN}$

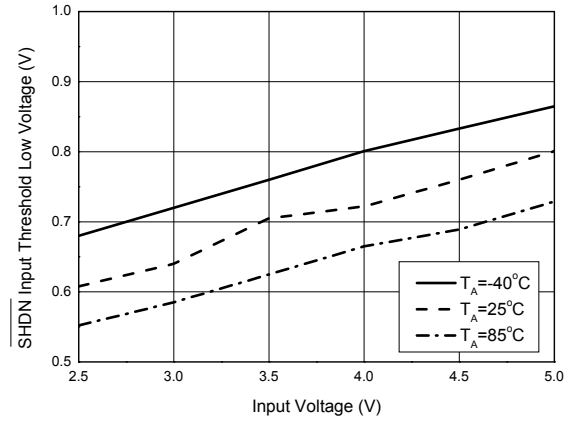

Figure 28.  $V_{IL}$  vs.  $V_{IN}$

**Typical Application**

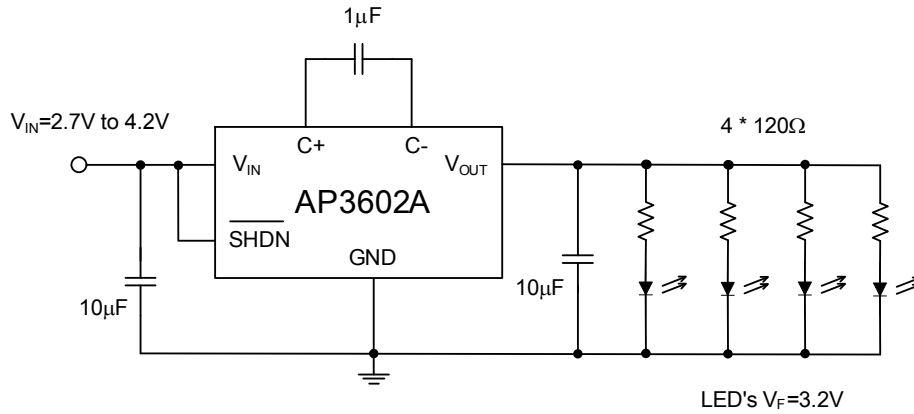

Figure 29. AP3602A Typical Application Circuit

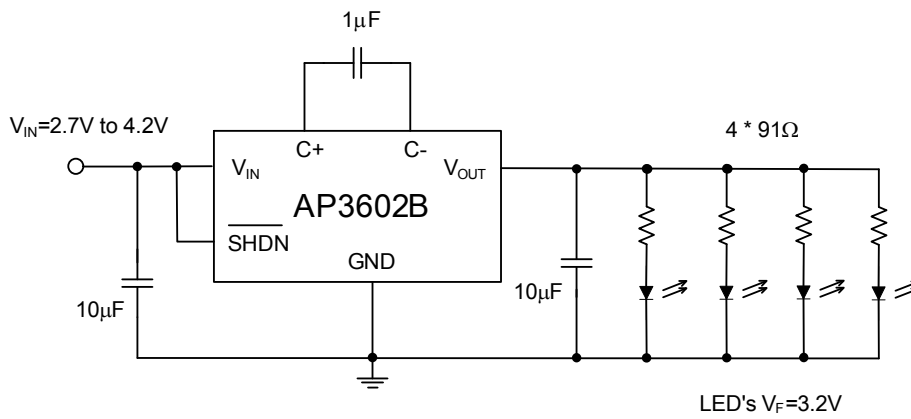

Figure 30. AP3602B Typical Application Circuit



100mA REGULATED CHARGE PUMP

AP3602A/B

Mechanical Dimensions

SOT-23-6

Unit: mm(inch)

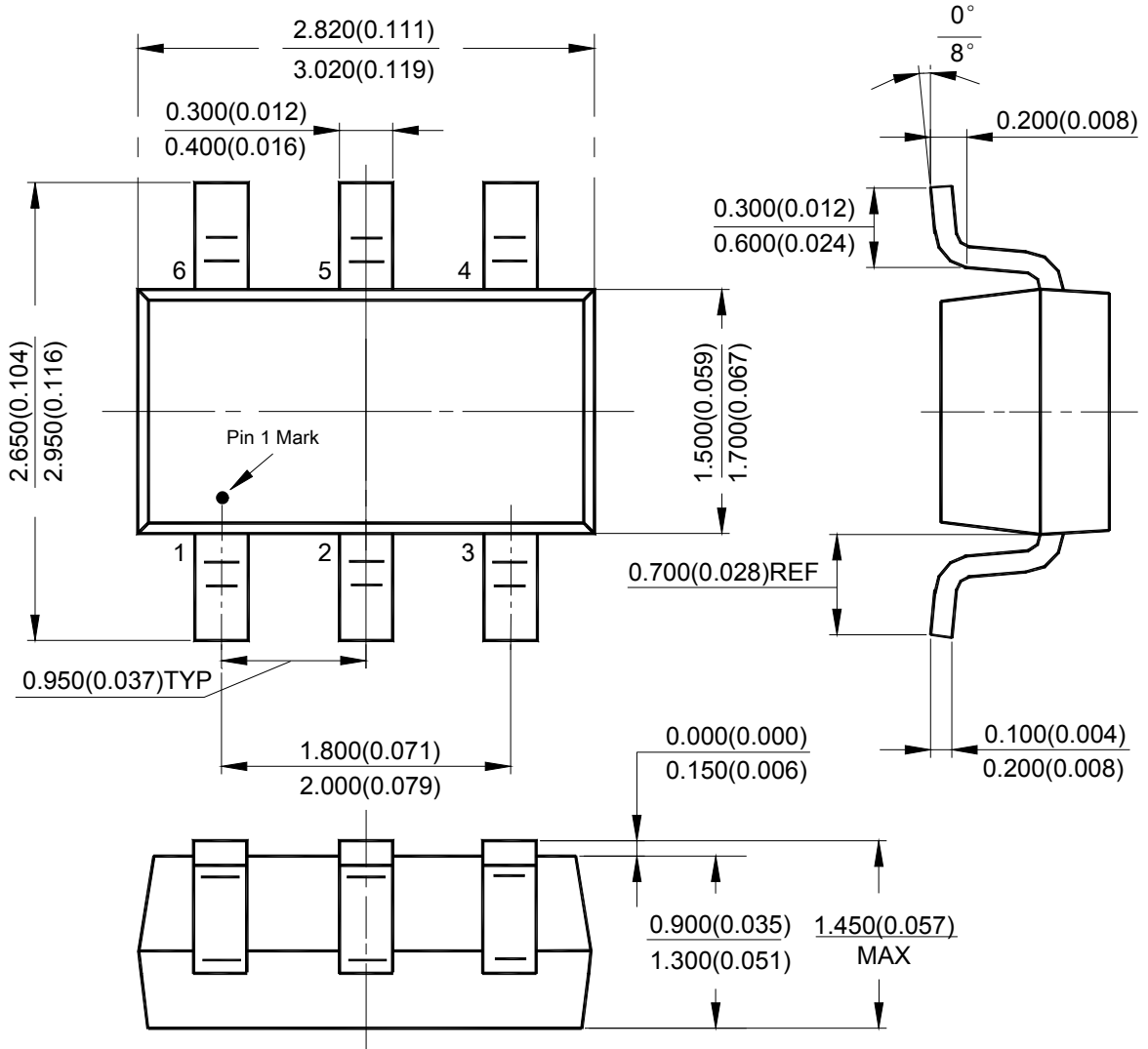





## BCD Semiconductor Manufacturing Limited

<http://www.bcdsemi.com>

### IMPORTANT NOTICE

BCD Semiconductor Manufacturing Limited reserves the right to make changes without further notice to any products or specifications herein. BCD Semiconductor Manufacturing Limited does not assume any responsibility for use of any its products for any particular purpose, nor does BCD Semiconductor Manufacturing Limited assume any liability arising out of the application or use of any its products or circuits. BCD Semiconductor Manufacturing Limited does not convey any license under its patent rights or other rights nor the rights of others.

---

#### MAIN SITE

##### - Headquarters

##### BCD Semiconductor Manufacturing Limited

No. 1600, Zi Xing Road, Shanghai Zizhu Science-based Industrial Park, 200241, China  
Tel: +86-21-24162266, Fax: +86-21-24162277

##### - Wafer Fab

##### Shanghai SIM-BCD Semiconductor Manufacturing Co., Ltd.

800 Yi Shan Road, Shanghai 200233, China  
Tel: +86-21-6485 1491, Fax: +86-21-5450 0008

#### REGIONAL SALES OFFICE

##### Shenzhen Office

##### Shanghai SIM-BCD Semiconductor Manufacturing Co., Ltd., Shenzhen Office

Unit A Room 1203, Skyworth Bldg., Gaoxin Ave. 1.S., Nanshan District, Shenzhen, China  
Tel: +86-755-8826 7951  
Fax: +86-755-8826 7865

##### Taiwan Office

##### BCD Semiconductor (Taiwan) Company Limited

4F, 298-1, Rui Guang Road, Nei-Hu District, Taipei, Taiwan  
Tel: +886-2-2656 2808  
Fax: +886-2-2656 2806

##### USA Office

##### BCD Semiconductor Corp.

30920 Huntwood Ave. Hayward, CA 94544, USA  
Tel : +1-510-324-2988  
Fax: +1-510-324-2788

单击下面可查看定价，库存，交付和生命周期等信息

[>>Diodes Incorporated\(达达科技\(美台\)\)](#)