

SPECIFICATION FOR APPROVAL

CUSTOMER	
NOMINAL FREQUENCY	25.000000 MHz
PRODUCT TYPE	TYPE FX 6.0x3.5 SEAM SEALED CRYSTAL
PART NUMBER	FX2500059
CUSTOMER P/N	
ISSUE DATE	March 22, 2018
VERSION	C

APPROVED	PREPARED	QA
Brenda Kuo	Claire Cheng	Dony Yang

Diodes Incorporated

No.2, Ziqiang 5th Rd., Zhongli Industrial Park,
Zhongli Dist., Taoyuan City 32063, Taiwan (R.O.C.)
TEL:886-3-451-8888
FAX:886-3-461-3865
<https://www.diodes.com>

*Pb-free

*RoHS Compliant

*HF-Halogen Free

*REACH Compliant

TYPE FX 6.0x3.5 SEAM SEALED CRYSTAL

FX2500059

VER.C 22-MAR-18

ELECTRICAL SPECIFICATIONS

Item	Symbol	Specifications	Units	Notes
Nominal Frequency	Fn	25.000000	MHz	
Mode of Oscillation	MO	AT Cut-Fundamental		
Calibration Load Capacitance	CL	18	pF	
Calibration Tolerance	FL	± 20	ppm	at 25°C±3°C
Operating Temperature Range	TR	-40 to +85	°C	
Frequency Stability(Frequency Deviation over the Operating Temperature Range)	F/T	± 20	ppm	Reference to the Frequency at 25°C
Operating Drive Level		10	μW	
Maximum Drive Level		500	μW	
Equivalent Series Resistance	ESR	50	Ω	Max.
Shunt Capacitance	C0	5	pF	Max.
Aging at 25°C		± 5	ppm	Max, 1st year
Storage Temperature		-55 to +125	°C	
Insulation Resistance		500	MΩ	Min

** This product doesn't include harmful substance that stipulated by SONY SS-00259 Level 1 and S-AT2-001 Level 1 standard. RoHS Compliant (Pb - Free).

TYPE FX 6.0x3.5 SEAM SEALED CRYSTAL

FX2500059

VER.C 22-MAR-18

RELIABILITY SPECIFICATIONS

MECHANICAL AND ENVIRONMENTAL RATINGS:

- a) FINE LEAK TEST: JESD22-A109 (Condition 1A)
- b) GROSS LEAK TEST: JESD22-A109 (Condition C)
- c) MOISTURE RESISTANCE: JESD22-A113
- d) SHOCK: JESD22-B104 (Condition B)
- e) SOLDERABILITY : (RoHS version): J-STD-002
- f) VIBRATION: JESD22-B103
- g) SOLVENT RESISTANCE: JESD22-B107
- h) RESISTANCE TO SOLDERING HEAT (RoHS version): J-STD-020D Table 5.2 Pb free devices (3 cycles max)

SUGGESTED IR REFLOW PROFILE

*As per IPC-JEDEC J-STD-020D

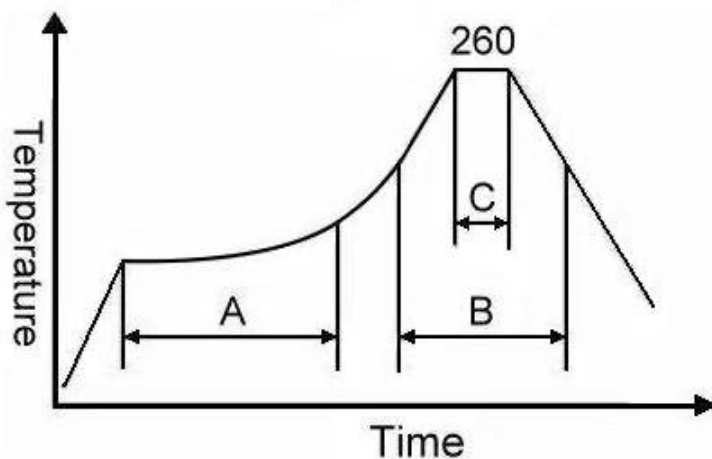

Note:

	Stage	Temperature	Time
A	Preheat	150~200°C	60~120 Sec
B	Primary Heat	217°C	60~150 Sec
C	Peak	260°C	10 Sec

TYPE FX 6.0x3.5 SEAM SEALED CRYSTAL

FX2500059

VER.C 22-MAR-18

MARKING

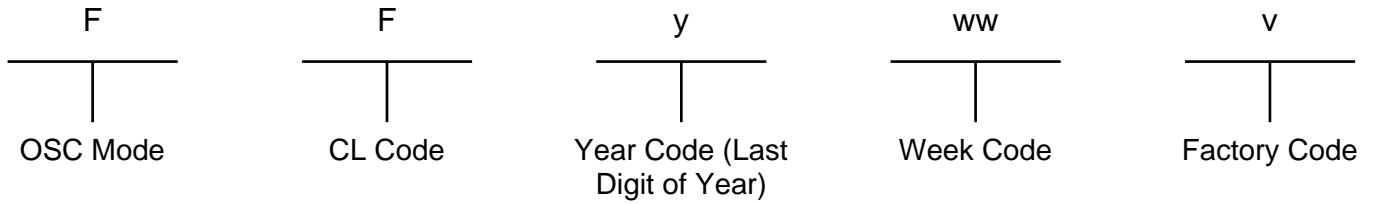
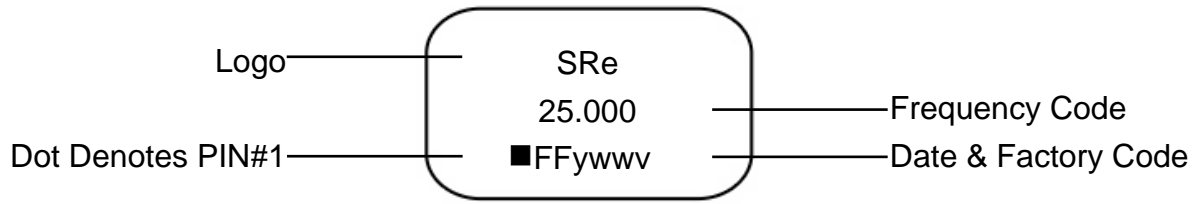

MECHANICAL DRAWINGS (Scale: None. Dimensions are in mm.)

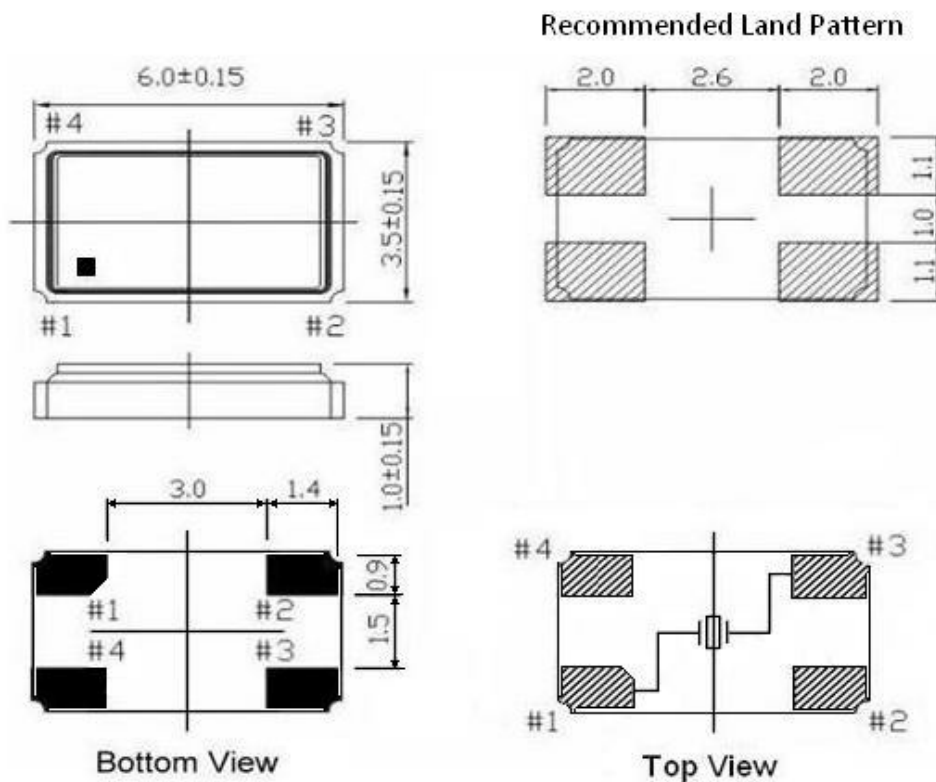

** Recommended - Pin 1 & 3 : CRYSTAL
Pin 2 & 4 : GND

Notes:

1. Package drawings are for reference only, and the appearances of objects may vary. Actual packages are based on the real product.
2. The marking dot denotes Pin#1.
3. The position and shape of the chamfer pin may vary and are based on the real product.

TYPE FX 6.0x3.5 SEAM SEALED CRYSTAL

FX2500059

VER.C 22-MAR-18

Tape & Reel

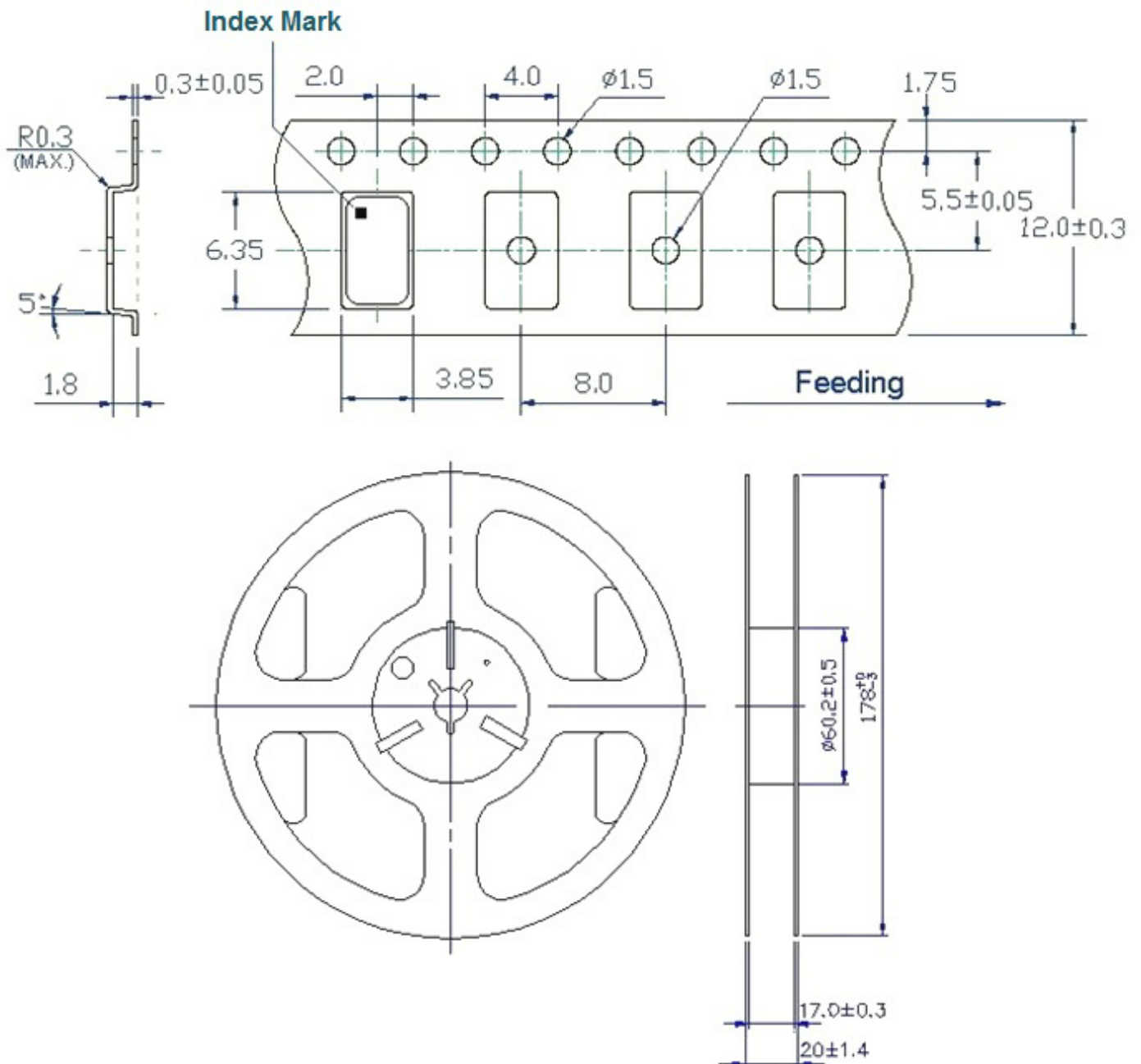

1. 230mm minimum leader which consist of carrier and/or tape followed by a minimum of 160mm of empty carrier tape sealed with cover tape.
2. 160mm minimum trailer of empty carrier tape sealed with cover tape.

TYPE FX 6.0x3.5 SEAM SEALED CRYSTAL

FX2500059

VER.C 22-MAR-18

PACKING

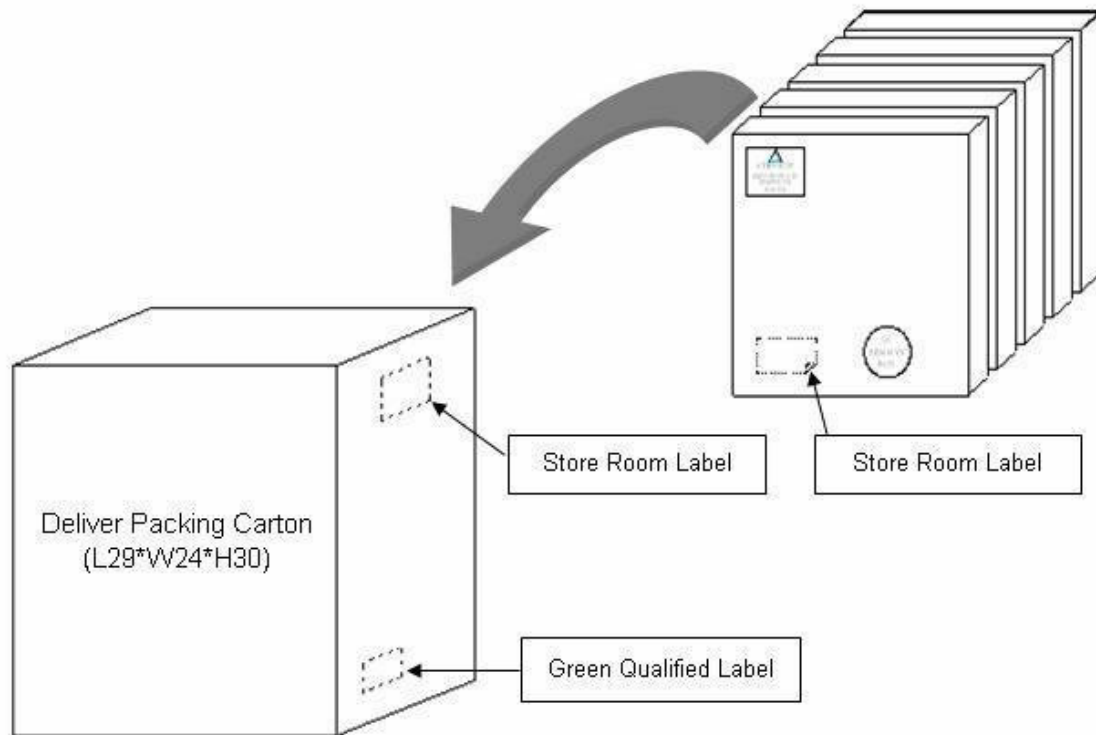
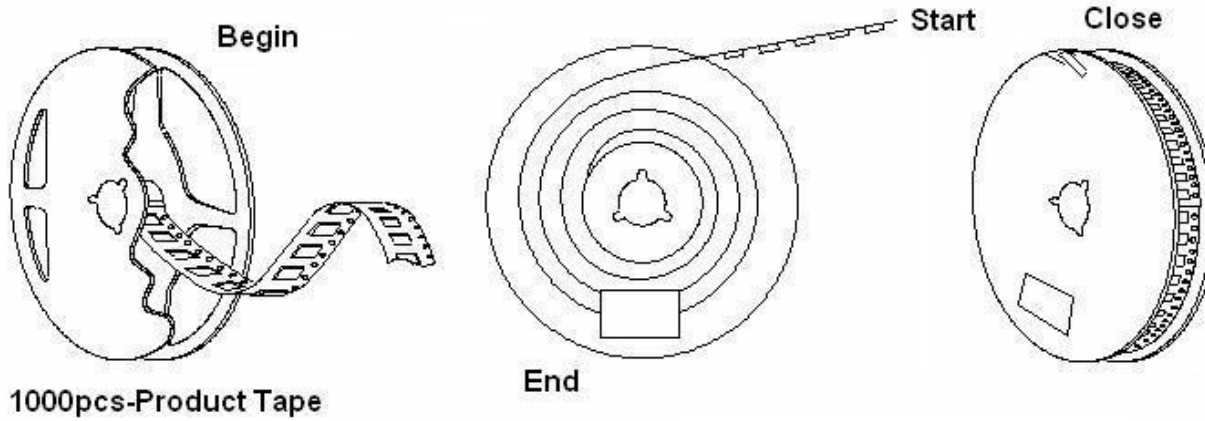

TYPE FX 6.0x3.5 SEAM SEALED CRYSTAL

FX2500059

VER.C 22-MAR-18

VERSION HISTORY

Version No.	Version Date	Description	Notes
C	Mar. 22, 2018	Updated logo	

单击下面可查看定价，库存，交付和生命周期等信息

[>>Diodes Incorporated\(达达科技\(美台\)\)](#)