

**4 CHANNEL LOW CAPACITANCE TVS DIODE ARRAY**

**Features**

- Low Clamping Voltage
- Typical 9V at 10A 100ns, TLP
- Typical 9V at 10A 8μs/20μs
- IEC 61000-4-2 (ESD): Air – ±30kV, Contact – ±30kV
- IEC 61000-4-4 (EFT): 60A(5/50ns, I/O to V<sub>SS</sub>)
- IEC 61000-4-5 (Lightning): ±10A
- 4 Channels of ESD protection
- Low Channel Input Capacitance of 1.2pF Typical
- TLP Dynamic Resistance: 0.25Ω
- Typically Used for High Speed Ports such as USB 2.0, IEEE1394, VGA, Laptop and Personal Computers, Flat Panel Displays, Video Graphics Displays, SIM Ports
- Totally Lead-Free & Fully RoHS Compliant (Notes 1 & 2)
- Halogen and Antimony Free. "Green" Device (Note 3)

**Mechanical Data**

- Case: SOT26
- Case Material: Molded Plastic, "Green" Molding Compound.
- UL Flammability Classification Rating 94V-0
- Moisture Sensitivity: Level 1 per J-STD-020
- Terminals: Matte Tin Finish annealed over Copper leadframe (Lead Free Plating). Solderable per MIL-STD-202, Method 208③
- Weight: 0.016 grams (approximate)

SOT26



Top View

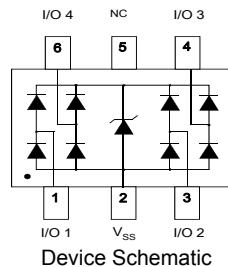

**Ordering Information** (Note 4)

Product	Compliance	Marking	Reel Size (inches)	Tape Width (mm)	Quantity per Reel
DT2042-04SO-7	Standard	BC5	7	8	3,000/Tape & Reel

- Notes:
1. No purposely added lead. Fully EU Directive 2002/95/EC (RoHS) & 2011/65/EU (RoHS 2) compliant.
  2. See [http://www.diodes.com/quality/lead\\_free.html](http://www.diodes.com/quality/lead_free.html) for more information about Diodes Incorporated's definitions of Halogen- and Antimony-free, "Green" and Lead-free.
  3. Halogen- and Antimony-free "Green" products are defined as those which contain <900ppm bromine, <900ppm chlorine (<1500ppm total Br + Cl) and <1000ppm antimony compounds.
  4. For packaging details, go to our website at <http://www.diodes.com/products/packages.html>.

**Marking Information**

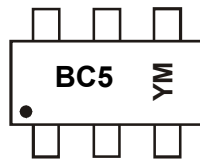

BC5 = Product Type Marking Code  
 YM = Date Code Marking  
 Y = Year (ex: A = 2013)  
 M = Month (ex: 9 = September)

Date Code Key

Year	2013	2014	2015	2016	2017	2018
Code	A	B	C	D	E	F

Month	Jan	Feb	Mar	Apr	May	Jun	Jul	Aug	Sep	Oct	Nov	Dec
Code	1	2	3	4	5	6	7	8	9	O	N	D

**Maximum Ratings** (@T<sub>A</sub> = +25°C, unless otherwise specified.)

Characteristic	Symbol	Value	Unit	Conditions
Peak Pulse Current, per IEC 61000-4-5	I <sub>PP</sub>	±10	A	I/O to V <sub>SS</sub> , 8/20 μs
Peak Pulse Power, per IEC 61000-4-5	P <sub>PP</sub>	105	W	I/O to V <sub>SS</sub> , 8/20 μs
Operating Voltage (DC)	V <sub>DC</sub>	5.5	V	I/O to V <sub>SS</sub>
ESD Protection – Contact Discharge, per IEC61000-4-2	V <sub>ESD_contact</sub>	±30	kV	I/O to V <sub>SS</sub>
ESD Protection – Air Discharge, per IEC 61000-4-2	V <sub>ESD_air</sub>	±30	kV	I/O to V <sub>SS</sub>
Operating Temperature	T <sub>OP</sub>	-55 to +85	°C	—
Storage Temperature	T <sub>STG</sub>	-55 to +150	°C	—

**Thermal Characteristics**

Characteristic	Symbol	Value	Unit
Power Dissipation Typical (Note 5)	P <sub>D</sub>	300	mW
Thermal Resistance, Junction to Ambient Typical (Note 5)	R <sub>θJA</sub>	417	°C/W

**Electrical Characteristics** (@T<sub>A</sub> = +25°C, unless otherwise specified.)

Characteristic	Symbol	Min	Typ	Max	Unit	Test Conditions
Reverse Working Voltage	V <sub>RWM</sub>	—	—	5.5	V	I/O to V <sub>SS</sub>
Reverse Current(Note6)	I <sub>R</sub>	—	—	1	μA	V <sub>R</sub> = 5V, any I/O to V <sub>SS</sub>
Reverse Breakdown Voltage	V <sub>BR</sub>	6	—	9	V	I <sub>R</sub> = 1mA, I/O to V <sub>SS</sub>
Forward Clamping Voltage	V <sub>F</sub>	-1.0	-0.8	—	V	I <sub>F</sub> = -15mA, I/O to V <sub>SS</sub>
Holding Voltage	V <sub>H</sub>	5.5	—	—	V	—
Trigger Voltage	V <sub>TRIG</sub>	—	9	9.5	V	—
Reverse Clamping Voltage (Note 7)	V <sub>C_5A</sub>	—	7.5	—	V	I <sub>PP</sub> = 5A, I/O to V <sub>SS</sub> , 8/20 μs
Reverse Clamping Voltage (Note 7)	V <sub>C_10A</sub>	—	9	10.5	V	I <sub>PP</sub> = 10A, I/O to V <sub>SS</sub> , 8/20 μs
ESD Clamping Voltage	V <sub>ESD</sub>	—	9	—	V	TLP, 10A, tp = 100 ns, I/O to V <sub>SS</sub> , per Fig. 7
Dynamic Resistance	R <sub>DIF</sub>	—	0.25	—	Ω	TLP, 10A, tp = 100 ns, I/O to V <sub>SS</sub>
Channel Input Capacitance	C <sub>I/O</sub>	—	1.2	1.5	pF	V <sub>R</sub> = 2.5V, f = 1MHz
Variation of Channel Input Capacitance	ΔC <sub>I/O</sub>	—	0.02	—	pF	V <sub>SS</sub> = 0V, I/O = 2.5V, f = 1MHz, T = 25°C, I/O_x to V <sub>SS</sub> – I/O_y to V <sub>SS</sub>

- Notes:
- Device mounted on FR-4 PCB pad layout (2oz copper) as shown on Diodes, Inc. suggested pad layout AP02001, which can be found on our website at <http://www.diodes.com>.
  - Short duration pulse test used to minimize self-heating effect.
  - Clamping voltage value is based on an 8x20μs peak pulse current (I<sub>pp</sub>) waveform.

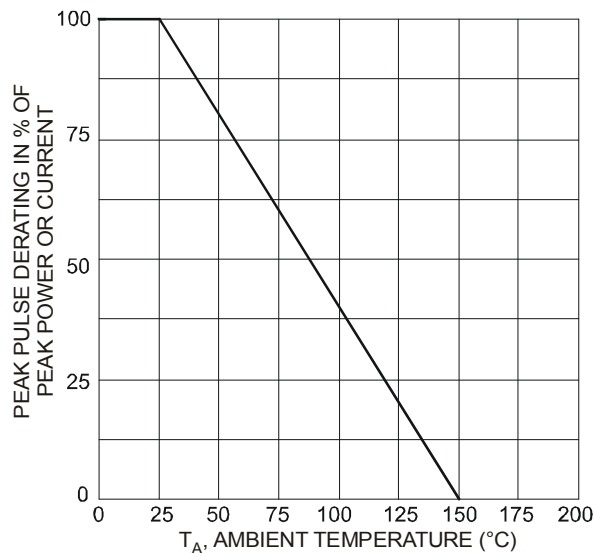

Figure 1 Pulse Derating Curve

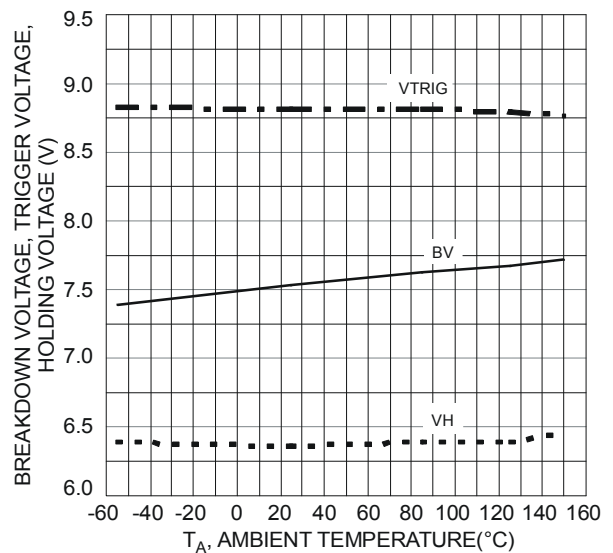

Figure 2 BV, Trigger Voltage, Holding Voltage vs. Ambient Temperature

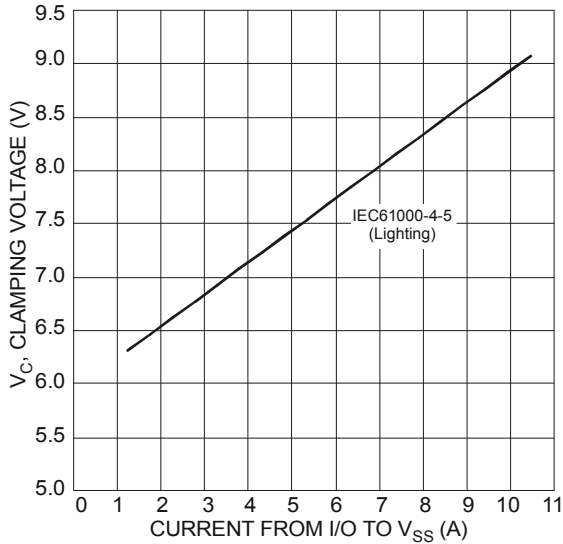

Figure 3 Clamping Voltage Characteristic

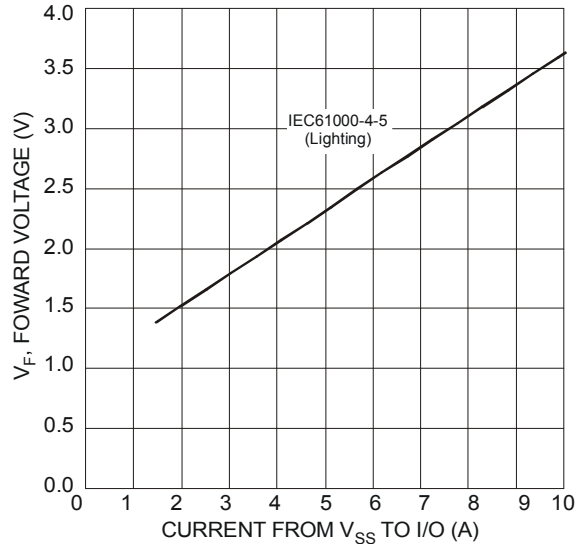

Figure 4 Forward Voltage Characteristic

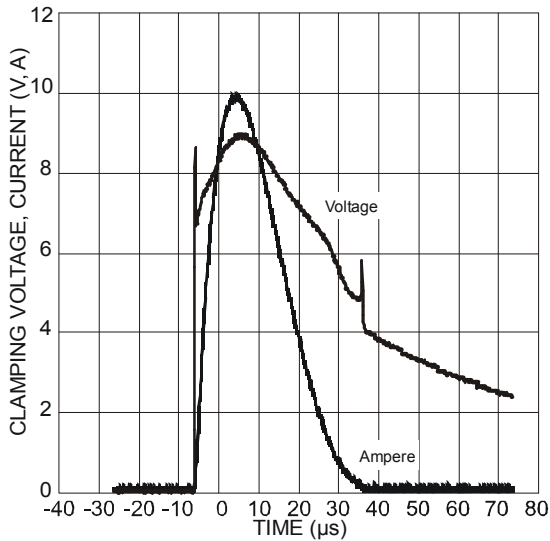

Figure 5 Waveform of Clamping Voltage, Current vs. Time (8/20µs, I/O to V<sub>SS</sub>)

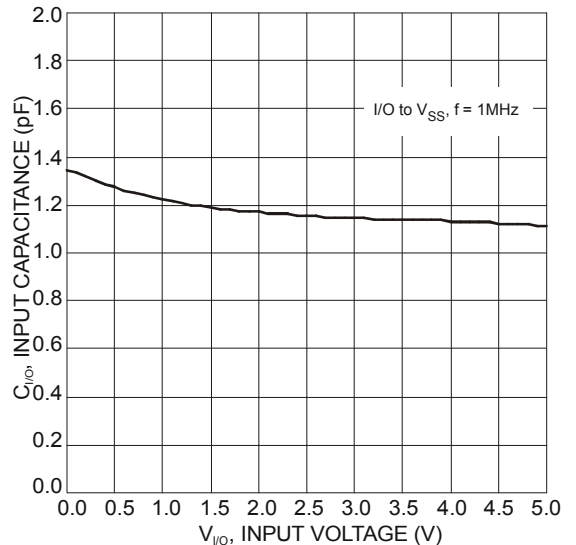

Figure 6 Input Capacitance vs. Input Voltage

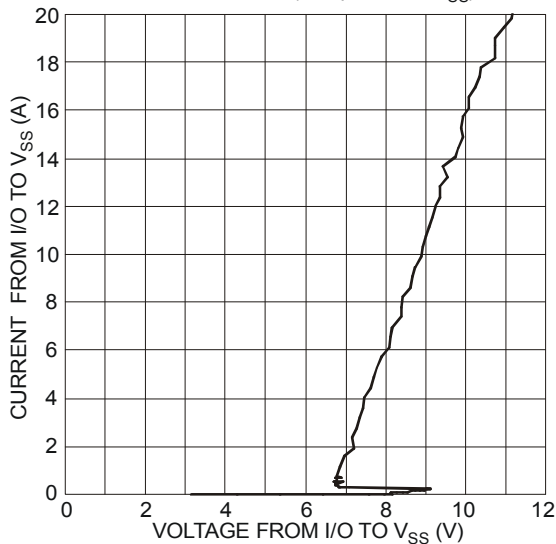
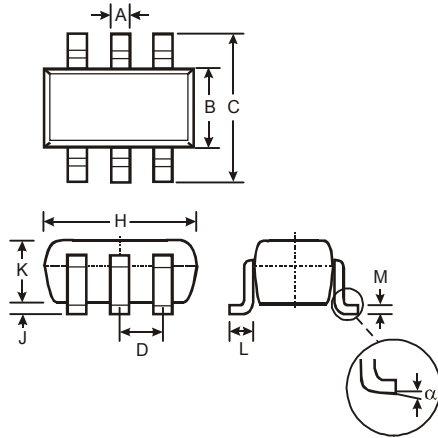

Figure 7 Current vs. Voltage

**Package Outline Dimensions**

Please see AP02002 at <http://www.diodes.com/datasheets/ap02002.pdf> for latest version.



SOT26			
Dim	Min	Max	Typ
A	0.35	0.50	0.38
B	1.50	1.70	1.60
C	2.70	3.00	2.80
D	—	—	0.95
H	2.90	3.10	3.00
J	0.013	0.10	0.05
K	1.00	1.30	1.10
L	0.35	0.55	0.40
M	0.10	0.20	0.15
α	0°	8°	—
<b>All Dimensions in mm</b>			

**Suggested Pad Layout**

Please see AP02001 at <http://www.diodes.com/datasheets/ap02001.pdf> for the latest version.

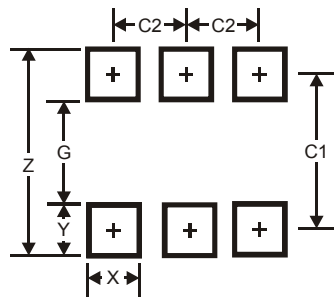

Dimensions	Value (in mm)
Z	3.20
G	1.60
X	0.55
Y	0.80
C1	2.40
C2	0.95

**IMPORTANT NOTICE**

DIODES INCORPORATED MAKES NO WARRANTY OF ANY KIND, EXPRESS OR IMPLIED, WITH REGARDS TO THIS DOCUMENT, INCLUDING, BUT NOT LIMITED TO, THE IMPLIED WARRANTIES OF MERCHANTABILITY AND FITNESS FOR A PARTICULAR PURPOSE (AND THEIR EQUIVALENTS UNDER THE LAWS OF ANY JURISDICTION).

Diodes Incorporated and its subsidiaries reserve the right to make modifications, enhancements, improvements, corrections or other changes without further notice to this document and any product described herein. Diodes Incorporated does not assume any liability arising out of the application or use of this document or any product described herein; neither does Diodes Incorporated convey any license under its patent or trademark rights, nor the rights of others. Any Customer or user of this document or products described herein in such applications shall assume all risks of such use and will agree to hold Diodes Incorporated and all the companies whose products are represented on Diodes Incorporated website, harmless against all damages.

Diodes Incorporated does not warrant or accept any liability whatsoever in respect of any products purchased through unauthorized sales channel. Should Customers purchase or use Diodes Incorporated products for any unintended or unauthorized application, Customers shall indemnify and hold Diodes Incorporated and its representatives harmless against all claims, damages, expenses, and attorney fees arising out of, directly or indirectly, any claim of personal injury or death associated with such unintended or unauthorized application.

Products described herein may be covered by one or more United States, international or foreign patents pending. Product names and markings noted herein may also be covered by one or more United States, international or foreign trademarks.

This document is written in English but may be translated into multiple languages for reference. Only the English version of this document is the final and determinative format released by Diodes Incorporated.

**LIFE SUPPORT**

Diodes Incorporated products are specifically not authorized for use as critical components in life support devices or systems without the express written approval of the Chief Executive Officer of Diodes Incorporated. As used herein:

A. Life support devices or systems are devices or systems which:

1. are intended to implant into the body, or
2. support or sustain life and whose failure to perform when properly used in accordance with instructions for use provided in the labeling can be reasonably expected to result in significant injury to the user.

B. A critical component is any component in a life support device or system whose failure to perform can be reasonably expected to cause the failure of the life support device or to affect its safety or effectiveness.

Customers represent that they have all necessary expertise in the safety and regulatory ramifications of their life support devices or systems, and acknowledge and agree that they are solely responsible for all legal, regulatory and safety-related requirements concerning their products and any use of Diodes Incorporated products in such safety-critical, life support devices or systems, notwithstanding any devices- or systems-related information or support that may be provided by Diodes Incorporated. Further, Customers must fully indemnify Diodes Incorporated and its representatives against any damages arising out of the use of Diodes Incorporated products in such safety-critical, life support devices or systems.

Copyright © 2013, Diodes Incorporated

[www.diodes.com](http://www.diodes.com)

单击下面可查看定价，库存，交付和生命周期等信息

[>>Diodes Incorporated\(达达科技\(美台\)\)](#)