

Description

The AP22908 slew rate controlled load switch is a single P-channel MOSFET power switch designed for high-side load-switching applications. The MOSFET has a typical low $R_{DS(ON)}$ of 28mΩ at 3.6V, allowing increased load current handling capacity with a low forward voltage drop. The turn-on slew rate of the device is controlled internally to avoid inrush current.

The AP22908 load switch is designed to operate from 1.08V to 3.6V, making it ideal for 1.2V, 1.8V, 2.5V, 3.3V and 3.6V systems. The typical quiescent supply current is only 0.05μA.

The AP22908 is available in the wafer level chip scale 4-pin, X1-WLB0909-4 0.5mm pitch, U-WLB0909-4 0.5mm pitch and standard SOT26 packages.

Features

- Wide Input Voltage Range: 1.08V to 3.6V
- Low On-Resistance:
 - 69mΩ Typical @1.2V
 - 41mΩ Typical @1.8V
 - 33mΩ Typical @2.5V
 - 28mΩ Typical @3.6V
- High DC Current Capability up to 1.5A
- Quick Discharging by Output Discharge Resistance
- Ultra Low Quiescent Current 0.05μA
- Active-High Control Pin
 - Minimum 0.9V V_{IH} of ON
- ESD Protection:
 - Human Body Model: 2kV
 - Charged Device Model: 1kV
- Package:
 - X1-WLB0909-4 with Backside Laminate
 - U-WLB0909-4 with Backside Laminate
 - 0.87mm × 0.87mm, 0.5mm Ball Pitch
 - Standard Green SOT26
- Moisture Sensitivity: Level 1 per J-STD-020
- Terminals: Finish – Matte Tin Plated Leads, Solderable per MIL-STD-202, Method 208 (e3)
- Weight: 0.001 grams (Approximate)
- **Lead-Free Finish; RoHS Compliant (Notes 1 & 2)**
- **Halogen- and Antimony- Free. "Green" Device (Note 3)**

- Notes:
1. EU Directive 2002/95/EC (RoHS), 2011/65/EU (RoHS 2) & 2015/863/EU (RoHS 3) compliant. All applicable RoHS exemptions applied.
 2. See <https://www.diodes.com/quality/lead-free/> for more information about Diodes Incorporated's definitions of Halogen- and Antimony-free, "Green" and Lead-free.
 3. Halogen- and Antimony-free "Green" products are defined as those which contain <900ppm bromine, <900ppm chlorine (<1500ppm total Br + Cl) and <1000ppm antimony compounds.

Pin Assignments

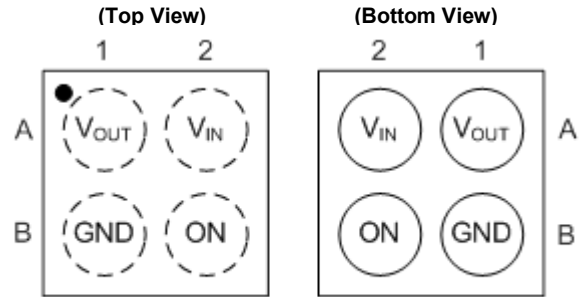

X1-WLB0909-4 & U-WLB0909-4

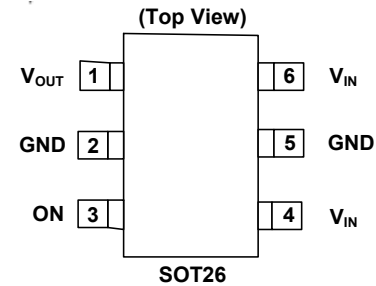

SOT26

Applications

- Mobile Device and Smart Phones
- Portable Media Devices
- Wearable Devices
- Advanced Notebook, UMPC and MID
- Portable Medical Devices
- GPS and Navigation Equipment
- Portable Instrumentation

Typical Applications Circuit

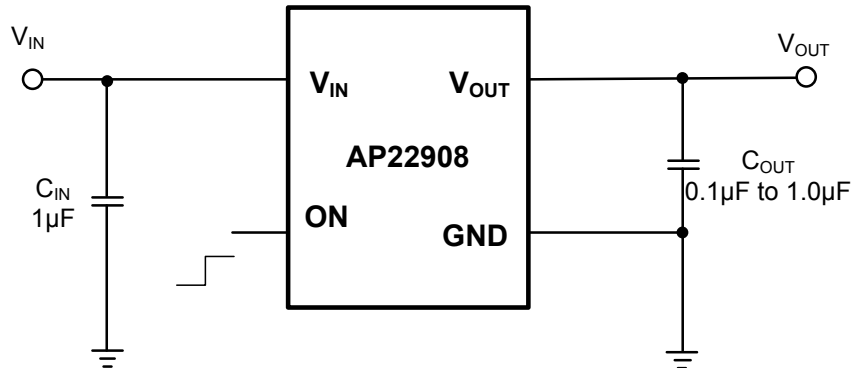

Pin Descriptions

| Pin Name | Pin Number | | Function |
|------------------|------------|-----------------------------|--|
| | SOT26 | X1-WLB0909-4 U-WLB0909-4 | |
| V _{OUT} | 1 | A1 | Voltage output pin. This is the pin to the P-channel MOSFET drain connection. Bypass to ground through a 0.1µF to 1µF capacitor. |
| V _{IN} | 4, 6 | A2 | Voltage input pin. This is the pin to the P-channel MOSFET source. Bypass to ground through a 1µF capacitor. |
| GND | 2, 5 | B1 | Ground |
| ON | 3 | B2 | Enable input, active high |

Functional Block Diagram

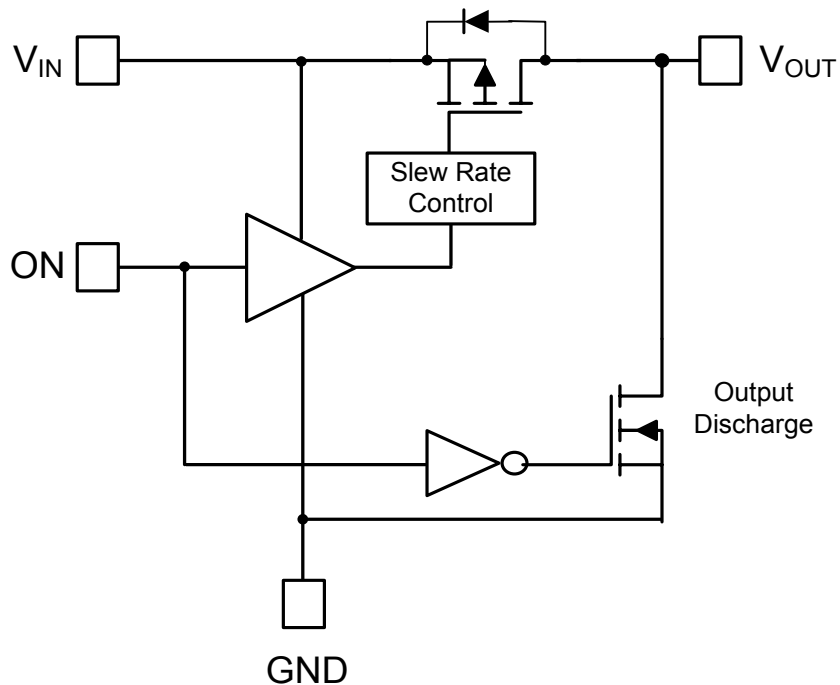

Absolute Maximum Ratings (@ T_A = +25°C, unless otherwise specified.)

| Symbol | Parameter | Ratings | | Unit |
|------------------|--|-----------------------------|-----|------|
| ESD HBM | Human Body Model ESD Protection | 2 | | kV |
| ESD CDM | Charged Device Model ESD Protection | 1 | | kV |
| V _{IN} | Input Voltage | -0.3 to 4 | | V |
| V _{OUT} | Output Voltage | -0.3 to 4 | | V |
| V _{ON} | ON Voltage | -0.3 to 4 | | V |
| I _{OUT} | Maximum Continuous Output Current (V _{IN} □ 1.2V) | 1.5 | | A |
| I _{OUT} | Maximum Pulse Output Current, Pulse <300µs, 2% Duty Cycle | 2.5 | | A |
| T _J | Maximum Junction Temperature | +125 | | °C |
| T _{STG} | Storage Temperature Range | -65 to +150 | | °C |
| P _D | Power Dissipation | X1-WLB0909-4 U-WLB0909-4 | 735 | mW |
| | | SOT26 | 606 | mW |
| R _{θJA} | Thermal Resistance, Junction to Ambient (Note 4) | X1-WLB0909-4 U-WLB0909-4 | 136 | °C/W |
| | | SOT26 | 165 | °C/W |
| R _{θJC} | Thermal Resistance, Junction to Case (Note 5) | X1-WLB0909-4 U-WLB0909-4 | 31 | °C/W |
| | | SOT26 | 30 | °C/W |

Notes: 4. The JEDEC high-K (2s2p) board used to derive this data was a 3 inch × 3 inch, multilayer board with 1oz internal power and ground planes with 2oz copper traces on top and bottom of the board.

5. Thermal resistance from junction to case.

Caution: Stresses greater than the 'Absolute Maximum Ratings' specified above, can cause permanent damage to the device. These are stress ratings only; functional operation of the device at these or any other conditions exceeding those indicated in this specification is not implied. Device reliability can be affected by exposure to absolute maximum rating conditions for extended periods of time.

Recommended Operating Conditions (@ T_A = +25°C, unless otherwise specified.)

| Symbol | Parameter | Min | Max | Unit |
|------------------|-------------------------------|------|------|------|
| V _{IN} | Input Voltage | 1.08 | 3.6 | V |
| V _{ON} | ON Voltage Range | 0 | 3.6 | V |
| V _{OUT} | Output Voltage | 0 | 3.6 | V |
| I _{OUT} | Output Current | 0 | 1.5 | A |
| V _{IH} | ON High-Level Input Voltage | 0.9 | 3.6 | V |
| V _{IL} | ON Low-Level Input Voltage | 0 | 0.38 | V |
| T _A | Operating Ambient Temperature | -40 | +85 | °C |

Electrical Characteristics ($T_A = -40^\circ\text{C}$ to $+85^\circ\text{C}$, $V_{IN} = 1.08\text{V}$ to 3.6V , $V_{ON} = V_{IN}(\text{enabled})$, $V_{ON} = 0\text{V}(\text{disabled})$, $C_{IN} = 1\mu\text{F}$, $C_{OUT} = 0.1\mu\text{F}$, typical values are at $T_A = +25^\circ\text{C}$, unless otherwise specified.) (Note 6)

| Symbol | Parameters | Test Conditions | | Min | Typ | Max | Unit | |
|-------------------------|---|---|--|-----|------|-----|---------------|------------|
| I_Q | Input Quiescent Current | $I_{OUT} = 0\text{mA}$, $V_{ON} = V_{IN}(\text{Enabled})$ | $T_A = -40^\circ\text{C}$ to $+85^\circ\text{C}$ | — | 0.05 | 1 | μA | |
| I_{SHDN} | Input Shutdown Current | $R_L = 1\text{M}\Omega$, $V_{ON} = \text{Disabled}$ | $T_A = -40^\circ\text{C}$ to $+85^\circ\text{C}$ | — | 0.04 | 0.5 | μA | |
| I_{IN_LEAK} | Input Leakage Current | $V_{OUT} = 0\text{V}$, $V_{ON} = \text{Disabled}$ | $T_A = -40^\circ\text{C}$ to $+85^\circ\text{C}$ | — | 0.04 | 0.5 | μA | |
| I_{ON} | ON Input leakage | $V_{ON} = 1.1\text{V}$ to 3.6V or $V_{ON} = V_{IN}$ | $T_A = -40^\circ\text{C}$ to $+85^\circ\text{C}$ | — | 0.01 | 0.1 | μA | |
| $R_{DS(\text{ON})}$ | X1-WLB0909-4 & U-WLB0909-4 Package, Switch On-Resistance, $I_{OUT} = -200\text{mA}$ | $V_{IN} = 3.6\text{V}$ | $T_A = +25^\circ\text{C}$ | — | 28 | 32 | m Ω | |
| | | | $T_A = -40^\circ\text{C}$ to $+85^\circ\text{C}$ | — | — | 40 | | |
| | | $V_{IN} = 2.5\text{V}$ | $T_A = +25^\circ\text{C}$ | — | 33 | 38 | | |
| | | | $T_A = -40^\circ\text{C}$ to $+85^\circ\text{C}$ | — | — | 45 | | |
| | | $V_{IN} = 1.8\text{V}$ | $T_A = +25^\circ\text{C}$ | — | 41 | 50 | | |
| | | | $T_A = -40^\circ\text{C}$ to $+85^\circ\text{C}$ | — | — | 54 | | |
| | $V_{IN} = 1.2\text{V}$ | $T_A = +25^\circ\text{C}$ | — | 69 | 87 | | | |
| | | $T_A = -40^\circ\text{C}$ to $+85^\circ\text{C}$ | — | — | 91 | | | |
| | SOT26 Package, Switch On-Resistance, $I_{OUT} = -200\text{mA}$ | $V_{IN} = 3.6\text{V}$ | $T_A = +25^\circ\text{C}$ | — | 40 | 43 | | m Ω |
| | | | $T_A = -40^\circ\text{C}$ to $+85^\circ\text{C}$ | — | — | 55 | | |
| | | $V_{IN} = 2.5\text{V}$ | $T_A = +25^\circ\text{C}$ | — | 45 | 49 | | |
| | | | $T_A = -40^\circ\text{C}$ to $+85^\circ\text{C}$ | — | — | 59 | | |
| $V_{IN} = 1.8\text{V}$ | | $T_A = +25^\circ\text{C}$ | — | 53 | 62 | | | |
| | | $T_A = -40^\circ\text{C}$ to $+85^\circ\text{C}$ | — | — | 69 | | | |
| $V_{IN} = 1.2\text{V}$ | $T_A = +25^\circ\text{C}$ | — | 91 | 110 | | | | |
| | $T_A = -40^\circ\text{C}$ to $+85^\circ\text{C}$ | — | — | 120 | | | | |
| $V_{IN} = 1.08\text{V}$ | $T_A = +25^\circ\text{C}$ | — | 120 | 175 | | | | |
| | $T_A = -40^\circ\text{C}$ to $+85^\circ\text{C}$ | — | — | 185 | | | | |
| R_{DIS} | Discharge FET On-Resistance | $V_{IN} = 3.3\text{V}$, $V_{ON} = 0\text{V}$, $I_{OUT} = 30\text{mA}$, $T_A = +25^\circ\text{C}$ | | — | 80 | 100 | Ω | |

Notes: 6. Specifications are over -40°C to $+85^\circ\text{C}$ and are guaranteed by characterization and design.

Timing Characteristics (Note 7)

| Symbol | Parameters | Test Conditions | Min | Typ | Max | Unit |
|-----------|----------------------|---|-----|-----|-----|---------|
| t_{ON} | Output Turn-On Time | $V_{IN} = 3.6V, R_L = 10\Omega, C_{OUT} = 0.1\mu F, T_A = +25^\circ C$ | — | 110 | — | μs |
| t_{OFF} | Output Turn-Off Time | | — | 5 | — | μs |
| t_R | Output Rise Time | | — | 105 | — | μs |
| t_F | Output Fall Time | | — | 2 | — | μs |
| t_{ON} | Output Turn-On Time | $V_{IN} = 1.08V, R_L = 10\Omega, C_{OUT} = 0.1\mu F, T_A = +25^\circ C$ | — | 900 | — | μs |
| t_{OFF} | Output Turn-Off Time | | — | 5 | — | μs |
| t_R | Output Rise Time | | — | 442 | — | μs |
| t_F | Output Fall Time | | — | 2 | — | μs |

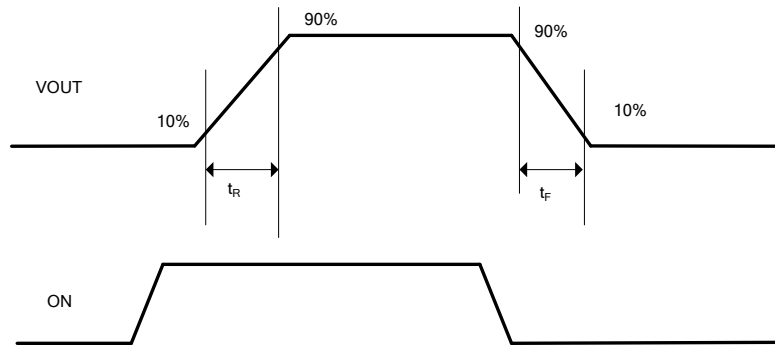

Output Rise (t_R) and Fall (t_F) Time

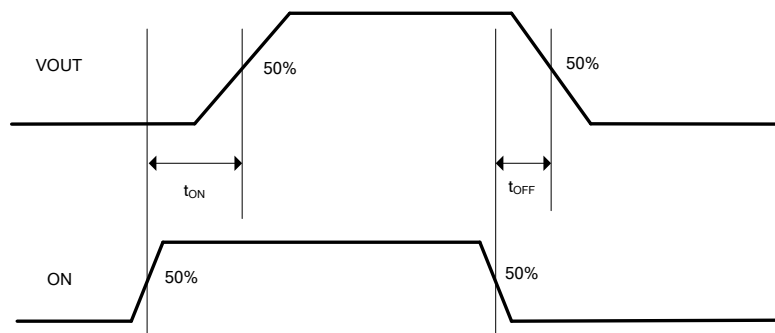

Output Turn On (t_{ON}) and Turn Off (t_{OFF}) time

Notes: 7. Rise and fall time of the control signal are less than 100ns.

Typical Performance Characteristics ($C_{IN} = 1\mu F$, $C_{OUT} = 0.1\mu F$, unless otherwise specified.)

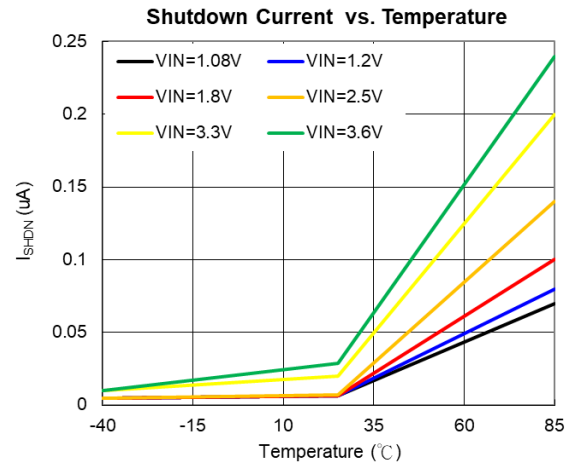
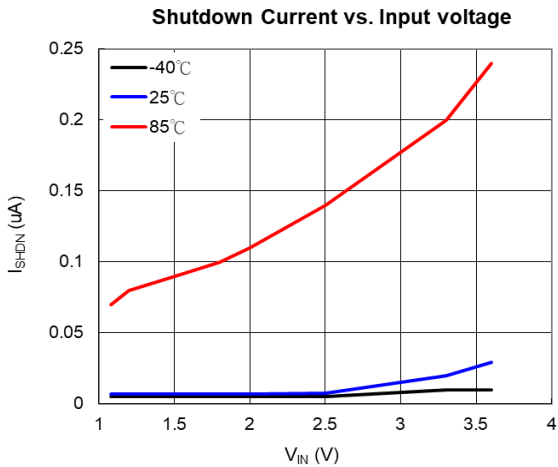
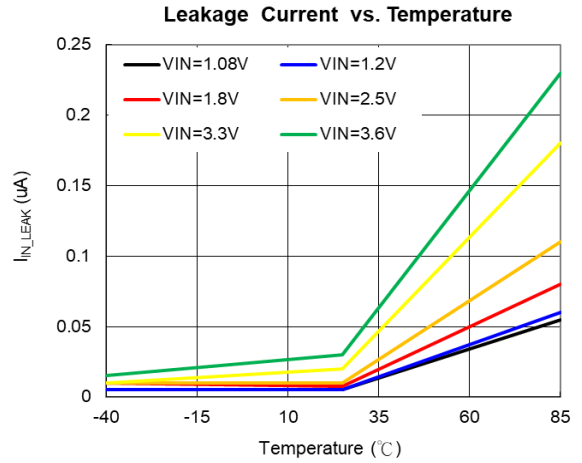
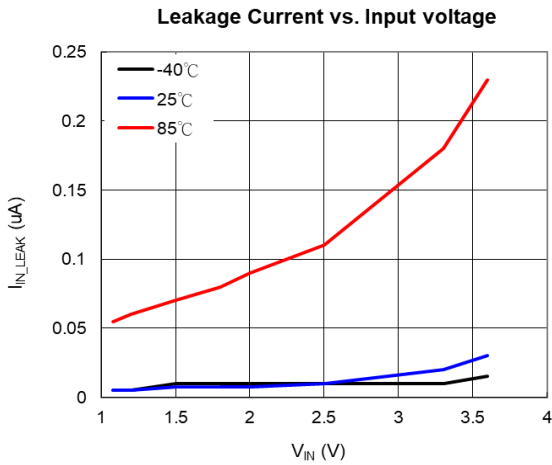
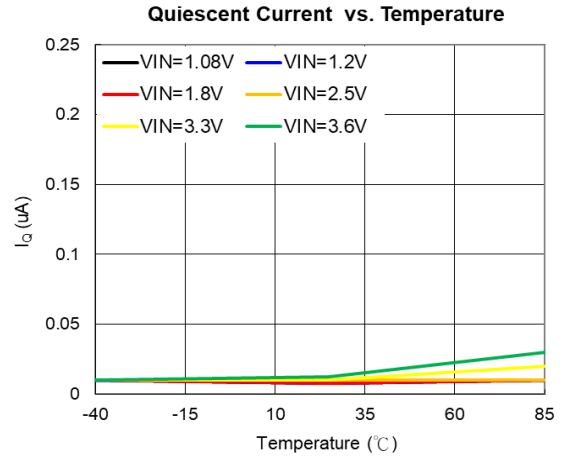
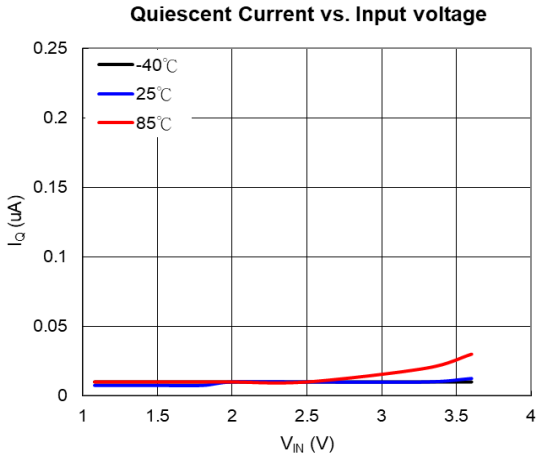

Typical Performance Characteristics ($C_{IN} = 1\mu F$, $C_{OUT} = 0.1\mu F$, unless otherwise specified.)

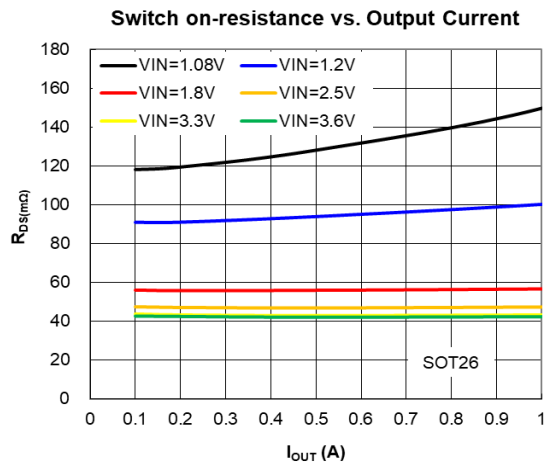
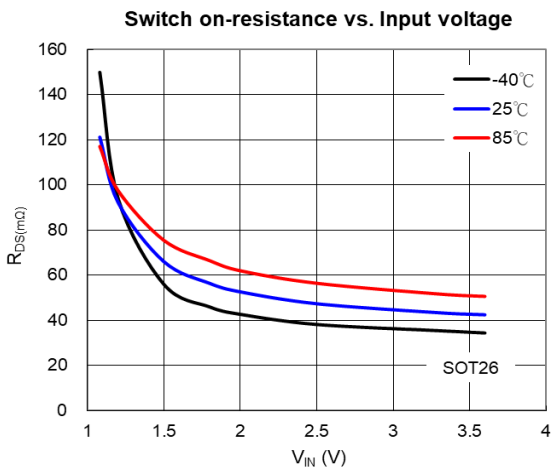
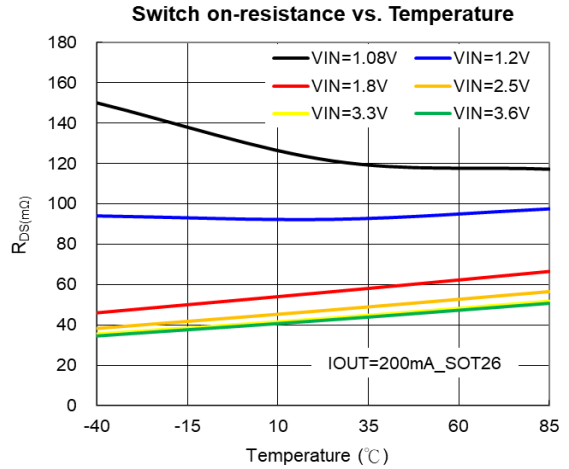
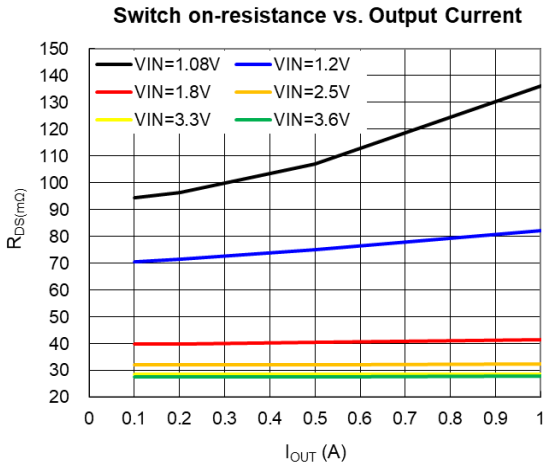
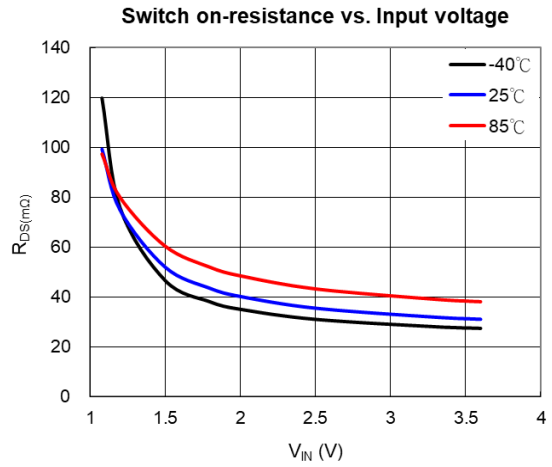
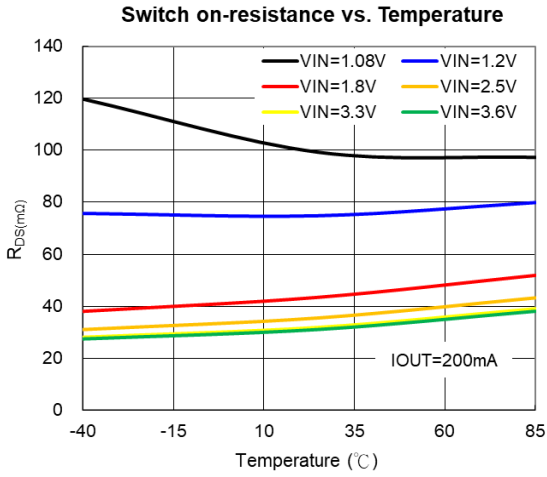

Typical Performance Characteristics ($C_{IN} = 1\mu F$, $C_{OUT} = 0.1\mu F$, unless otherwise specified.)

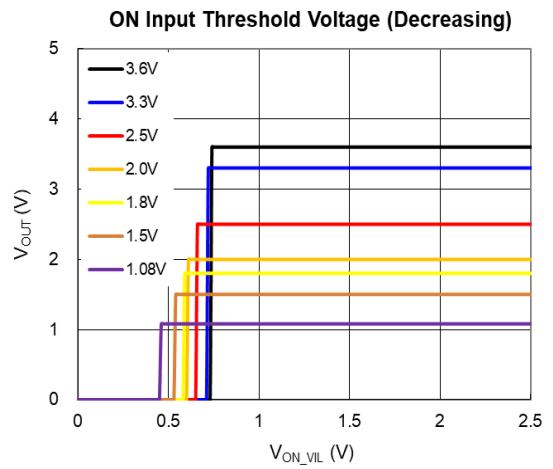
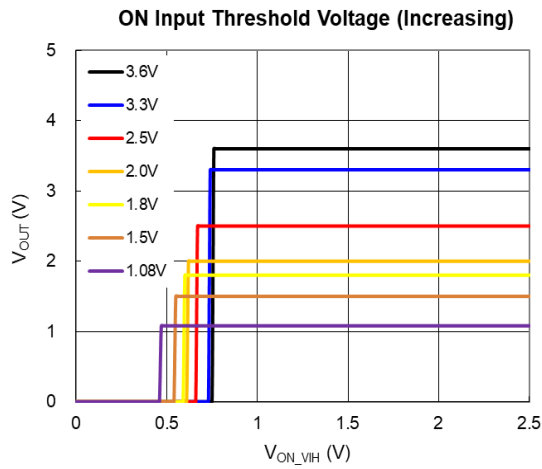
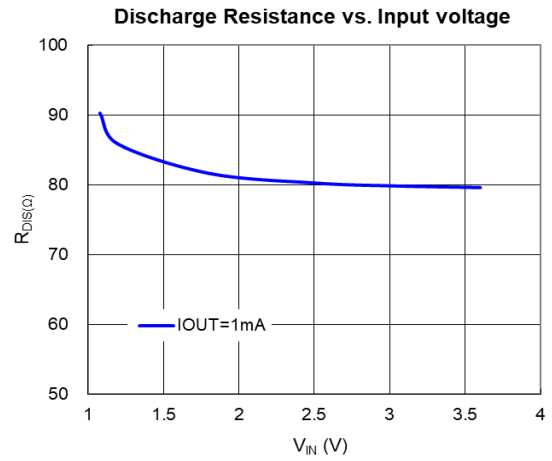
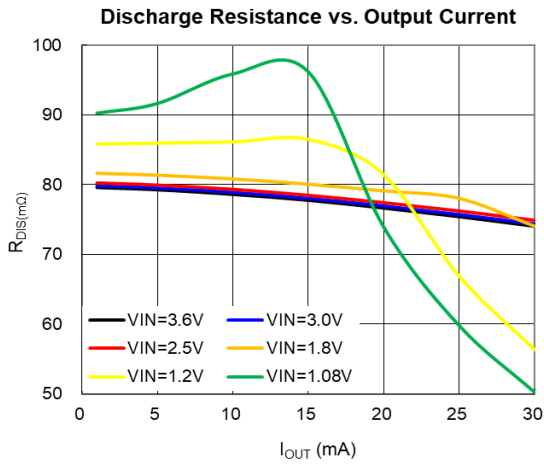

Typical Performance Characteristics ($C_{IN} = 1\mu F$, $C_{OUT} = 0.1\mu F$, $R_L = 10\Omega$, unless otherwise specified.)

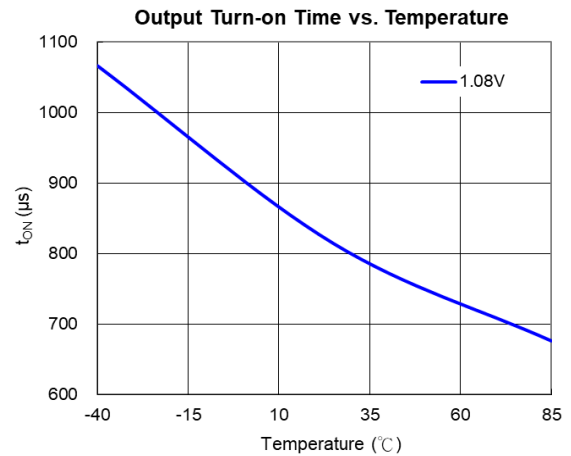
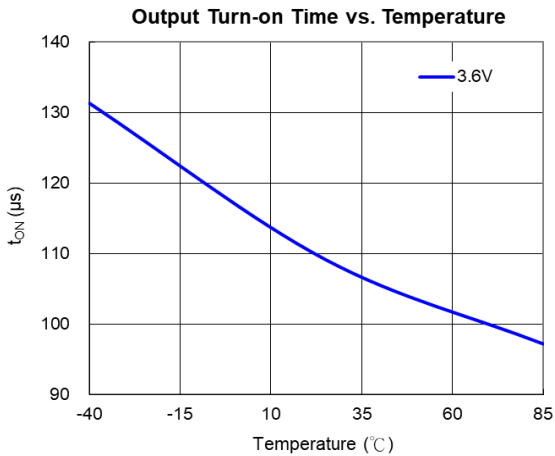
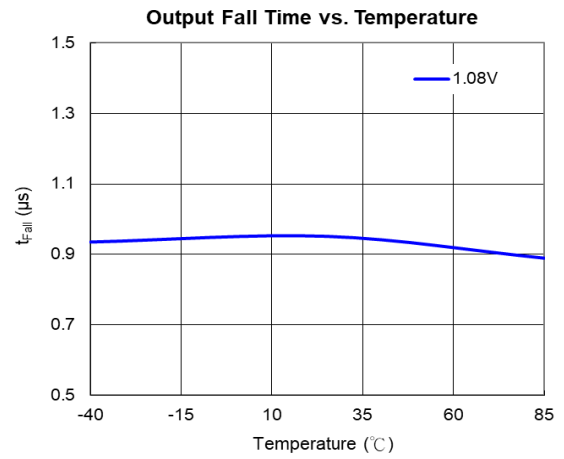
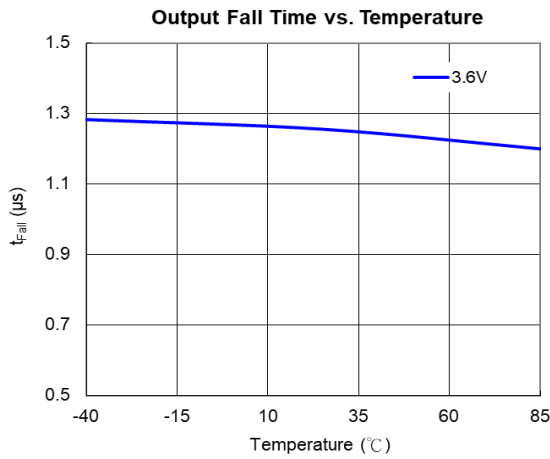
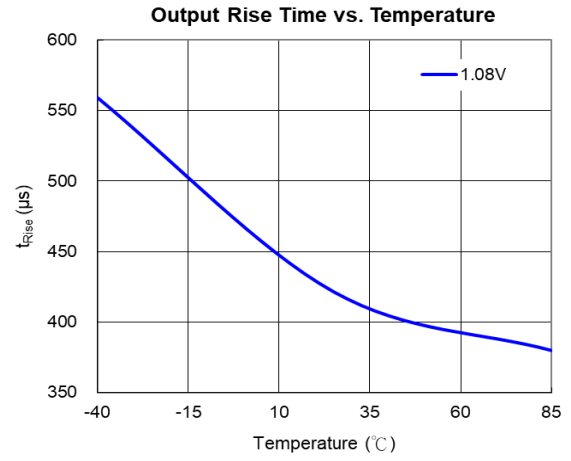
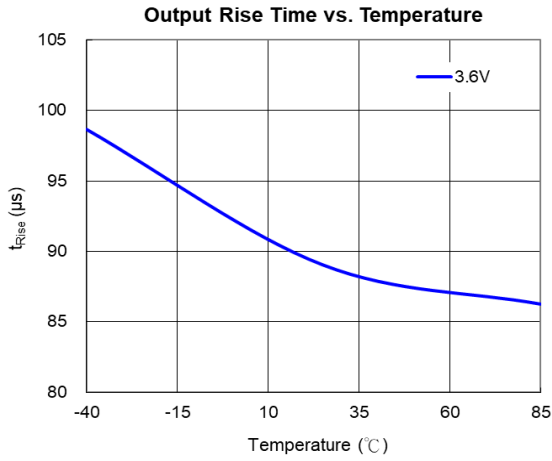

Typical Performance Characteristics ($C_{IN} = 1\mu F$, $C_{OUT} = 0.1\mu F$, $R_L = 10\Omega$, unless otherwise specified.)

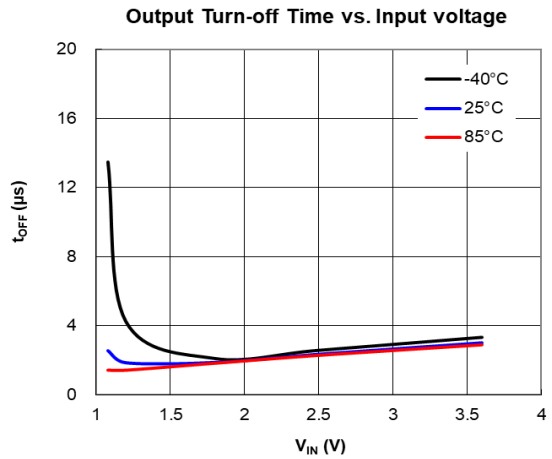
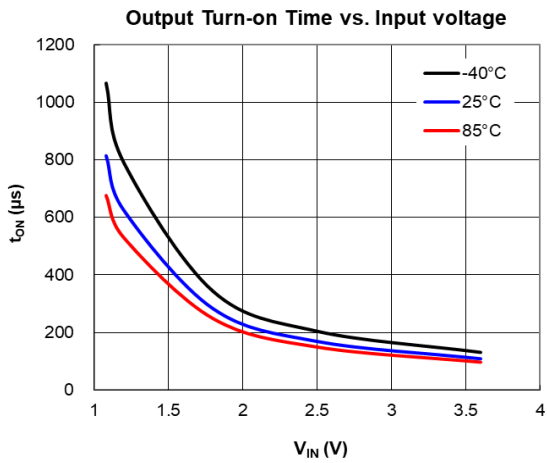
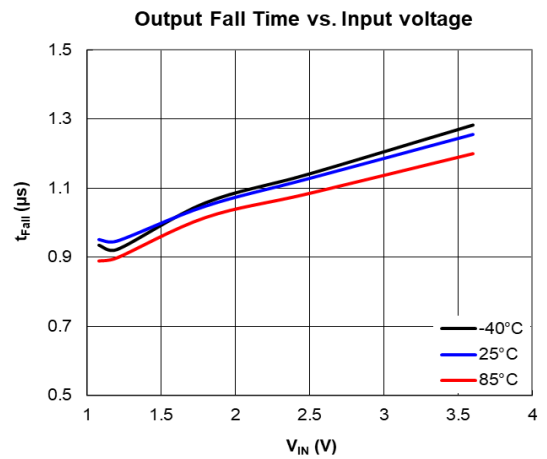
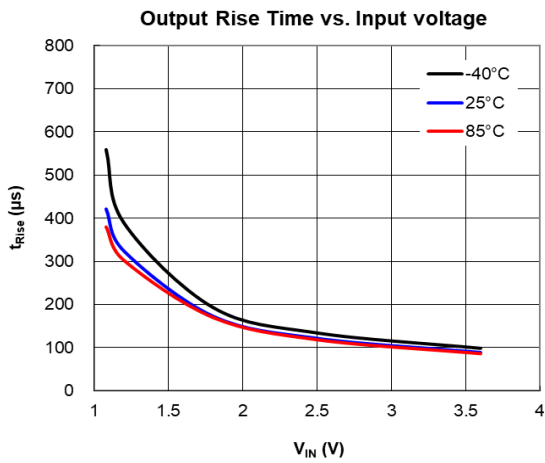
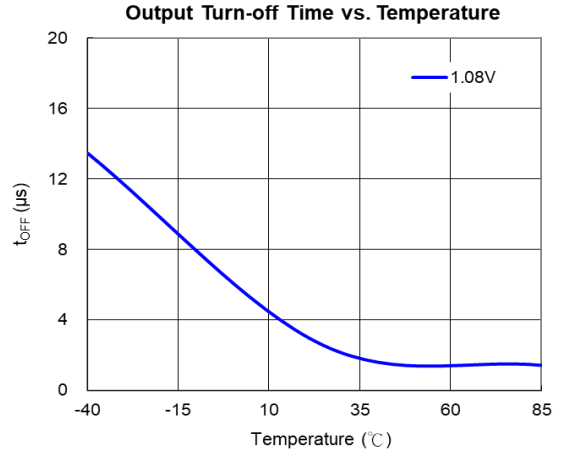
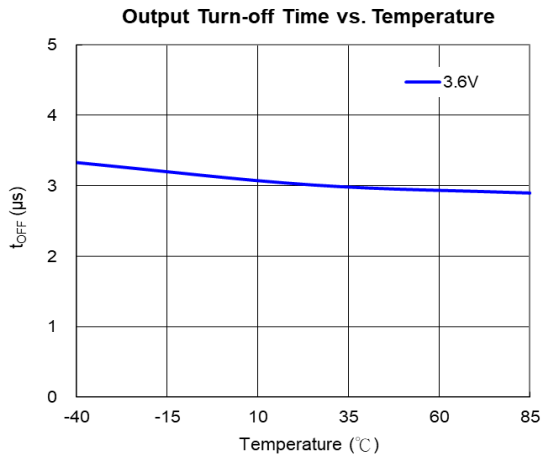

Typical Performance Characteristics ($C_{IN} = 1\mu F$, $C_{OUT} = 0.1\mu F$, $R_L = 10\Omega$, unless otherwise specified.)

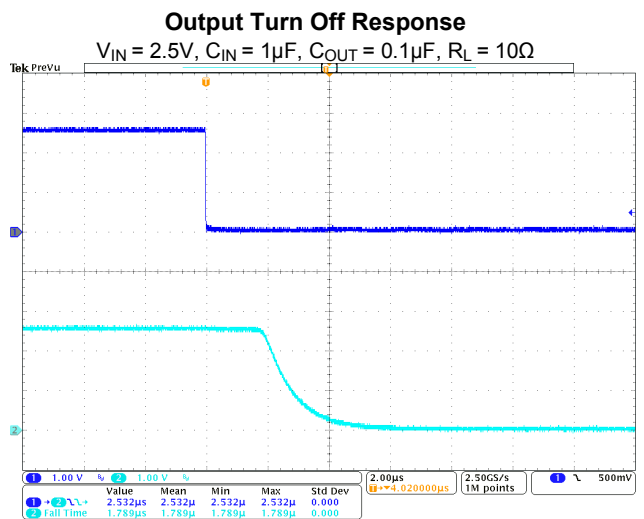
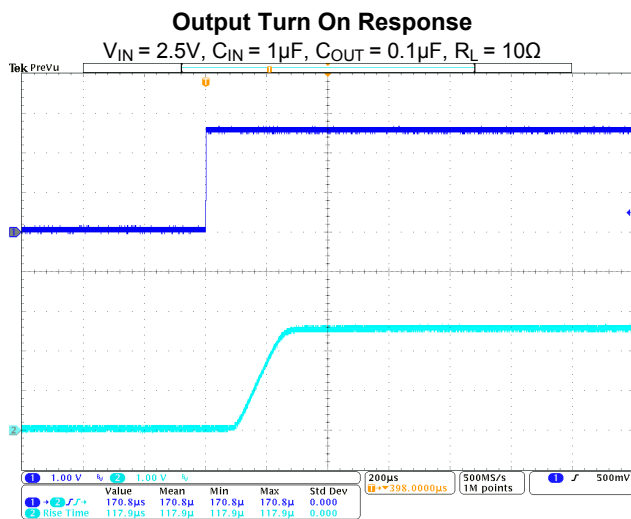
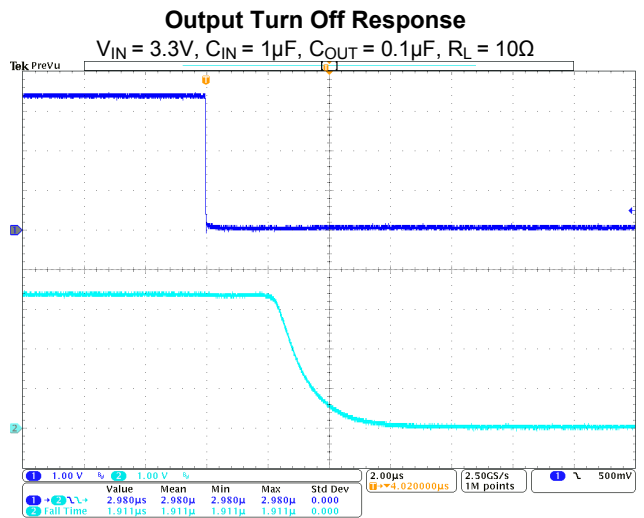
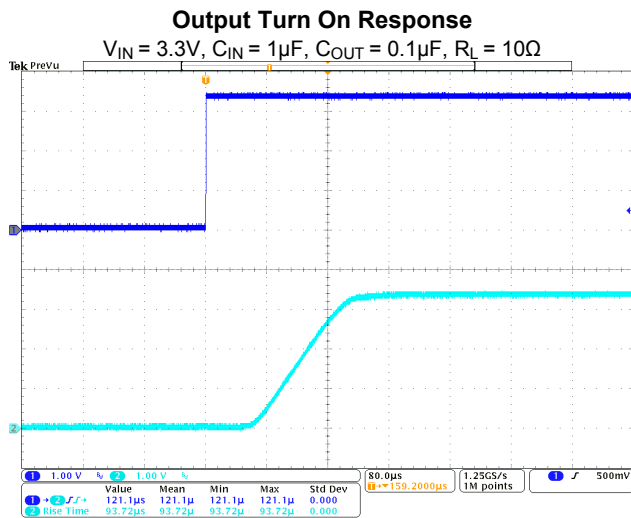
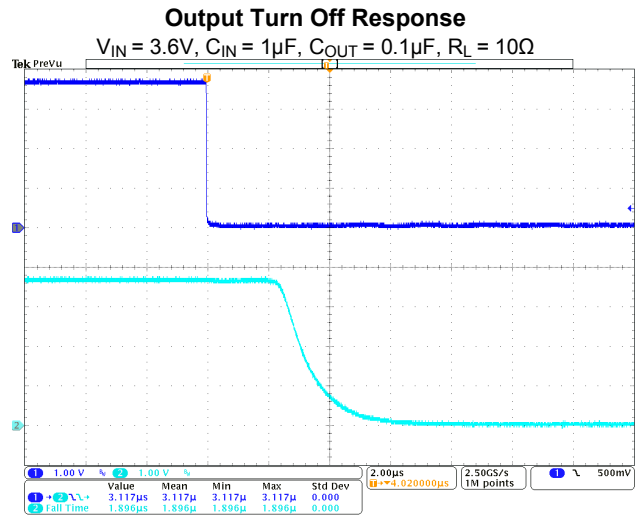
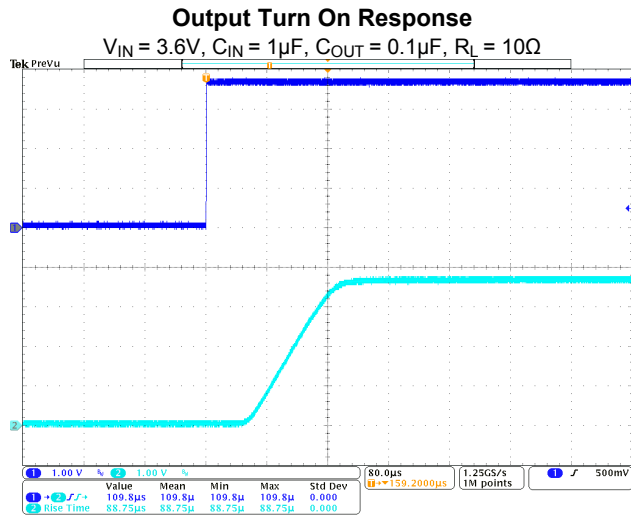

Typical Performance Characteristics ($C_{IN} = 1\mu F$, $C_{OUT} = 0.1\mu F$, $R_L = 10\Omega$, unless otherwise specified.)

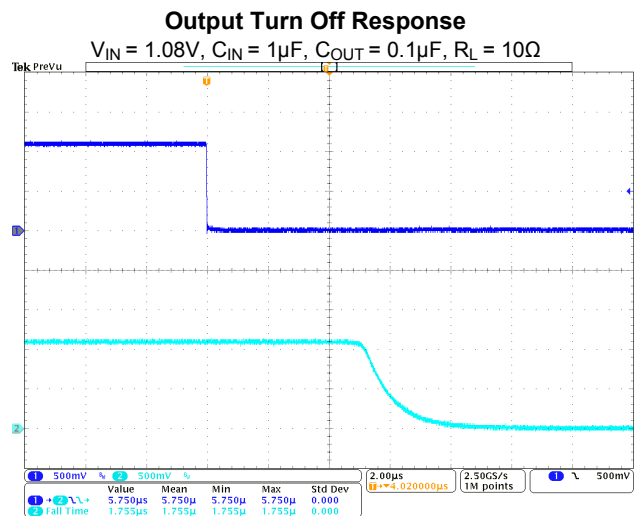
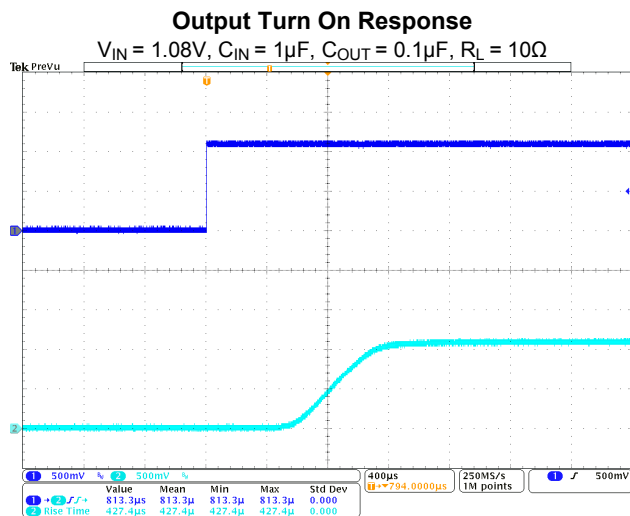
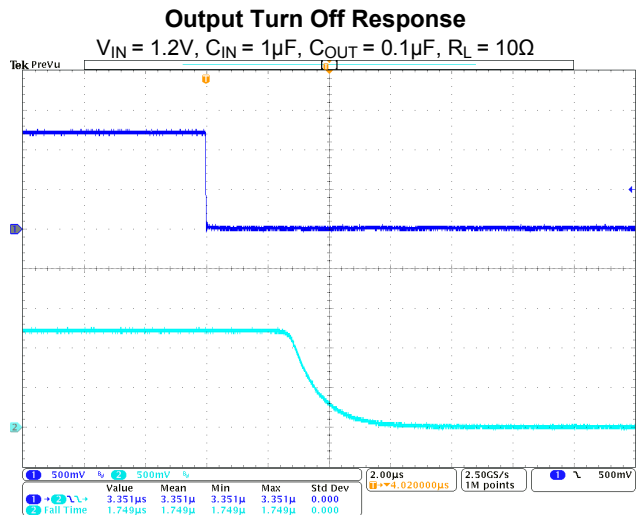
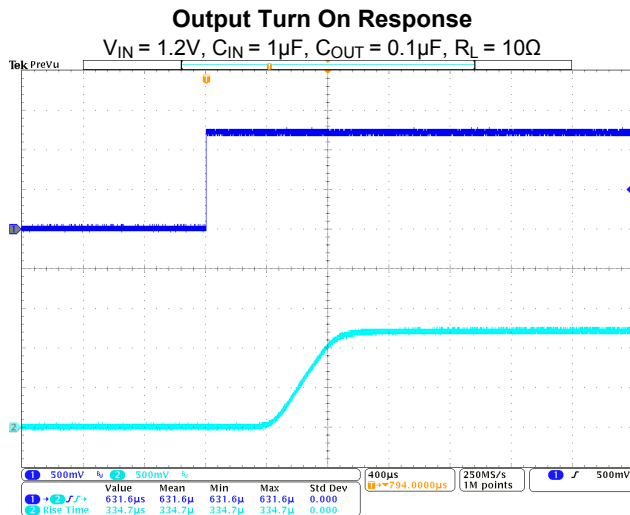
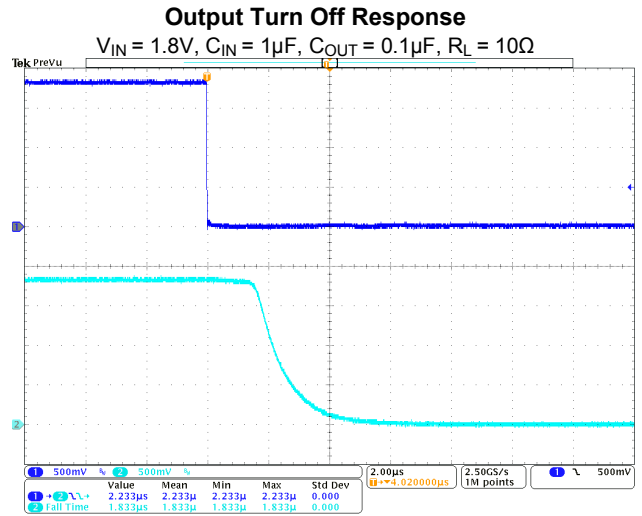
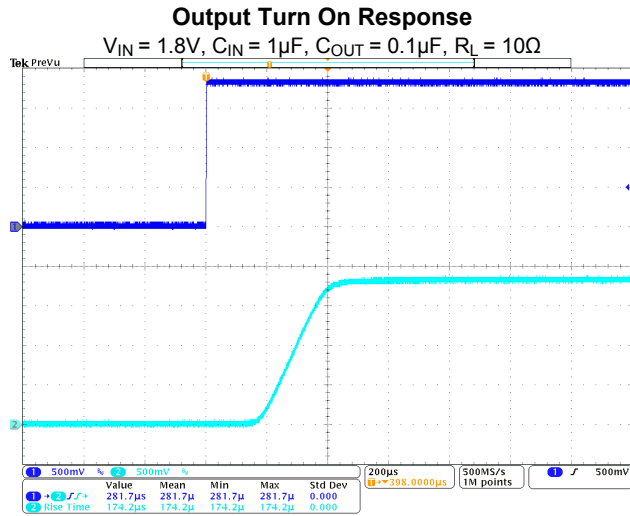

Application Information

Input Capacitor

A 1μF capacitor is recommended to connect between the V_{IN} and GND pins to decouple input power supply glitch and noise. The input capacitor has no specific type or ESR (Equivalent Series Resistance) requirement. However, for higher current application, ceramic capacitors are recommended due to their capability to withstand input current surges from low impedance sources, such as batteries in portable applications. This input capacitor must be located as close as possible to the device to assure input stability and less noise. For PCB layout, a wide copper trace is required for both V_{IN} and GND.

Output Capacitor

The 0.1μF to 1μF capacitor is recommended to connect between V_{OUT} and GND pins to stabilize and accommodate load transient condition. The output capacitor has no specific type or ESR requirement. The amount of the capacitance may be increased without limit. For PCB layout, the output capacitor must be placed as close as possible to V_{OUT} and GND pins, and keep the traces as short as possible.

Enable/Shutdown Operation

The AP22908 is turned on by setting the ON pin high, and is turned off by pulling it low. To ensure proper operation, the signal source used to drive the ON pin must be able to swing above and below the specified turn-on/off voltage thresholds listed in the *Electrical Characteristics* section under V_{IL} and V_{IH}.

Discharge Operation

The AP22908 offers a discharge option that helps discharge the output charge when disabled. The discharge resistance with a typical value of 80Ω is connected between the output and ground.

Power Dissipation

The maximum IC junction temperature should be restricted to +125°C under normal operating conditions. The device power dissipation and proper sizing of the thermal plane is critical to avoid thermal shutdown and ensure reliable operation. Power dissipation of the device depends on input voltage and load conditions and can be calculated by:

$$P_D = I_{OUT}^2 \times R_{DSON} \quad (1)$$

However, the maximum power dissipation that can be handled by the device depends on the maximum junction to ambient thermal resistance, maximum ambient temperature, and maximum device junction temperature, which can be approximated by the equation below:

$$P_{D(MAX)} = \frac{(125^\circ\text{C} - T_A)}{\theta_{JA}} \quad (2)$$

Layout Guideline

Good PCB layout is important for improving the thermal performance of the device. All trace lengths should be kept as short as possible. The input (V_{IN}) and output (V_{OUT}) PCB traces should be as wide as possible to reduce stray impedance.

Use a ground plane to enhance the power dissipation capability of the device if applicable. Place input and output capacitors close to the device to minimize the effects of parasitic inductance.

Ordering Information

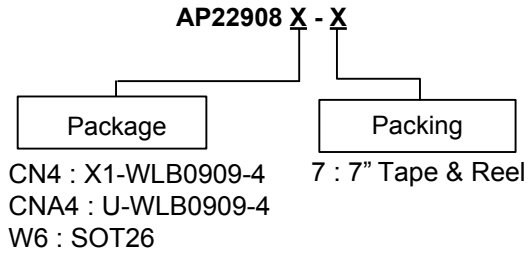

| Part Number | Package Code | Packaging | 7" Tape and Reel | |
|---------------|--------------|--------------|-------------------|--------------------|
| | | | Quantity | Part Number Suffix |
| AP22908CN4-7 | CN4 | X1-WLB0909-4 | 3,000/Tape & Reel | -7 |
| AP22908CNA4-7 | CNA4 | U-WLB0909-4 | 3,000/Tape & Reel | -7 |
| AP22908W6-7 | W6 | SOT26 | 3,000/Tape & Reel | -7 |

Feature Options:

| Part Number | Rise Time (Typ) at 3.6V | Output Discharge | Enable |
|---------------|-------------------------|------------------|-------------|
| AP22908CN4-7 | 105µs | Yes | Active High |
| AP22908CNA4-7 | 105µs | Yes | Active High |
| AP22908W6-7 | 105µs | Yes | Active High |

Marking Information

(1) X1-WLB0909-4

(Top View)

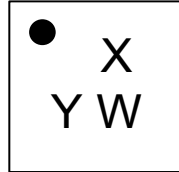

X : Identification Code
 Y : Year : 0~9
 W : Week : A~Z : 1~26 week;
 a~z : 27~52 week; z represents
 52 and 53 week

| Part Number | Package | Identification Code |
|--------------|--------------|---------------------|
| AP22908CN4-7 | X1-WLB0909-4 | $\bar{4}$ |

(2) U-WLB0909-4

(Top View)

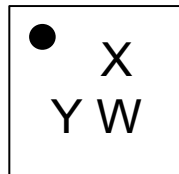

X : Identification Code
 Y : Year : 0~9
 W : Week : A~Z : 1~26 week;
 a~z : 27~52 week; z represents
 52 and 53 week

| Part Number | Package | Identification Code |
|---------------|-------------|---------------------|
| AP22908CNA4-7 | U-WLB0909-4 | $\bar{8}$ |

(3) SOT25

(Top View)

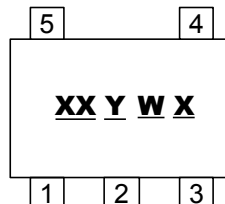

XX : Identification Code
Y : Year 0 to 9
W : Week : A to Z : 1 to 26 week;
 a to z : 27 to 52 week; z represents
 52 and 53 week
 X : Internal Code

| Part Number | Package | Identification Code |
|-------------|---------|---------------------|
| AP22908W5-7 | SOT25 | N8 |

Package Outline Dimensions

Please see <http://www.diodes.com/package-outlines.html> for the latest version.

(1) Package Type: X1-WLB0909-4

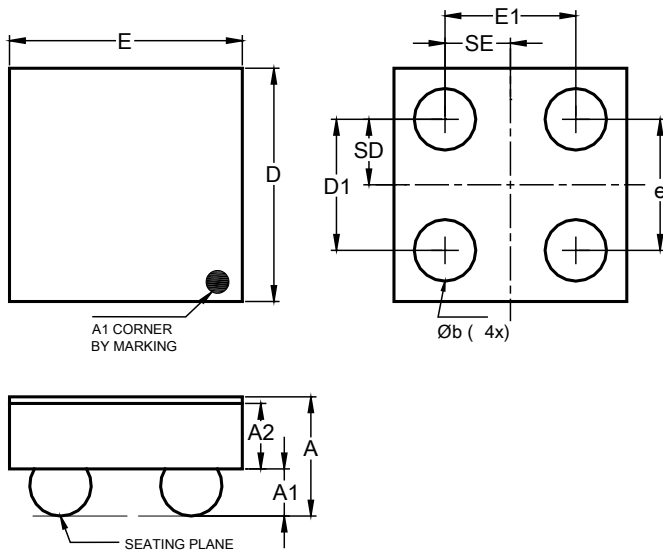

| X1-WLB0909-4 | | | |
|----------------------|-----------|-------|-------|
| Dim | Min | Max | Typ |
| A | 0.410 | 0.500 | 0.455 |
| A1 | 0.160 | 0.200 | 0.180 |
| A2 | 0.225 | 0.275 | 0.250 |
| b | 0.215 | 0.255 | 0.235 |
| D | 0.840 | 0.900 | 0.870 |
| D1 | 0.450 | 0.550 | 0.500 |
| E | 0.840 | 0.900 | 0.870 |
| E1 | 0.450 | 0.550 | 0.500 |
| e | 0.500 BSC | | |
| SD | 0.250 BSC | | |
| SE | 0.250 BSC | | |
| All Dimensions in mm | | | |

(2) Package Type: U-WLB0909-4

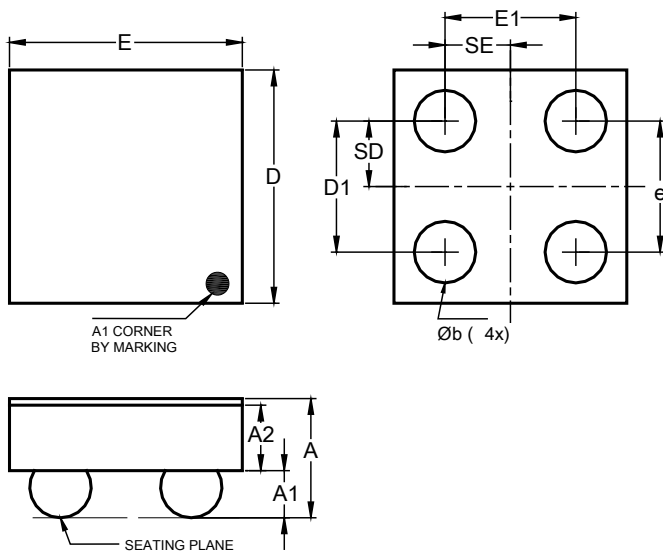

| U-WLB0909-4 | | | |
|----------------------|-----------|-------|-------|
| Dim | Min | Max | Typ |
| A | 0.540 | 0.630 | 0.585 |
| A1 | 0.160 | 0.200 | 0.180 |
| A2 | 0.355 | 0.405 | 0.380 |
| b | 0.205 | 0.265 | 0.235 |
| D | 0.860 | 0.920 | 0.880 |
| D1 | 0.450 | 0.550 | 0.500 |
| E | 0.860 | 0.920 | 0.880 |
| E1 | 0.450 | 0.550 | 0.500 |
| e | 0.500 BSC | | |
| SD | 0.250 BSC | | |
| SE | 0.250 BSC | | |
| All Dimensions in mm | | | |

Package Outline Dimensions (Continued)

Please see <http://www.diodes.com/package-outlines.html> for the latest version.

(3) Package Type: SOT26

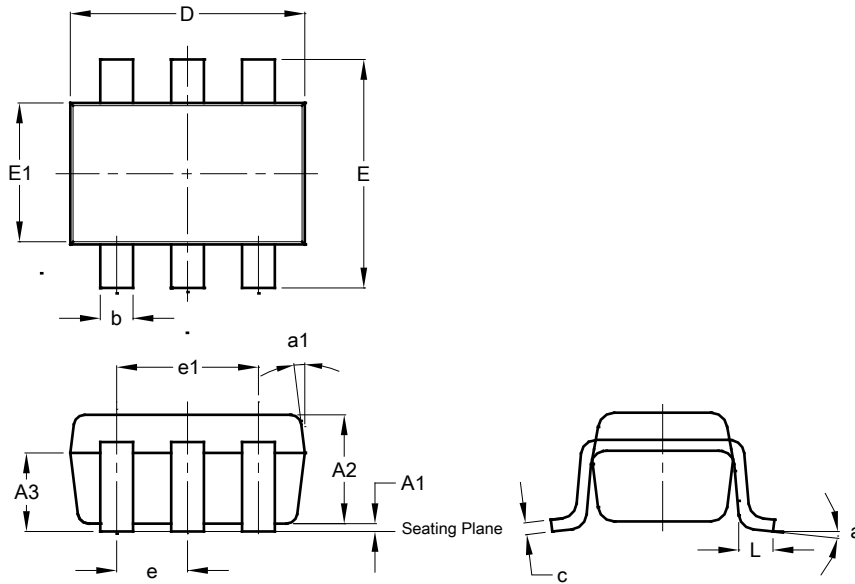

| SOT26 | | | |
|----------------------|-------|------|------|
| Dim | Min | Max | Typ |
| A1 | 0.013 | 0.10 | 0.05 |
| A2 | 1.00 | 1.30 | 1.10 |
| A3 | 0.70 | 0.80 | 0.75 |
| b | 0.35 | 0.50 | 0.38 |
| c | 0.10 | 0.20 | 0.15 |
| D | 2.90 | 3.10 | 3.00 |
| e | - | - | 0.95 |
| e1 | - | - | 1.90 |
| E | 2.70 | 3.00 | 2.80 |
| E1 | 1.50 | 1.70 | 1.60 |
| L | 0.35 | 0.55 | 0.40 |
| a | - | - | 8° |
| a1 | - | - | 7° |
| All Dimensions in mm | | | |

Suggested Pad Layout

Please see <http://www.diodes.com/package-outlines.html> for the latest version.

(1) Package Type: X1-WLB0909-4 & U-WLB0909-4

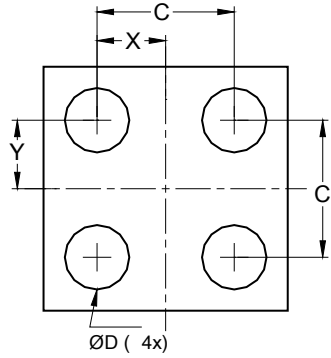

| Dimensions | Value (in mm) |
|------------|---------------|
| C | 0.500 |
| D | 0.235 |
| X | 0.250 |
| Y | 0.250 |

(2) Package Type: SOT26

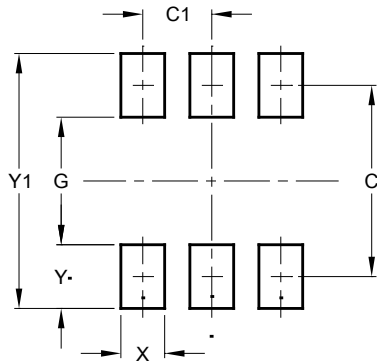

| Dimensions | Value (in mm) |
|------------|---------------|
| C | 2.40 |
| C1 | 0.95 |
| G | 1.60 |
| X | 0.55 |
| Y | 0.80 |
| Y1 | 3.20 |

IMPORTANT NOTICE

DIODES INCORPORATED MAKES NO WARRANTY OF ANY KIND, EXPRESS OR IMPLIED, WITH REGARDS TO THIS DOCUMENT, INCLUDING, BUT NOT LIMITED TO, THE IMPLIED WARRANTIES OF MERCHANTABILITY AND FITNESS FOR A PARTICULAR PURPOSE (AND THEIR EQUIVALENTS UNDER THE LAWS OF ANY JURISDICTION).

Diodes Incorporated and its subsidiaries reserve the right to make modifications, enhancements, improvements, corrections or other changes without further notice to this document and any product described herein. Diodes Incorporated does not assume any liability arising out of the application or use of this document or any product described herein; neither does Diodes Incorporated convey any license under its patent or trademark rights, nor the rights of others. Any Customer or user of this document or products described herein in such applications shall assume all risks of such use and will agree to hold Diodes Incorporated and all the companies whose products are represented on Diodes Incorporated website, harmless against all damages.

Diodes Incorporated does not warrant or accept any liability whatsoever in respect of any products purchased through unauthorized sales channel. Should Customers purchase or use Diodes Incorporated products for any unintended or unauthorized application, Customers shall indemnify and hold Diodes Incorporated and its representatives harmless against all claims, damages, expenses, and attorney fees arising out of, directly or indirectly, any claim of personal injury or death associated with such unintended or unauthorized application.

Products described herein may be covered by one or more United States, international or foreign patents pending. Product names and markings noted herein may also be covered by one or more United States, international or foreign trademarks.

This document is written in English but may be translated into multiple languages for reference. Only the English version of this document is the final and determinative format released by Diodes Incorporated.

LIFE SUPPORT

Diodes Incorporated products are specifically not authorized for use as critical components in life support devices or systems without the express written approval of the Chief Executive Officer of Diodes Incorporated. As used herein:

- A. Life support devices or systems are devices or systems which:
 - 1. are intended to implant into the body, or
 - 2. support or sustain life and whose failure to perform when properly used in accordance with instructions for use provided in the labeling can be reasonably expected to result in significant injury to the user.
- B. A critical component is any component in a life support device or system whose failure to perform can be reasonably expected to cause the failure of the life support device or to affect its safety or effectiveness.

Customers represent that they have all necessary expertise in the safety and regulatory ramifications of their life support devices or systems, and acknowledge and agree that they are solely responsible for all legal, regulatory and safety-related requirements concerning their products and any use of Diodes Incorporated products in such safety-critical, life support devices or systems, notwithstanding any devices- or systems-related information or support that may be provided by Diodes Incorporated. Further, Customers must fully indemnify Diodes Incorporated and its representatives against any damages arising out of the use of Diodes Incorporated products in such safety-critical, life support devices or systems.

Copyright © 2020, Diodes Incorporated

www.diodes.com

单击下面可查看定价，库存，交付和生命周期等信息

[>>Diodes Incorporated\(达达科技\(美台\)\)](#)