



A Product Line of
Diodes Incorporated



SPECIFICATION FOR APPROVAL

CUSTOMER _____

NOMINAL FREQUENCY _____ 200.000000 MHz _____

PRODUCT TYPE _____ TYPE NX 5.0x3.2 SEAM SEALED CRYSTAL CLOCK OSCILLATOR _____

SPEC. NO. (P/N) _____ NX53K00002 _____

CUSTOMER P/N _____

ISSUE DATE _____ June 6, 2018 _____

VERSION _____ B _____

APPROVED	PREPARED	QA
<i>Brenda Kuo</i>	<i>Winnie Chang</i>	<i>Dony Yang</i>

Diodes Incorporated

No.2, Ziqiang 5th Rd., Zhongli Industrial Park,
Zhongli Dist., Taoyuan City 32063, Taiwan (R.O.C.)
TEL: 886-3-451-8888
FAX: 886-3-461-3865
<https://www.diodes.com>

*Pb-free
*RoHS Compliant
*HF-Halogen Free
*REACH Compliant

TYPE NX 5.0x3.2 SEAM SEALED CRYSTAL CLOCK OSCILLATOR

NX53K00002

VER. B 6-Jun-18

ELECTRICAL SPECIFICATIONS

SRe Part Number : NX53K00002

Item	Symbol	Specifications	Units	Notes
Nominal Frequency	F ₀	200.000000	MHz	
Frequency Stability	FT	± 25	ppm	**See note
Operating Temperature Range	TR	-40 to +85	°C	
Supply Voltage	V _{CC}	+3.3 ± 5.0%	V	
Logic Type	LT	LVDS		
Supply Current, Output Enabled	I _{CC/OE}	70	mA	Max.
Supply Current, Output Disabled	I _{CC/OD}	40	mA	Max.
Duty Cycle (Symmetry)	DC/SY	45 / 55	%	Measured 50% of Waveform
Rise / Fall Time	T _R /T _F	400	ps	Max. measured 20/80% of Waveform
Output Voltage "0" Level	V _{OL}	1.10 / 0.9	V	Typ. / Min.
Output Voltage "1" Level	V _{OH}	1.43 / 1.6	V	Typ. / Max.
Output Load		100Ω connected between outputs		Output requires termination
Differential Output Voltage	V _{OD}	247 / 454	mV	Min. / Max.
Jitter, Phase	RMS	0.4 / 0.6	ps	Typ /Max. 12KHz ~ 20MHz Frequency Band
Jitter, Accumulated	RMS(1-σ)	6	ps	Max. 20,000 Consecutive Periods
Jitter, Peak to Peak	Pk-Pk	40	ps	Max. 100,000 Random Periods
Storage Temperature Range		-55 to +125	°C	

※ This product doesn't include harmful substance that stipulated by SONY SS-00259 Level 1 and S-AT2-001 Level 1 standard. RoHS Compliant (Pb - Free).

**Stability includes all combinations of Operating Temperature, Load changes, rated Input (Supply) Voltage changes, Initial Calibration Tolerance (25°C), Aging (1 year at 25°C Average Effective Ambient Temperature), Shock and Vibration.

Output Enable / Disable Function

Parameter	Min.	Typ.	Max.	Units	Notes
Input Voltage (Pin1), Output Enable	0.7V _{CC}			V	Or Open
Input Voltage (Pin1), Output Disable (low power standby)			0.3V _{CC}	V	Output is Hi-Z
Output Disable Delay			100	ns	
Output Enable Delay			100	ns	
Start Up Time			10	ms	



TYPE NX 5.0x3.2 SEAM SEALED CRYSTAL CLOCK OSCILLATOR

NX53K00002

VER. B 6-Jun-18

TEST CIRCUIT

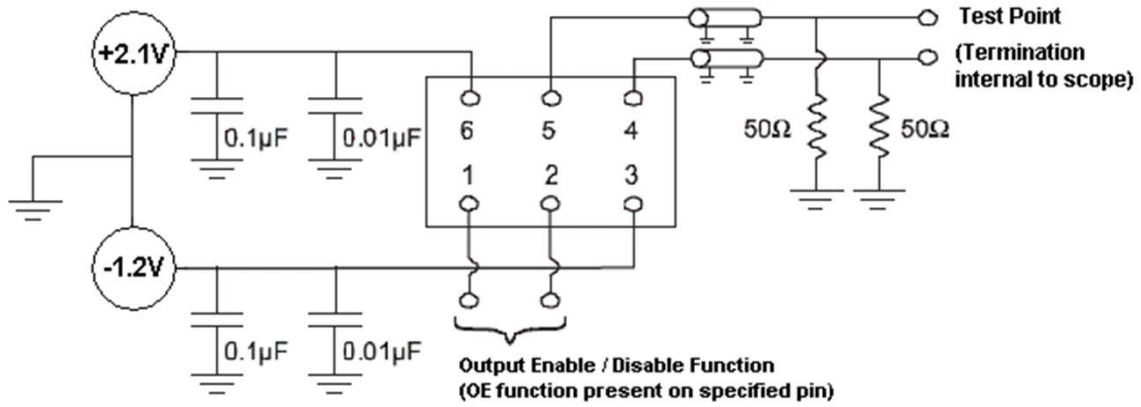

OUTPUT WAVEFORM

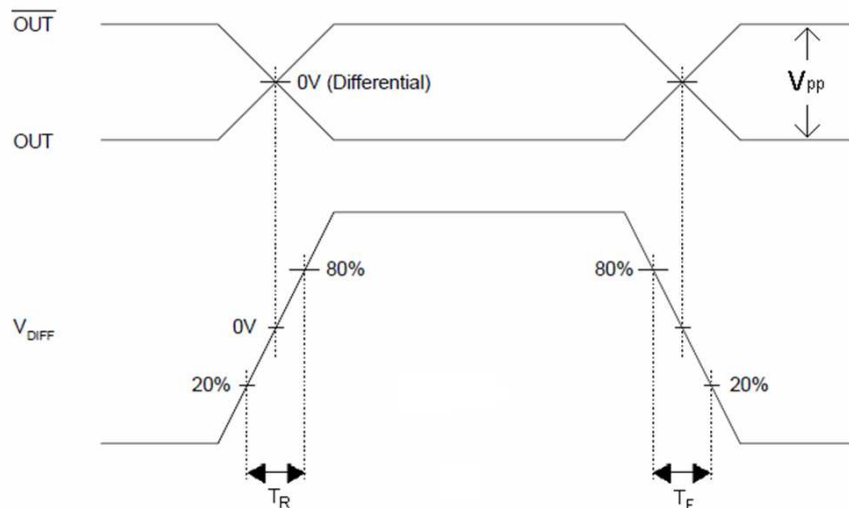
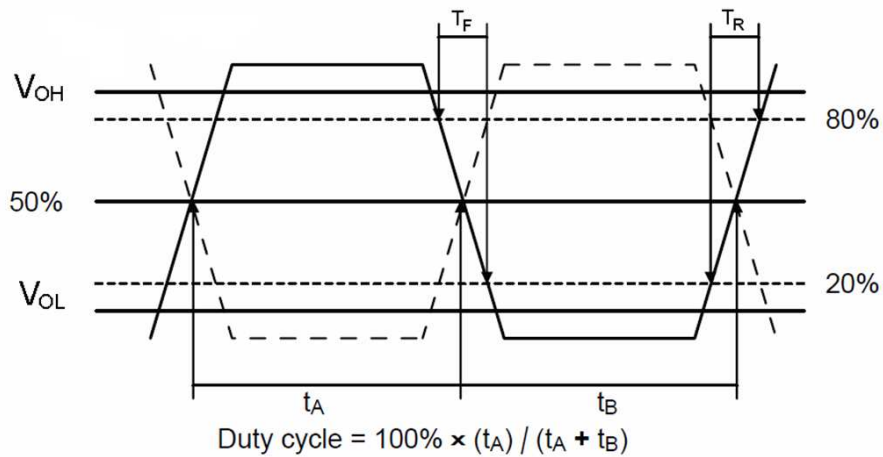

TYPE NX 5.0x3.2 SEAM SEALED CRYSTAL CLOCK OSCILLATOR

NX53K00002

VER. B 6-Jun-18

RELIABILITY SPECIFICATIONS

ENVIRONMENTAL:

- a) THERMAL SHOCK: MIL-STD-883, Method 1011, Condition A
- b) MOISTURE RESISTANCE: MIL-STD-883, Method 1004
- c) VIBRATION: MIL-STD-883, Method 2007, Condition A
- d) RESISTANCE TO SOLDERING HEAT: J-STD-020D Table 5-2 Pb-free devices (except 2 cycles max)
- e) HAZARDOUS SUBSTANCE: Pb - free and RoHS/ Green Compliant.

MECHANICAL:

- a) SHOCK: MIL-STD-883, Method 2002, Condition B
- b) SOLDERABILITY: JESD22-B102-D Method 2 (Preconditioning E)
- c) TERMINAL STRENGTH: MIL-STD-883, Method 2004, Test Condition D
- d) GROSS LEAK: MIL-STD-883, Method 1014, Condition C
- e) FINE LEAK: MIL-STD-883, Method 1014, Condition A2, $R1=2 \times 10^{-8}$ atm cc/s
- f) SOLVENT RESISTANCE: MIL-STD-202, Method 215

SUGGESTED IR REFLOW PROFILE

*As per IPC-JEDEC J-STD-020D

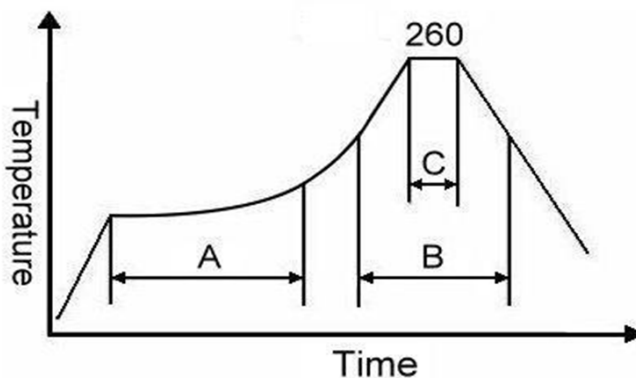

Note:

	Stage	Temperature	Time
A	Preheat	150~200°C	60~120 Sec
B	Primary Heat	217°C	60~150 Sec
C	Peak	260°C	10 Sec

TYPE NX 5.0x3.2 SEAM SEALED CRYSTAL CLOCK OSCILLATOR

NX53K00002

VER. B 6-Jun-18

MARKING

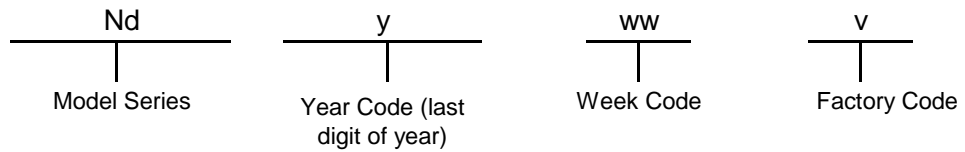
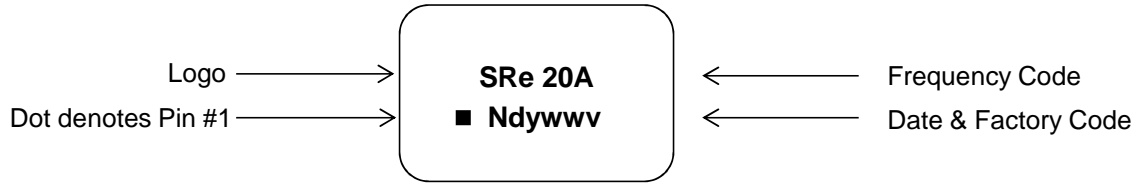

MECHANICAL DRAWINGS (Scale: None. Dimensions are in mm.)

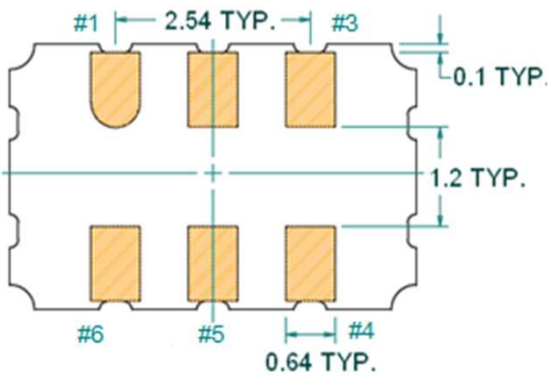
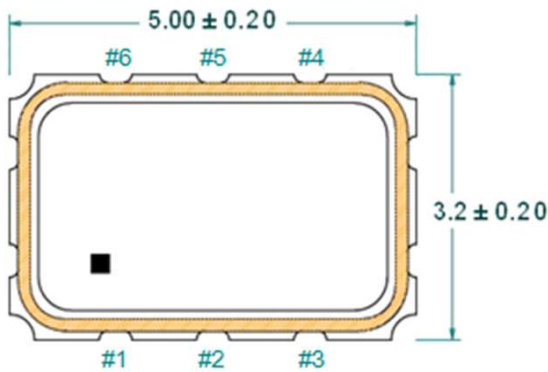

Bottom View

Recommended Land Pattern*

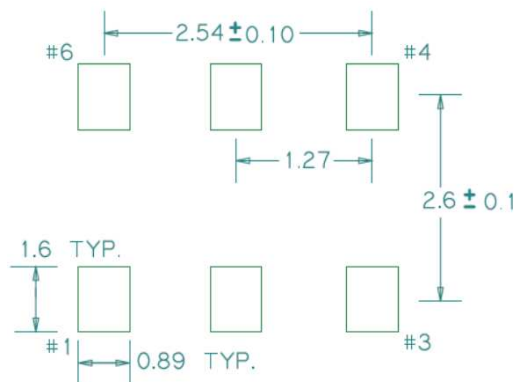

*External high-frequency power decoupling is recommended. (see test circuit for minimum recommendation). To ensure optimal performance, do not route traces beneath the package.

Pin	Function
1	OE
2	NC
3	Ground
4	Q
5	\bar{Q}
6	V _{CC}

TYPE NX 5.0x3.2 SEAM SEALED CRYSTAL CLOCK OSCILLATOR

NX53K00002

VER. B 6-Jun-18

PACKING

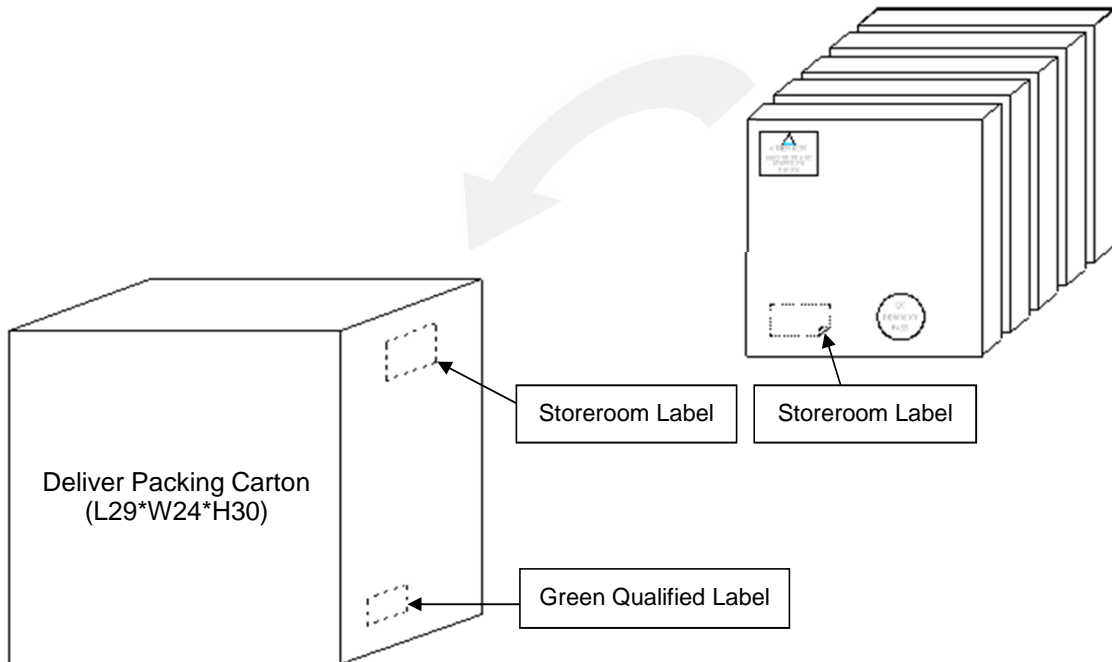
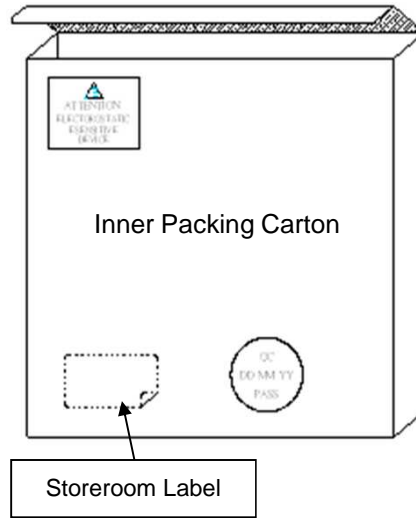
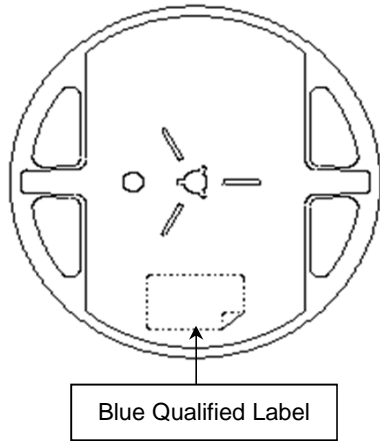
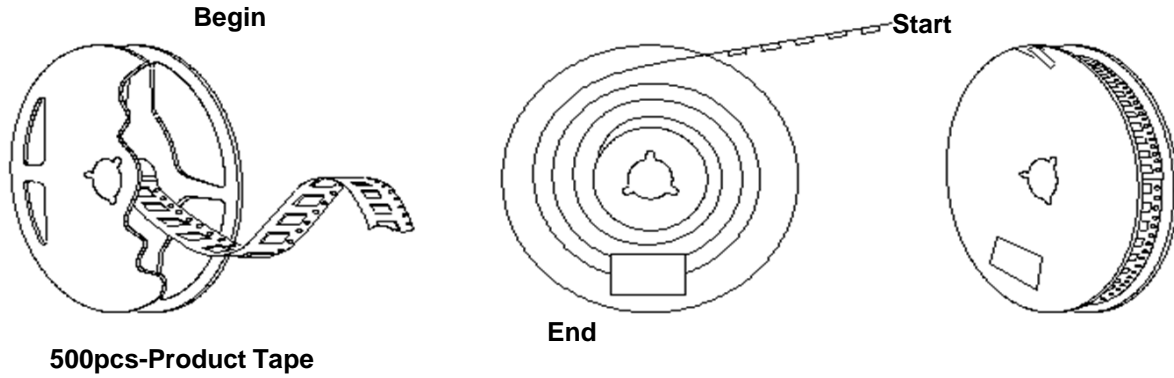

单击下面可查看定价，库存，交付和生命周期等信息

[>>Diodes Incorporated\(达达科技\(美台\)\)](#)