

Description

The AP4340S is an output voltage detector for Primary Side Control System. It is a low power loss solution. It detects the output voltage and provides a periodical signal when the output voltage is lower than a certain threshold. The periodical signal can be coupled by the transformer to the primary side and provided as an awakening signal for the main primary side controller. By fast response to secondary side voltage, the AP4340S can effectively improve the transient performance of Primary Side Control System.

AP4340S will enable a discharge circuit when it detects the output voltage is higher than a certain threshold.

The AP4340S is available in SOT23 package.

Features

- Fast Detector of Supply Voltages
- 33kHz Output Pulse
- No External Components
- Low Power Loss for Green Mode Applications
- **Totally Lead-free & Fully RoHS Compliant (Notes 1 & 2)**
- **Halogen and Antimony Free. "Green" Device (Note 3)**

Pin Assignments

(Top View)

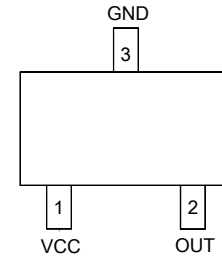

SOT23

Applications

- Adapters/Chargers for Cell/Cordless Phones, ADSL Modems, MP3 and Other Portable Apparatus
- Standby and Auxiliary Power Supplies

Notes: 1. No purposely added lead. Fully EU Directive 2002/95/EC (RoHS) & 2011/65/EU (RoHS 2) compliant.
 2. See http://www.diodes.com/quality/lead_free.html for more information about Diodes Incorporated's definitions of Halogen- and Antimony-free, "Green" and Lead-free.
 3. Halogen- and Antimony-free "Green" products are defined as those which contain <900ppm bromine, <900ppm chlorine (<1500ppm total Br + Cl) and <1000ppm antimony compounds.

Typical Applications Circuit

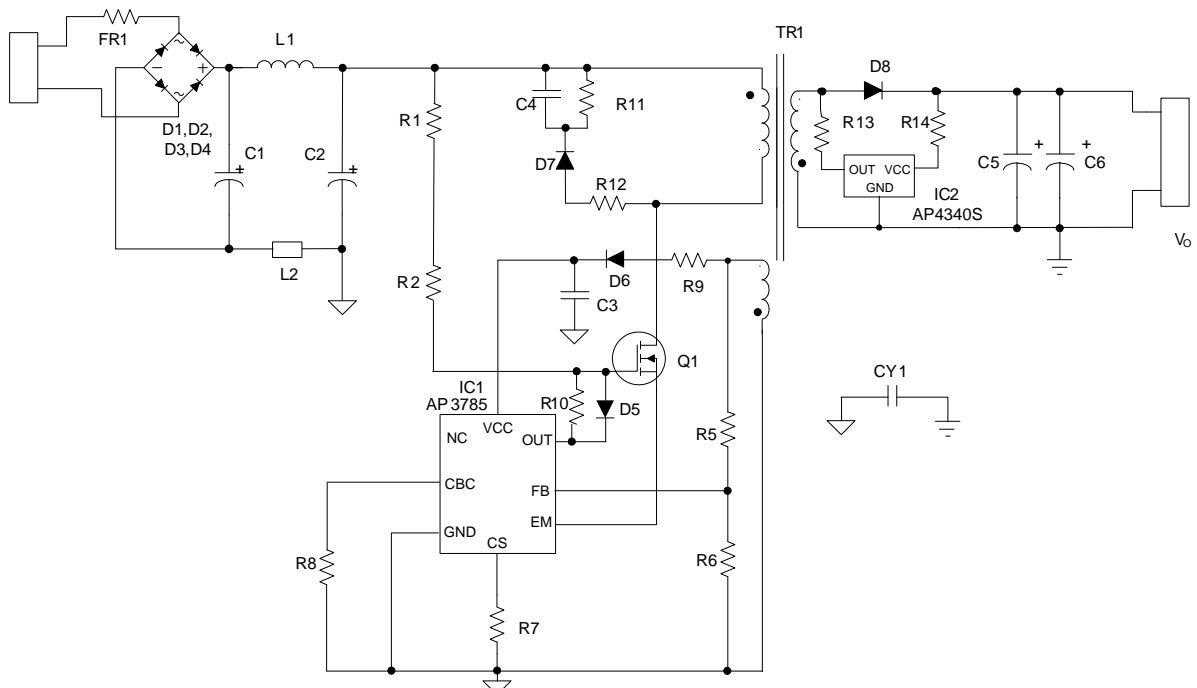

Pin Descriptions

Pin Number	Pin Name	Function
1	VCC	Power supply pin, connected with one end of the secondary winding and the output capacitor
2	OUT	Secondary detecting pin, connected with the other end of the secondary winding
3	GND	GND pin, connected with secondary side GND of the system

Functional Block Diagram

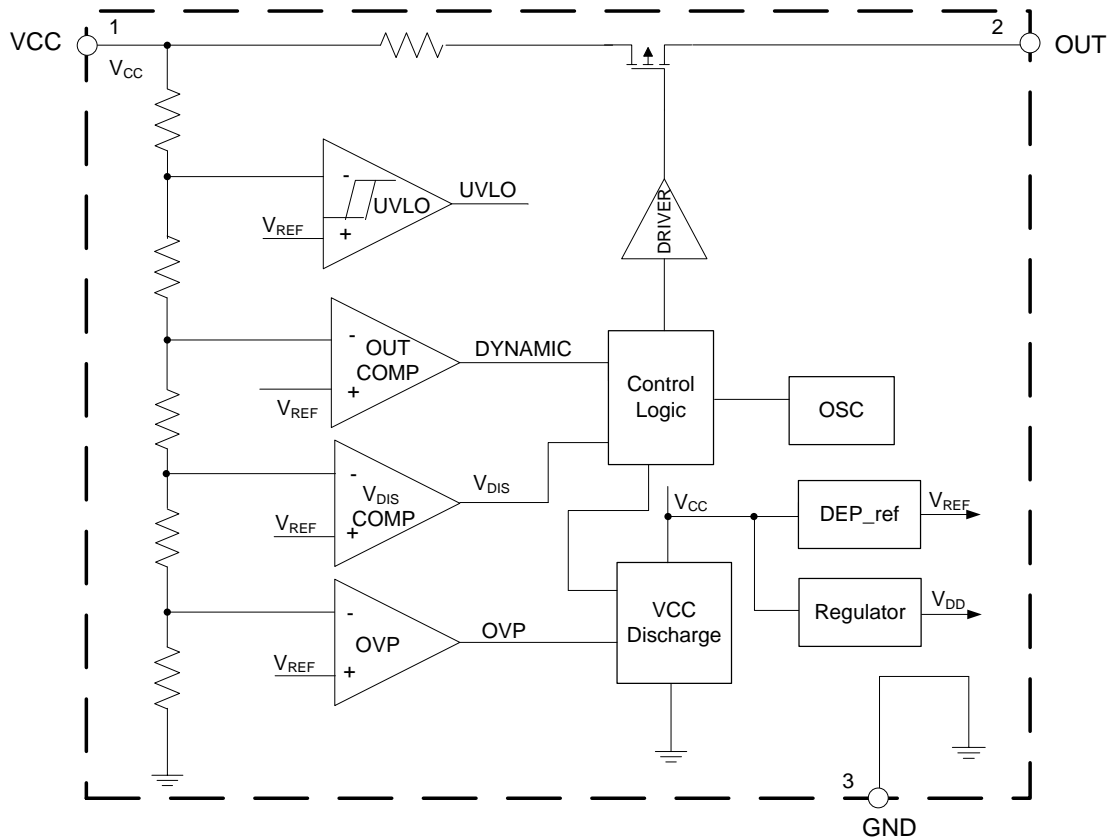

NEW PRODUCT

Absolute Maximum Ratings (Note 4)

Parameter	Rating	Unit
Supply Voltage	-0.3 to 9	V
Voltage at OUT	-40 to 7	V
Voltage from VCC to OUT	-7 to 49	V
Output Current at OUT	Internally limited	A
Power Dissipation at $T_A=+25^\circ\text{C}$	1.4	W
Operating Junction Temperature	+150	$^\circ\text{C}$
Storage Temperature	-65 to +150	$^\circ\text{C}$
Lead Temperature (Soldering, 10 sec)	+300	$^\circ\text{C}$
Thermal Resistance (Junction to Case)	140	$^\circ\text{C}/\text{W}$
Thermal Resistance (Junction to Ambient)	200	$^\circ\text{C}/\text{W}$

Note 4: Stresses greater than those listed under "Absolute Maximum Ratings" may cause permanent damage to the device. These are stress ratings only, and functional operation of the device at these or any other conditions beyond those indicated under "Recommended Operating Conditions" is not implied. Exposure to "Absolute Maximum Ratings" for extended periods may affect device reliability.

Recommended Operating Conditions

Symbol	Parameter	Min	Max	Unit
V_{CC}	Supply Voltage	4	5.5	V
T_A	Ambient Temperature Range	-40	+85	$^\circ\text{C}$

Electrical Characteristics (@ $V_{CC}=5\text{V}$, $T_A=+25^\circ\text{C}$, unless otherwise specified.)

Symbol	Parameter	Conditions	Min	Typ	Max	Unit
Supply Voltage (VCC Pin)						
V_{ON}	Power-on Voltage	–	2.5	3.1	4.6	V
I_{ST}	Startup Current	$V_{CC}=V_{ON}-0.2\text{V}$	–	5	10	μA
I_{OP}	Operating Current	OUT pin floating, $V_{CC}=5\text{V}$	10	15	20	μA
V_{OFF}	Power-off Voltage	–	2	2.8	4.2	V
V_{TRI}	Internal Trigger Voltage	–	4.65	4.73	4.8	V
Output Section/Oscillator Section						
DUTY	Duty Cycle	$V_{CC}=4.5\text{V}$	5	8.5	12	%
t_{OSC}	Oscillation Period	$V_{CC}=4.5\text{V}$	25	30	35	μs
I_{OUT}	Output Maximum Current	$V_{CC}=4.5\text{V}$	27	34	38	mA
V_{DIS}	Discharge Voltage	–	5.15	5.35	5.55	V
I_{DIS}	Discharge Current	–	1.5	3	4.5	mA
V_{OVP}	Overshoot Voltage for Discharge	–	5.6	5.78	5.95	V
I_{OVP}	Overshoot Current for Discharge	–	120	170	240	mA

Note 5: The system output voltage is 5V.

Operation Description

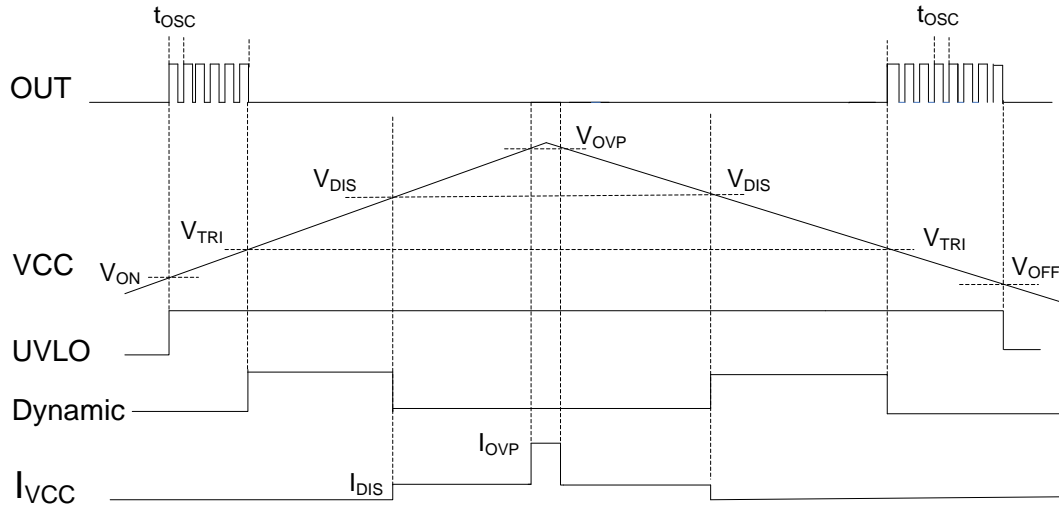

Figure 1. Typical Waveforms of AP4340S

When VCC voltage is beyond power-on voltage (V_{ON}), the AP4340S starts up. The OUT pin asserts a periodical pulse and oscillation period is t_{OSC} . When VCC voltage is lower than trigger voltage (V_{TRI}), the periodical pulse in OUT pin is discontinued. When VCC voltage exceeds discharge voltage (V_{DIS}), the discharge circuit will be enabled, a 1mA current will flow into VCC pin. When VCC voltage is higher than overshoot voltage (V_{OVP}), AP4340S will enable a discharge circuit until the VCC voltage falls below the overshoot voltage. At the same time, the periodical pulse in OUT pin will be disabled.

When the VCC voltage is below power-off voltage (V_{OFF}), the AP4340S will be shut down.

Performance Characteristics

Power-off Voltage vs. Ambient Temperature

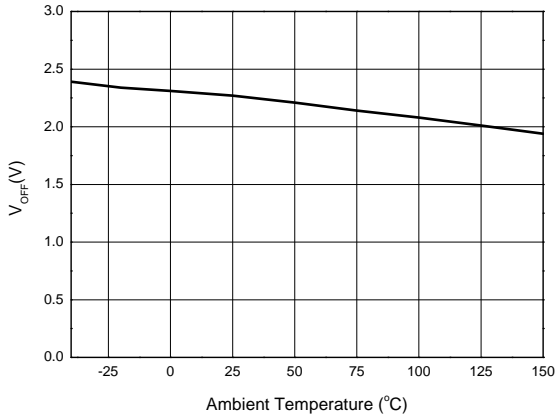

Power-on Voltage vs. Ambient Temperature

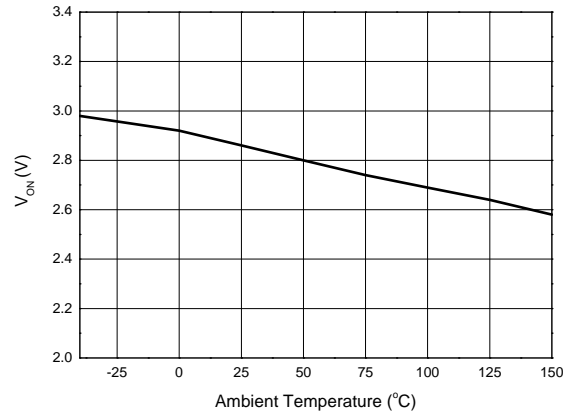

Trigger Voltage vs. Ambient Temperature

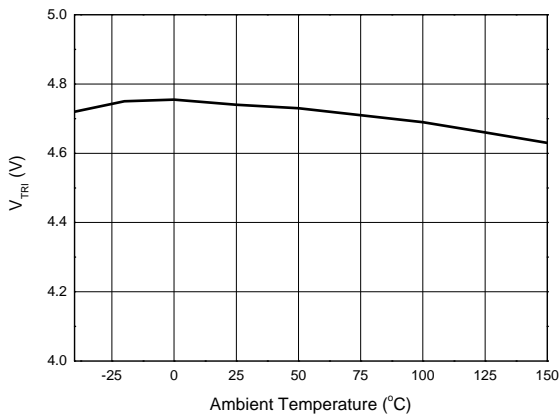

Output Current vs. Ambient Temperature

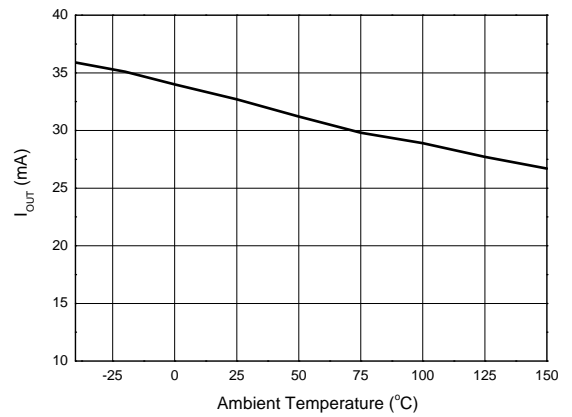

Duty Cycle vs. Ambient Temperature

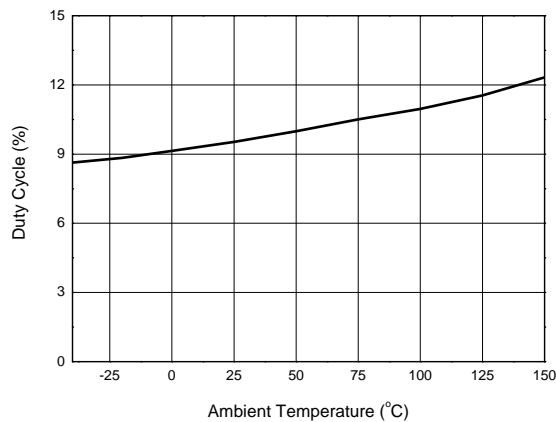

Oscillation Period vs. Ambient Temperature

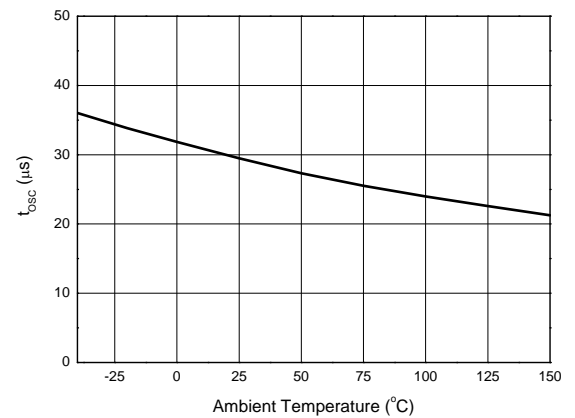

Performance Characteristics (Cont.)

Discharge Voltage vs. Ambient Temperature

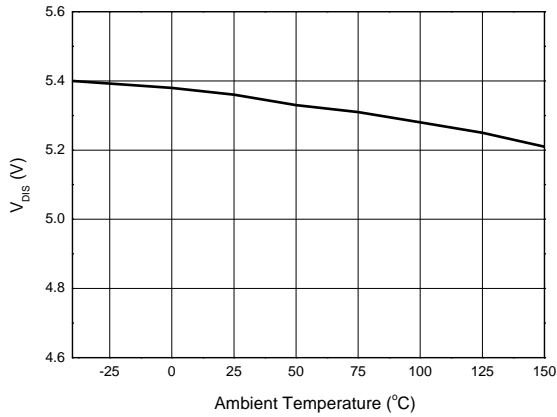

Discharge Current vs. Ambient Temperature

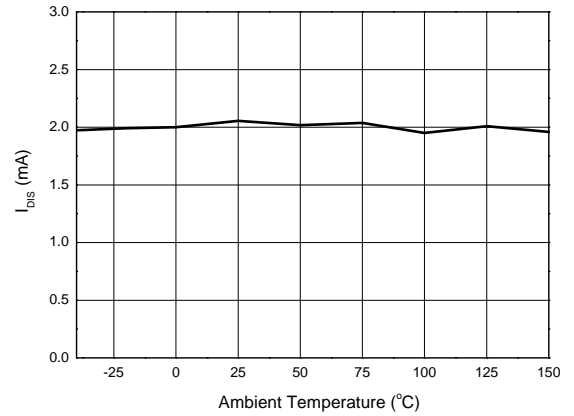

Overshoot Voltage for Discharge vs. Ambient Temperature

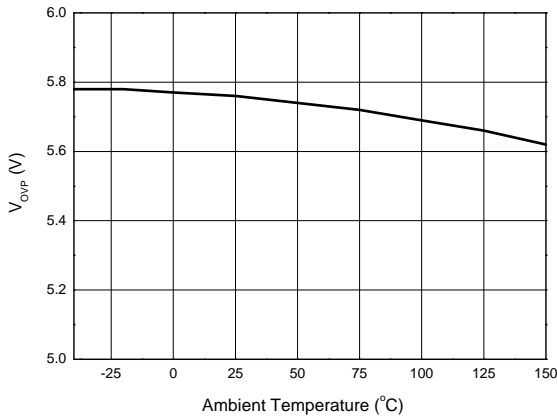

Overshoot Current for Discharge vs. Ambient Temperature

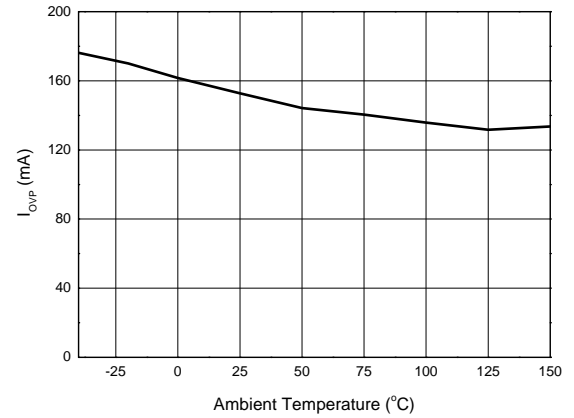

Operating Current vs. Ambient Temperature

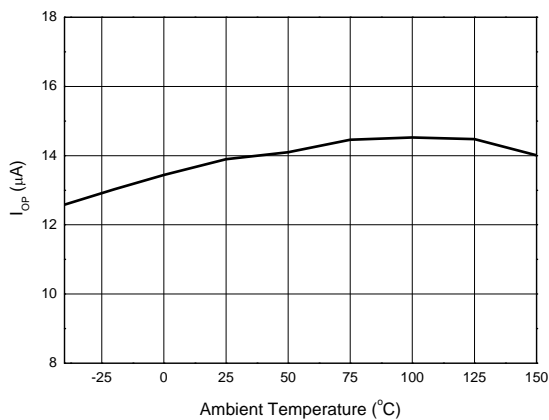

NEW PRODUCT

Ordering Information

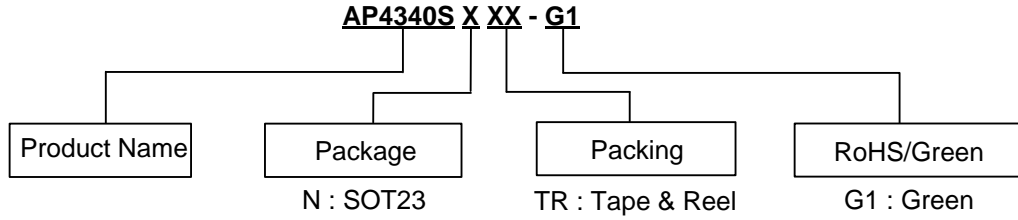

Package	Temperature Range	Part Number	Marking ID	Packing
SOT23	-40 to +150°C	AP4340SNTR-G1	GTA	3000/Tape & Reel

Marking Information

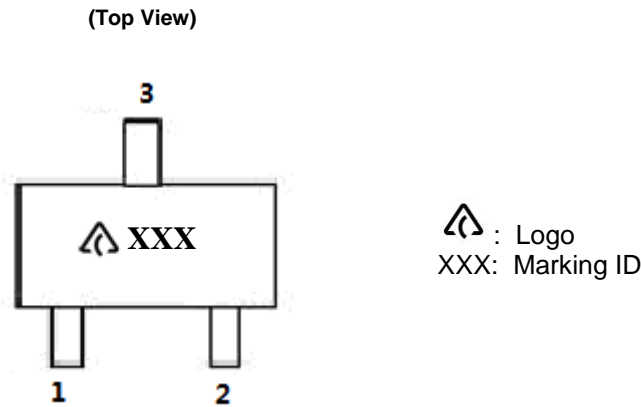

Package Outline Dimensions (All dimensions in mm(inch).)

(1) Package Type: SOT23

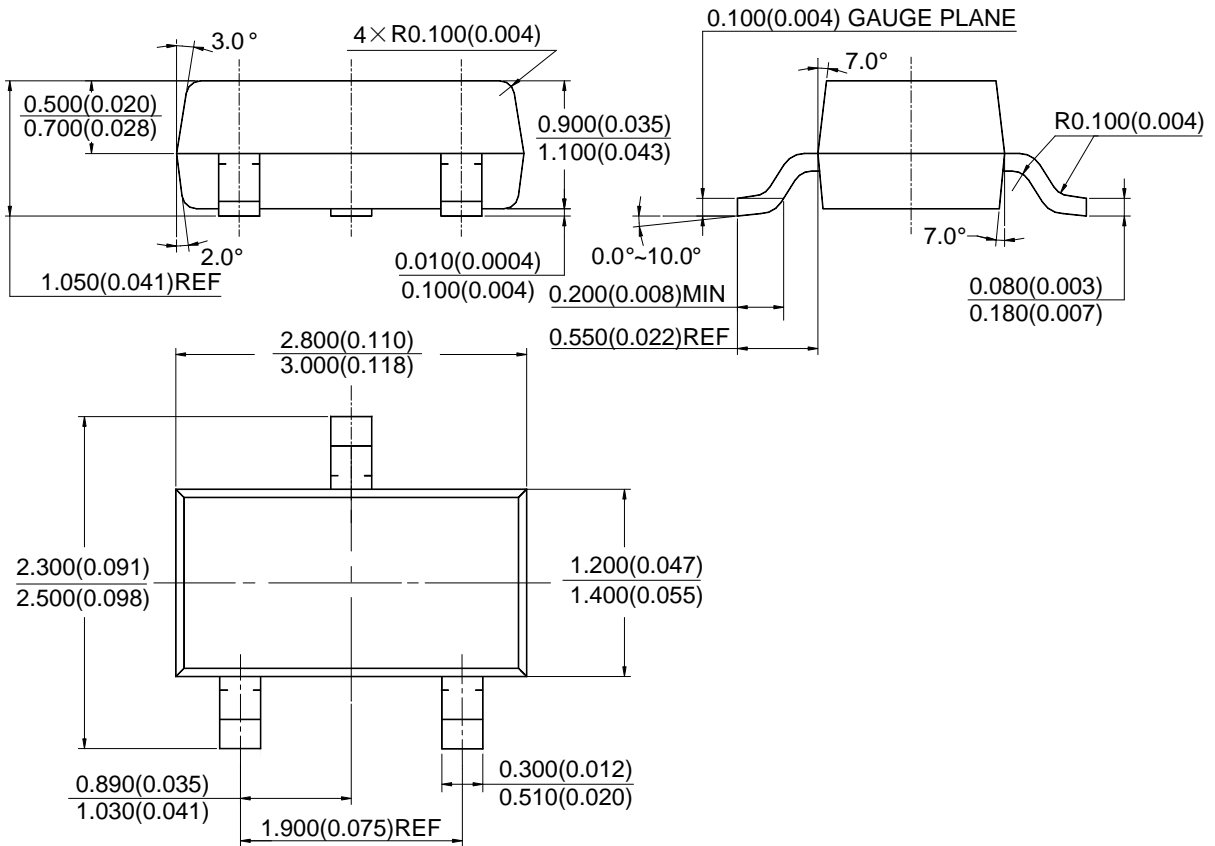

NEW PRODUCT

NEW PRODUCT

Suggested Pad Layout

(1) Package Type: SOT23

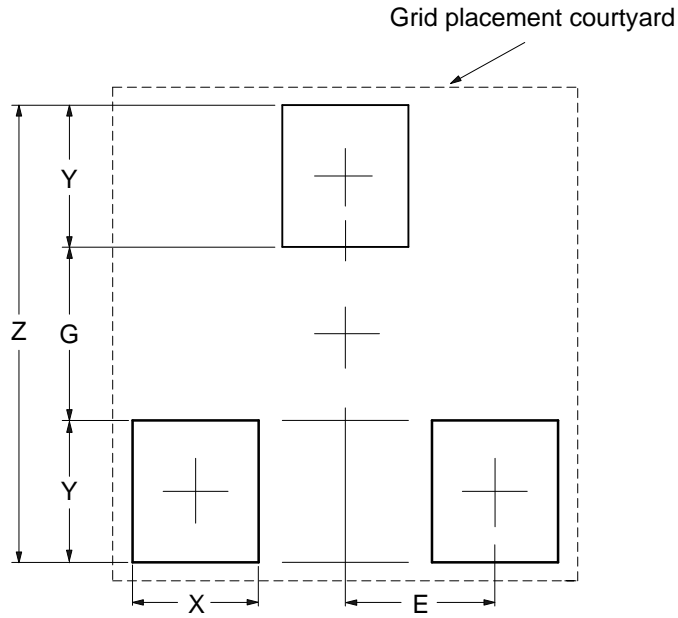

Dimensions	Z (mm)/(inch)	G (mm)/(inch)	X (mm)/(inch)	Y (mm)/(inch)	E (mm)/(inch)
Value	2.900/0.114	1.100/0.043	0.800/0.031	0.900/0.035	0.950/0.037

IMPORTANT NOTICE

DIODES INCORPORATED MAKES NO WARRANTY OF ANY KIND, EXPRESS OR IMPLIED, WITH REGARDS TO THIS DOCUMENT, INCLUDING, BUT NOT LIMITED TO, THE IMPLIED WARRANTIES OF MERCHANTABILITY AND FITNESS FOR A PARTICULAR PURPOSE (AND THEIR EQUIVALENTS UNDER THE LAWS OF ANY JURISDICTION).

Diodes Incorporated and its subsidiaries reserve the right to make modifications, enhancements, improvements, corrections or other changes without further notice to this document and any product described herein. Diodes Incorporated does not assume any liability arising out of the application or use of this document or any product described herein; neither does Diodes Incorporated convey any license under its patent or trademark rights, nor the rights of others. Any Customer or user of this document or products described herein in such applications shall assume all risks of such use and will agree to hold Diodes Incorporated and all the companies whose products are represented on Diodes Incorporated website, harmless against all damages.

Diodes Incorporated does not warrant or accept any liability whatsoever in respect of any products purchased through unauthorized sales channel. Should Customers purchase or use Diodes Incorporated products for any unintended or unauthorized application, Customers shall indemnify and hold Diodes Incorporated and its representatives harmless against all claims, damages, expenses, and attorney fees arising out of, directly or indirectly, any claim of personal injury or death associated with such unintended or unauthorized application.

Products described herein may be covered by one or more United States, international or foreign patents pending. Product names and markings noted herein may also be covered by one or more United States, international or foreign trademarks.

This document is written in English but may be translated into multiple languages for reference. Only the English version of this document is the final and determinative format released by Diodes Incorporated.

LIFE SUPPORT

Diodes Incorporated products are specifically not authorized for use as critical components in life support devices or systems without the express written approval of the Chief Executive Officer of Diodes Incorporated. As used herein:

A. Life support devices or systems are devices or systems which:

1. are intended to implant into the body, or
2. support or sustain life and whose failure to perform when properly used in accordance with instructions for use provided in the labeling can be reasonably expected to result in significant injury to the user.

B. A critical component is any component in a life support device or system whose failure to perform can be reasonably expected to cause the failure of the life support device or to affect its safety or effectiveness.

Customers represent that they have all necessary expertise in the safety and regulatory ramifications of their life support devices or systems, and acknowledge and agree that they are solely responsible for all legal, regulatory and safety-related requirements concerning their products and any use of Diodes Incorporated products in such safety-critical, life support devices or systems, notwithstanding any devices- or systems-related information or support that may be provided by Diodes Incorporated. Further, Customers must fully indemnify Diodes Incorporated and its representatives against any damages arising out of the use of Diodes Incorporated products in such safety-critical, life support devices or systems.

Copyright © 2015, Diodes Incorporated

www.diodes.com

单击下面可查看定价，库存，交付和生命周期等信息

[>>Diodes Incorporated\(达达科技\(美台\)\)](#)