

## Features

- $BV_{CEO} > 20V$
- $I_C = 6.5A$  Continuous Collector Current
- Very Low Saturation Voltage  $V_{CE(sat)} < 30mV @ 1A$
- $R_{CE(sat)} = 18m\Omega$
- High  $h_{FE}$  Min 260 @ 2A
- 1.5W Power Dissipation
- High Forward Blocking Voltage
- Complementary PNP Type: ZXTP19020DFF
- **Totally Lead-Free & Fully RoHS Compliant (Notes 1 and 2)**
- **Halogen and Antimony Free. "Green" Device (Note 3)**
- **Qualified to AEC-Q101 Standards for High Reliability**

## Description

Advanced process capability has been used to maximize the performance of this transistor. The SOT23F package is compatible with the industry standard SOT23 footprint but offers lower profile and higher dissipation for applications where power density is of utmost importance.

## Mechanical Data

- Case: SOT23F
- Case Material: Molded Plastic. "Green" Molding Compound  
UL Flammability Classification Rating 94V-0
- Moisture Sensitivity: Level 1 per J-STD-020
- Terminals: Finish - Matte Tin Plated Leads, Solderable per  
MIL-STD-202, Method 208 @3
- Weight: 0.012 grams (Approximate)

## Applications

- MOSFET and IGBT Gate Drivers
- LED Driver
- Strobe Flash
- Motor Drive
- Micro Buffers

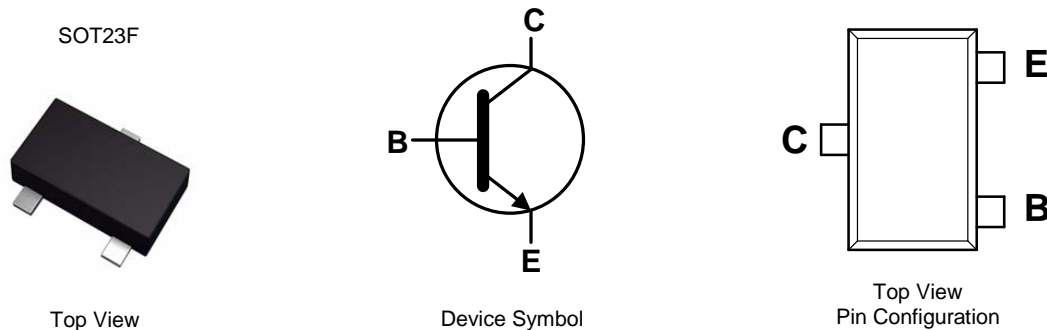

## Ordering Information (Note 4)

Part Number	Compliance	Marking	Reel size (inches)	Tape width (mm)	Quantity per reel
ZXTN19020DFFTA	AEC-Q101	1E3	7	8	3,000

- Notes:
1. No purposely added lead. Fully EU Directive 2002/95/EC (RoHS) & 2011/65/EU (RoHS 2) compliant.
  2. See [http://www.diodes.com/quality/lead\\_free.html](http://www.diodes.com/quality/lead_free.html) for more information about Diodes Incorporated's definitions of Halogen- and Antimony-free, "Green" and Lead-free.
  3. Halogen- and Antimony-free "Green" products are defined as those which contain <900ppm bromine, <900ppm chlorine (<1500ppm total Br + Cl) and <1000ppm antimony compounds.
  4. For packaging details, go to our website at <http://www.diodes.com/products/packages.html>.

## Marking Information

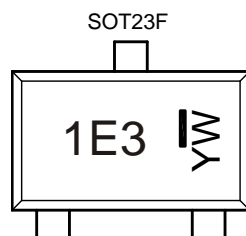

- 1E3 = Product Type Marking Code  
 YW = Date Code Marking  
 Y = Year : 0~9  
 W = Week : A~Z : 1~26  
 a~z : 27~52  
 z represents 52 & 53 week

**Absolute Maximum Ratings** (@T<sub>A</sub> = +25°C, unless otherwise specified.)

Characteristic	Symbol	Value	Unit
Collector-Base Voltage	V <sub>CB0</sub>	70	V
Collector-Emitter Voltage (Forward Blocking)	V <sub>CEx</sub>	70	V
Collector-Emitter Voltage	V <sub>CE0</sub>	20	V
Emitter-Collector Voltage (Reverse Blocking)	V <sub>EC0</sub>	4.5	V
Emitter-Base Voltage	V <sub>EBO</sub>	7	V
Continuous Collector Current	I <sub>C</sub>	6.5	A
Peak Pulse Current	I <sub>CM</sub>	20	A
Base Current	I <sub>B</sub>	1	A

**Thermal Characteristics** (@T<sub>A</sub> = +25°C, unless otherwise specified.)

Characteristic	Symbol	Value	Unit
Power Dissipation Linear Derating Factor	P <sub>D</sub>	0.84	W mW/°C
		6.72	
		1.34	
		10.72	
		1.50	
Thermal Resistance, Junction to Ambient	R <sub>θJA</sub>	12.0	°C/W
		2.0	
		16.0	
		149	
Thermal Resistance, Junction to Ambient	R <sub>θJA</sub>	93	°C/W
		83	
		60	
Thermal Resistance, Junction to Lead	R <sub>θJL</sub>	43.77	°C/W
Operating and Storage Temperature Range	T <sub>J</sub> , T <sub>STG</sub>	-55 to +150	°C

**ESD Ratings** (Note 10)

Characteristic	Symbol	Value	Unit	JEDEC Class
Electrostatic Discharge - Human Body Model	ESD HBM	4,000	V	3A
Electrostatic Discharge - Machine Model	ESD MM	400	V	C

- Notes:
- For a device mounted with the exposed collector pad on 15mm x 15mm 1oz copper that is on a single-sided 1.6mm FR-4 PCB; device is measured under still air conditions whilst operating in a steady-state.
  - Same as Note 5, except the device is mounted on 25mm x 25mm 2oz copper.
  - Same as Note 5, except the device is mounted on 50mm x 50mm 2oz copper.
  - Same as Note 7, whilst measured at t < 5 seconds.
  - Thermal resistance from junction to solder-point (at the end of the collector lead).
  - Refer to JEDEC specification JESD22-A114 and JESD22-A115.

**Thermal Characteristics and Derating Information**

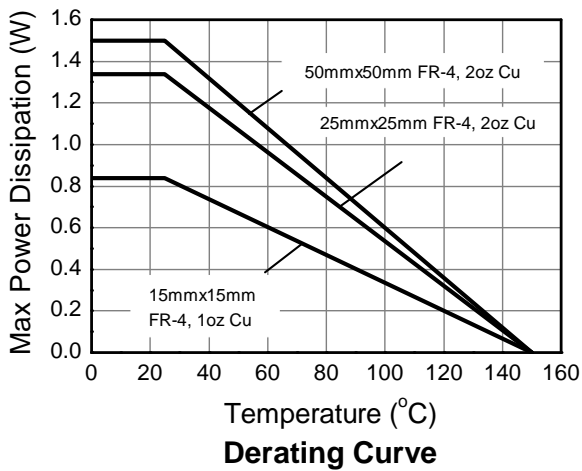
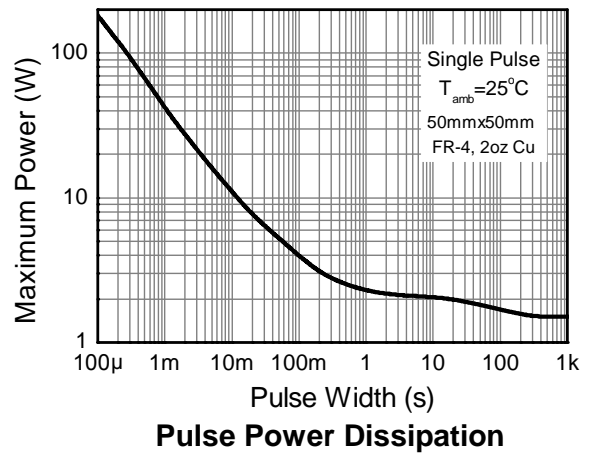
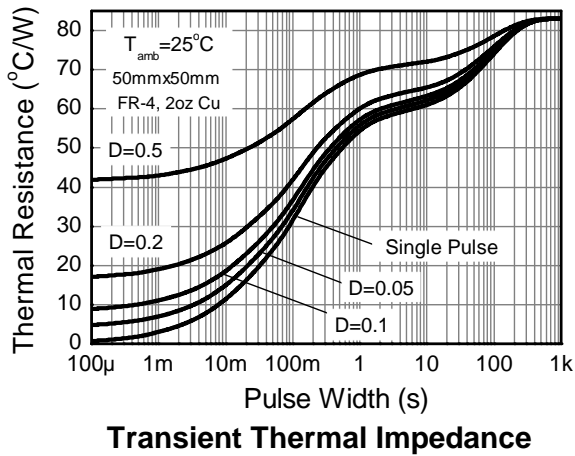
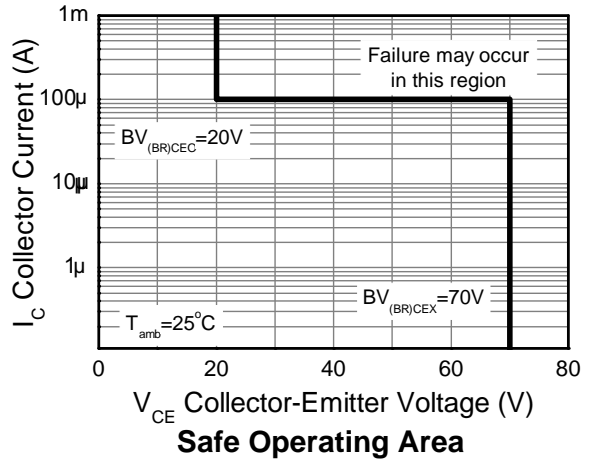
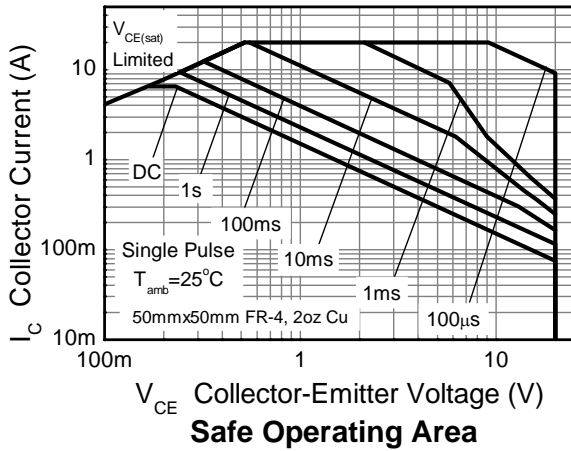

**Electrical Characteristics** (@ $T_A = +25^\circ\text{C}$ , unless otherwise specified.)

Characteristic	Symbol	Min	Typ	Max	Unit	Test Condition
<b>OFF CHARACTERISTICS</b>						
Collector-Base Breakdown Voltage	$BV_{CBO}$	70	100	—	V	$I_C = 100\mu\text{A}$
Collector-Emitter Breakdown Voltage (Forward Blocking)	$BV_{CEX}$	70	100	—	V	$I_C = 100\mu\text{A}$ ; $R_{BC} < 1\text{k}\Omega$ or $-1\text{V} < V_{BE} < 0.25\text{V}$
Collector-Emitter Breakdown Voltage (Base Open) (Note 11)	$BV_{CEO}$	20	30	—	V	$I_C = 10\text{mA}$
Emitter-Base Breakdown Voltage	$BV_{EBO}$	7	8.4	—	V	$I_E = 100\mu\text{A}$
Emitter-Collector Breakdown Voltage (Reverse Blocking)	$BV_{ECX}$	6	8.4	—	V	$I_E = 100\mu\text{A}$ ; $R_{BC} \leq 1\text{k}\Omega$ or $-0.25\text{V} < V_{BC} < 0.25\text{V}$
Emitter-Collector Breakdown Voltage (Base Open)	$BV_{ECO}$	4.5	5.7	—	V	$I_E = 100\mu\text{A}$
Collector-Base Cut-Off Current	$I_{CBO}$	—	<1	50 20	nA $\mu\text{A}$	$V_{CB} = 56\text{V}$ $V_{CB} = 56\text{V}$ , $T_A = +100^\circ\text{C}$
Collector-Emitter Cut-Off Current	$I_{CEX}$	—	—	100	nA	$V_{CE} = 56\text{V}$ ; $R_{BE} \leq 1\text{k}\Omega$ or $-1\text{V} < V_{BE} < 0.25\text{V}$
Emitter-Base Cut-Off Current	$I_{EBO}$	—	<1	50	nA	$V_{EB} = 5.6\text{V}$
<b>ON CHARACTERISTICS (Note 11)</b>						
Static Forward Current Transfer Ratio	$h_{FE}$	300	450	900	—	$I_C = 0.1\text{A}$ , $V_{CE} = 2\text{V}$
		260	420	—		
		160	270	—		
		50	80	—		
Collector-Emitter Saturation Voltage	$V_{CE(sat)}$	—	25	30	mV	$I_C = 1\text{A}$ , $I_B = 100\text{mA}$
		—	45	65		
		—	70	95		
		—	55	75		
		—	140	190		
Base-Emitter Saturation Voltage	$V_{BE(sat)}$	—	940	1050	mV	$I_C = 6.5\text{A}$ , $I_B = 180\text{mA}$
Base-Emitter On Voltage	$V_{BE(on)}$	—	830	950	mV	$I_C = 6.5\text{A}$ , $V_{CE} = 2\text{V}$
<b>SMALL SIGNAL CHARACTERISTICS</b>						
Transition Frequency	$f_T$	—	160	—	MHz	$I_C = 50\text{mA}$ , $V_{CE} = 5\text{V}$ , $f = 50\text{MHz}$
Input Capacitance	$C_{ibo}$	—	297	—	pF	$V_{EB} = 0.5\text{V}$ , $f = 1\text{MHz}$
Output Capacitance	$C_{obo}$	—	32.6	40	pF	$V_{CB} = 10\text{V}$ , $f = 1\text{MHz}$
Delay Time	$t_d$	—	129	—	ns	$V_{CC} = 10\text{V}$ , $I_C = 1\text{A}$ , $I_{B1} = -I_{B2} = 10\text{mA}$
Rise Time	$t_r$	—	96	—	ns	
Storage Time	$t_s$	—	398	—	ns	
Fall Time	$t_f$	—	90	—	ns	

Note: 11. Measured under pulsed conditions. Pulse width  $\leq 300\mu\text{s}$ . Duty cycle  $\leq 2\%$ .

**Typical Electrical Characteristics** (@ $T_A = +25^\circ\text{C}$ , unless otherwise specified.)

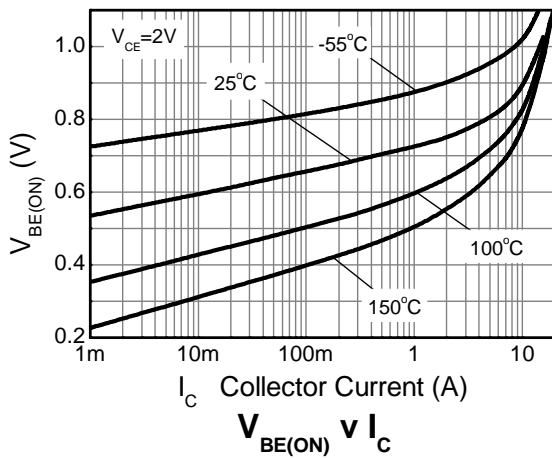
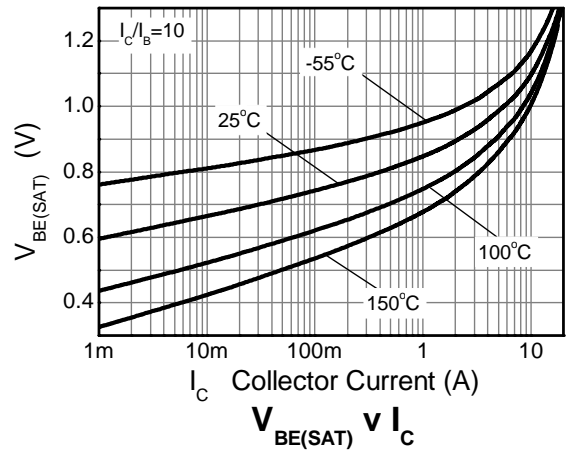
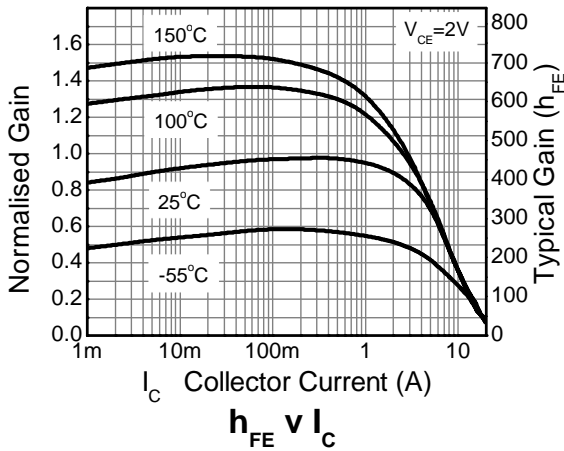
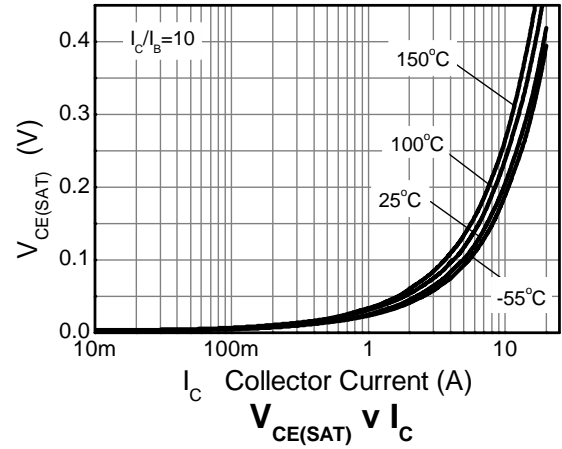
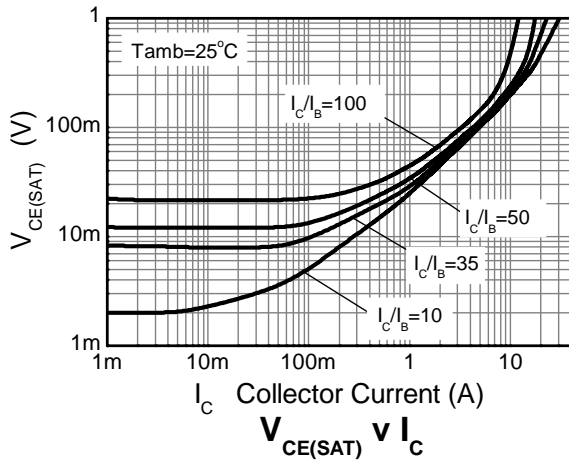

**Package Outline Dimensions**

Please see <http://www.diodes.com/package-outlines.html> for the latest version.

**SOT23F**

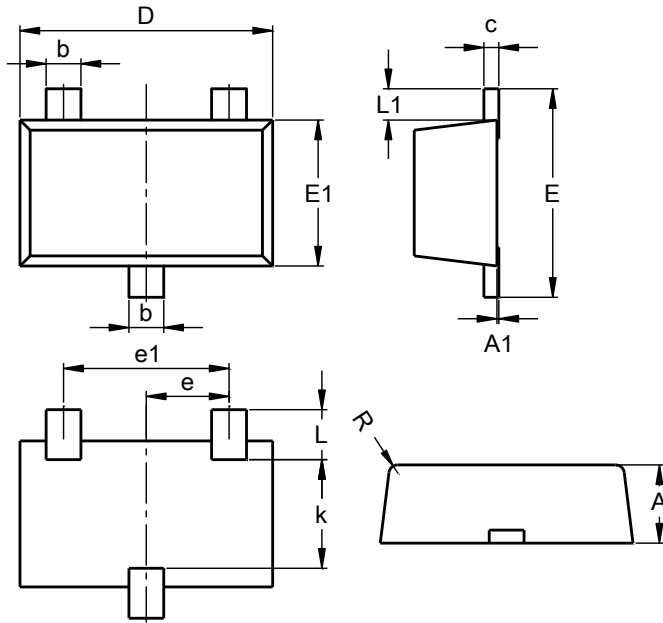

SOT23F			
Dim	Min	Max	Typ
A	0.80	1.00	0.90
A1	0.00	0.10	0.01
b	0.35	0.50	0.44
c	0.10	0.20	0.16
D	2.80	3.00	2.90
e	0.95 REF		
e1	1.90 REF		
E	2.30	2.50	2.40
E1	1.50	1.70	1.65
k	1.20	-	-
L	0.30	0.65	0.50
L1	0.30	0.50	0.40
R	0.05	0.15	-
All Dimensions in mm			

**Suggested Pad Layout**

Please see <http://www.diodes.com/package-outlines.html> for the latest version.

**SOT23F**

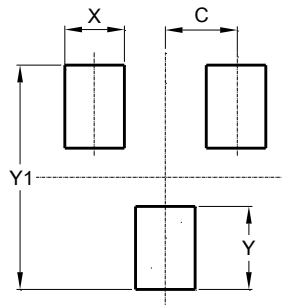

Dimensions	Value (in mm)
C	0.95
X	0.80
Y	1.110
Y1	3.000

**IMPORTANT NOTICE**

DIODES INCORPORATED MAKES NO WARRANTY OF ANY KIND, EXPRESS OR IMPLIED, WITH REGARDS TO THIS DOCUMENT, INCLUDING, BUT NOT LIMITED TO, THE IMPLIED WARRANTIES OF MERCHANTABILITY AND FITNESS FOR A PARTICULAR PURPOSE (AND THEIR EQUIVALENTS UNDER THE LAWS OF ANY JURISDICTION).

Diodes Incorporated and its subsidiaries reserve the right to make modifications, enhancements, improvements, corrections or other changes without further notice to this document and any product described herein. Diodes Incorporated does not assume any liability arising out of the application or use of this document or any product described herein; neither does Diodes Incorporated convey any license under its patent or trademark rights, nor the rights of others. Any Customer or user of this document or products described herein in such applications shall assume all risks of such use and will agree to hold Diodes Incorporated and all the companies whose products are represented on Diodes Incorporated website, harmless against all damages.

Diodes Incorporated does not warrant or accept any liability whatsoever in respect of any products purchased through unauthorized sales channel. Should Customers purchase or use Diodes Incorporated products for any unintended or unauthorized application, Customers shall indemnify and hold Diodes Incorporated and its representatives harmless against all claims, damages, expenses, and attorney fees arising out of, directly or indirectly, any claim of personal injury or death associated with such unintended or unauthorized application.

Products described herein may be covered by one or more United States, international or foreign patents pending. Product names and markings noted herein may also be covered by one or more United States, international or foreign trademarks.

**LIFE SUPPORT**

Diodes Incorporated products are specifically not authorized for use as critical components in life support devices or systems without the express written approval of the Chief Executive Officer of Diodes Incorporated. As used herein:

A. Life support devices or systems are devices or systems which:

1. are intended to implant into the body, or
2. support or sustain life and whose failure to perform when properly used in accordance with instructions for use provided in the labeling can be reasonably expected to result in significant injury to the user.

B. A critical component is any component in a life support device or system whose failure to perform can be reasonably expected to cause the failure of the life support device or to affect its safety or effectiveness.

Customers represent that they have all necessary expertise in the safety and regulatory ramifications of their life support devices or systems, and acknowledge and agree that they are solely responsible for all legal, regulatory and safety-related requirements concerning their products and any use of Diodes Incorporated products in such safety-critical, life support devices or systems, notwithstanding any devices- or systems-related information or support that may be provided by Diodes Incorporated. Further, Customers must fully indemnify Diodes Incorporated and its representatives against any damages arising out of the use of Diodes Incorporated products in such safety-critical, life support devices or systems.

Copyright © 2016, Diodes Incorporated

[www.diodes.com](http://www.diodes.com)

单击下面可查看定价，库存，交付和生命周期等信息

[>>Diodes Incorporated\(达达科技\(美台\)\)](#)