

Features

- Low Forward Voltage Drop
- Guard Ring Die Construction for Transient Protection
- Ideal for Low Logic Level Applications
- Low Capacitance
- **Lead, Halogen and Antimony Free, RoHS Compliant "Green" Device (Notes 2 and 3)**

Mechanical Data

- Case: SOD-323
- Case Material: Molded Plastic. UL Flammability Classification Rating 94V-0
- Moisture Sensitivity: Level 1 per J-STD-020D
- Leads: Solderable per MIL-STD-202, Method 208
- Lead Free Plating (Matte Tin Finish annealed over Alloy 42 leadframe).
- Polarity: Cathode Band
- Marking Information: See Page 3
- Ordering Information: See Page 3
- Weight: 0.004 grams (approximate)



Top View

Maximum Ratings @ $T_A = 25^\circ\text{C}$ unless otherwise specified

Characteristic	Symbol	Value	Unit
Peak Repetitive Reverse Voltage	V_{RRM}	40	V
Working Peak Reverse Voltage	V_{RWM}		
DC Blocking Voltage	V_R		
RMS Reverse Voltage	$V_{R(RMS)}$	28	V
Maximum (Peak) Forward Current	I_{FM}	30	mA
Non-Repetitive Peak Forward Surge Current @8.3ms Single half sine-wave superimposed on rated load (JEDEC method)	I_{FSM}	200	mA

Thermal Characteristics

Characteristic	Symbol	Value	Unit
Power Dissipation	P_D	160	mW
Thermal Resistance, Junction to Ambient Air	$R_{\theta JA}$	625	$^\circ\text{C}/\text{W}$
Operating and Storage Temperature Range	T_J, T_{STG}	-40 to +125	$^\circ\text{C}$

Electrical Characteristics @ $T_A = 25^\circ\text{C}$ unless otherwise specified

Characteristic	Symbol	Min	Typ	Max	Unit	Test Condition
Reverse Breakdown Voltage (Note 1)	$V_{(BR)R}$	40	—	—	V	$I_R = 10\mu\text{A}$
Forward Voltage Drop	V_F	—	290	370	mV	$I_F = 1\text{mA}$
Leakage Current (Note 1)	I_R	—	0.20	0.5	μA	$V_R = 30\text{V}$
Total Capacitance	C_T	—	2	—	pF	$V_R = 1\text{V}$ $f = 1.0\text{MHz}$

- Notes:
1. Short duration pulse test used to minimize self-heating effect.
 2. No purposefully added lead. Halogen and Antimony Free.
 3. Product manufactured with Data Code V9 (week 33, 2008) and newer are built with Green Molding Compound. Products manufactured prior to Date Code V9 are built with Non-Green Molding Compound and may contain Halogens or Sb_2O_3 Fire Retardants.

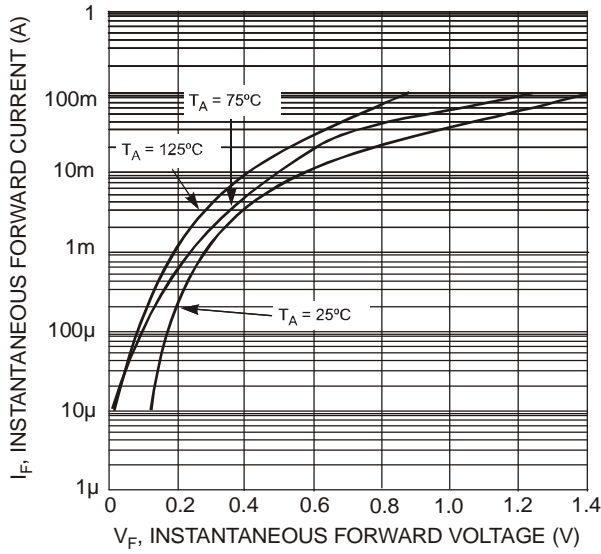

Fig. 1 Typical Forward Characteristics

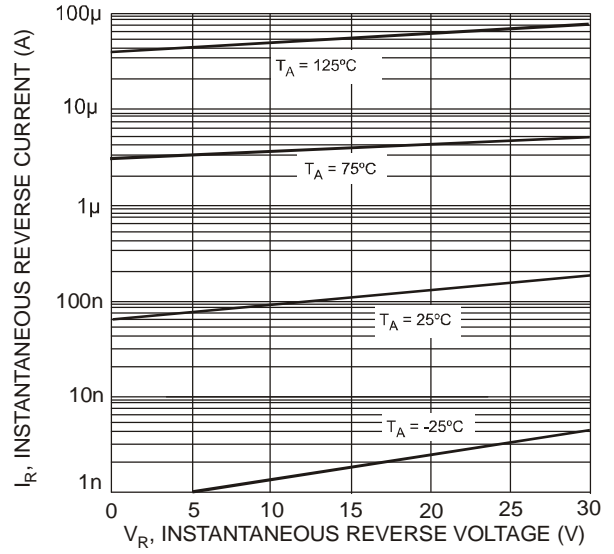

Fig. 2 Typical Reverse Characteristics

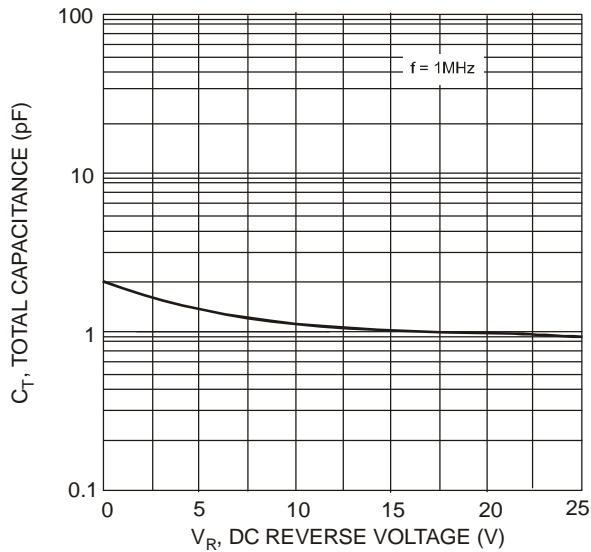

Fig. 3 Total Capacitance vs. Reverse Voltage

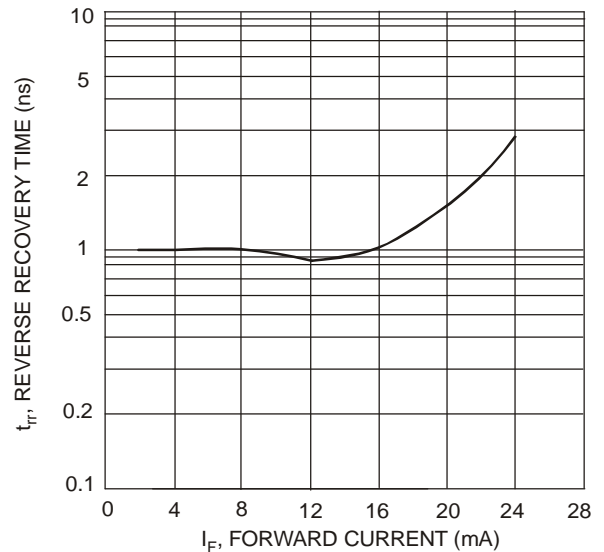

Fig. 4 Typical Reverse Recovery Time Characteristics

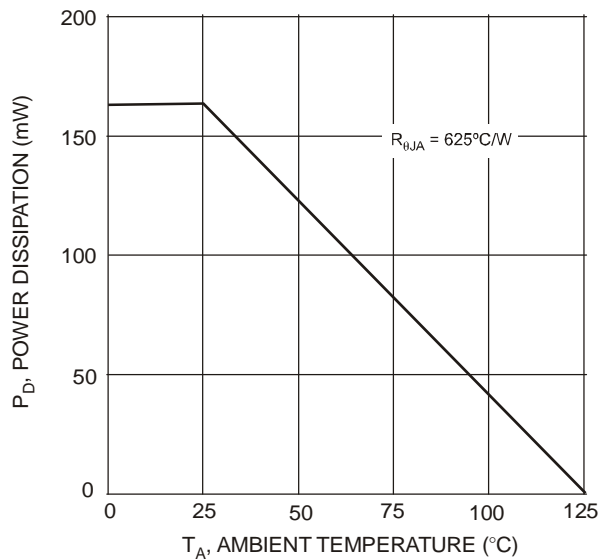

Fig. 5 Power Derating Curve

Ordering Information (Note 4)

Device	Packaging	Shipping
SDMK0340L-7-F	SOD-323	3000/Tape & Reel

Notes: 4. For packaging details, go to our website at <http://www.diodes.com/datasheets/ap02007.pdf>.

Marking Information



SR = Product Type Marking Code

Package Outline Dimensions

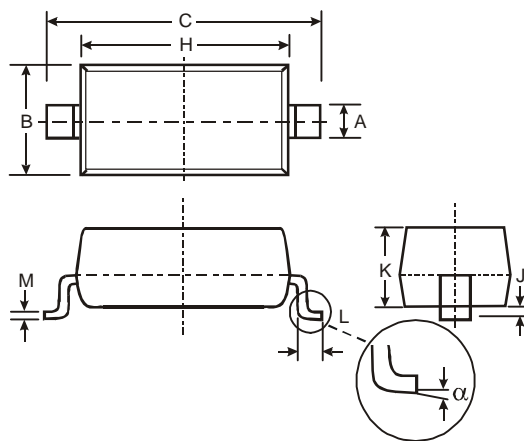

SOD-323		
Dim	Min	Max
A	0.25	0.35
B	1.20	1.40
C	2.30	2.70
H	1.60	1.80
J	0.00	0.10
K	1.0	1.1
L	0.20	0.40
M	0.10	0.15
α	0°	8°
All Dimensions in mm		

Suggested Pad Layout

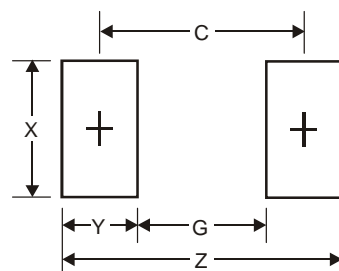

Dimensions	Value (in mm)
Z	3.75
G	1.05
X	0.65
Y	1.35
C	2.40

IMPORTANT NOTICE

Diodes Incorporated and its subsidiaries reserve the right to make modifications, enhancements, improvements, corrections or other changes without further notice to any product herein. Diodes Incorporated does not assume any liability arising out of the application or use of any product described herein; neither does it convey any license under its patent rights, nor the rights of others. The user of products in such applications shall assume all risks of such use and will agree to hold Diodes Incorporated and all the companies whose products are represented on our website, harmless against all damages.

LIFE SUPPORT

Diodes Incorporated products are not authorized for use as critical components in life support devices or systems without the expressed written approval of the President of Diodes Incorporated.

单击下面可查看定价，库存，交付和生命周期等信息

[>>Diodes Incorporated\(达达科技\(美台\)\)](#)