

### Features

- Glass Passivated Die Construction
- Fast Recovery Time for High Efficiency
- Low Forward Voltage Drop and High Current Capability
- Surge Overload Rating to 100A Peak
- Ideally Suited for Automatic Assembly
- Plastic Material: UL Flammability Classification Rating 94V-0

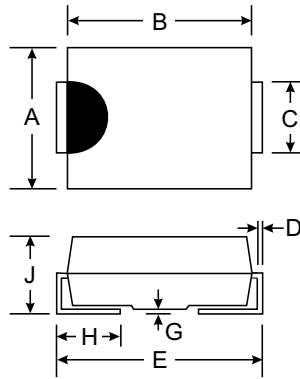

| Dim                  | SMB  |      | SMC  |      |
|----------------------|------|------|------|------|
|                      | Min  | Max  | Min  | Max  |
| A                    | 3.30 | 3.94 | 5.59 | 6.22 |
| B                    | 4.06 | 4.57 | 6.60 | 7.11 |
| C                    | 1.96 | 2.21 | 2.75 | 3.18 |
| D                    | 0.15 | 0.31 | 0.15 | 0.31 |
| E                    | 5.00 | 5.59 | 7.75 | 8.13 |
| G                    | 0.10 | 0.20 | 0.10 | 0.20 |
| H                    | 0.76 | 1.52 | 0.76 | 1.52 |
| J                    | 2.00 | 2.62 | 2.00 | 2.62 |
| All Dimensions in mm |      |      |      |      |

### Mechanical Data

- Case: Molded Plastic
- Terminals: Solder Plated Terminal - Solderable per MIL-STD-202, Method 208
- Polarity: Cathode Band or Cathode Notch
- Marking: Type Number
- SMB Weight: 0.09 grams (approx.)
- SMC Weight: 0.20 grams (approx.)

AB, BB, DB, GB, JB, KB, MB Suffix Designates SMB Package  
A, B, D, G, J, K, M Suffix Designates SMC Package

### Maximum Ratings and Electrical Characteristics @ T<sub>A</sub> = 25°C unless otherwise specified

Single phase, half wave, 60Hz, resistive or inductive load.  
For capacitive load, derate current by 20%.

| Characteristic                                                                                                        | Symbol                            | RS3 A/AB    | RS3 B/BB | RS3 D/DB | RS3 G/GB | RS3 J/JB | RS3 K/KB | RS3 M/MB | Unit |
|-----------------------------------------------------------------------------------------------------------------------|-----------------------------------|-------------|----------|----------|----------|----------|----------|----------|------|
| Peak Repetitive Reverse Voltage                                                                                       | V <sub>RRM</sub>                  | 50          | 100      | 200      | 400      | 600      | 800      | 1000     | V    |
| Working Peak Reverse Voltage                                                                                          | V <sub>RWM</sub>                  |             |          |          |          |          |          |          |      |
| DC Blocking Voltage                                                                                                   | V <sub>R</sub>                    |             |          |          |          |          |          |          |      |
| RMS Reverse Voltage                                                                                                   | V <sub>R(RMS)</sub>               | 35          | 70       | 140      | 280      | 420      | 560      | 700      | V    |
| Average Rectified Output Current @ T <sub>T</sub> = 75°C                                                              | I <sub>O</sub>                    | 3.0         |          |          |          |          |          |          | A    |
| Non-Repetitive Peak Forward Surge Current<br>8.3ms Single half sine-wave Superimposed on Rated Load<br>(JEDEC Method) | I <sub>FSM</sub>                  | 100         |          |          |          |          |          |          | A    |
| Forward Voltage @ I <sub>F</sub> = 3.0A                                                                               | V <sub>FM</sub>                   | 1.3         |          |          |          |          |          |          | V    |
| Peak Reverse Current @ T <sub>A</sub> = 25°C<br>at Rated DC Blocking Voltage @ T <sub>A</sub> = 125°C                 | I <sub>RM</sub>                   | 5.0<br>250  |          |          |          |          |          |          | μA   |
| Maximum Recovery Time (Note 3)                                                                                        | t <sub>rr</sub>                   | 150         |          |          |          | 250      | 500      |          | ns   |
| Typical Junction Capacitance (Note 2)                                                                                 | C <sub>j</sub>                    | 50          |          |          |          |          |          |          | pF   |
| Typical Thermal Resistance Junction to Terminal (Note 1)                                                              | R <sub>θJT</sub>                  | 25          |          |          |          |          |          |          | K/W  |
| Operating and Storage Temperature Range                                                                               | T <sub>j</sub> , T <sub>STG</sub> | -65 to +150 |          |          |          |          |          |          | °C   |

- Notes:
1. Thermal resistance: junction to terminal, unit mounted on PC board with 5.0 mm<sup>2</sup> (0.013 mm thick) copper pad as heat sink.
  2. Measured at 1.0MHz and applied reverse voltage of 4.0V DC.
  3. Reverse recovery test conditions: I<sub>F</sub> = 0.5A, I<sub>R</sub> = 1.0A, I<sub>rr</sub> = 0.25A. See figure 5.

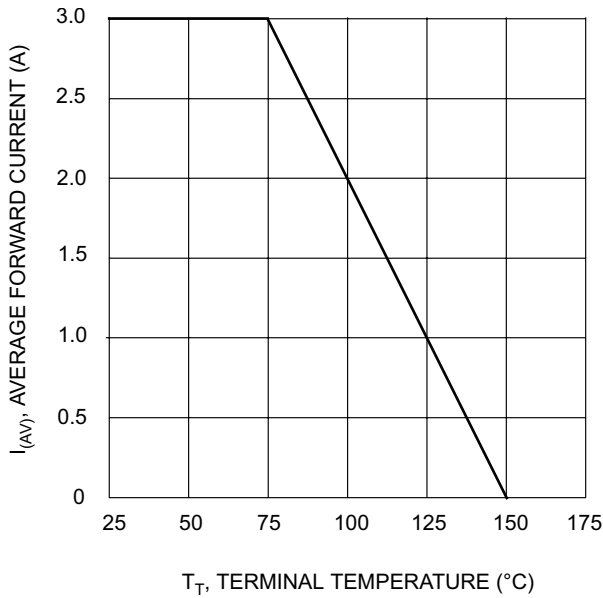

Fig. 1 Forward Current Derating Curve

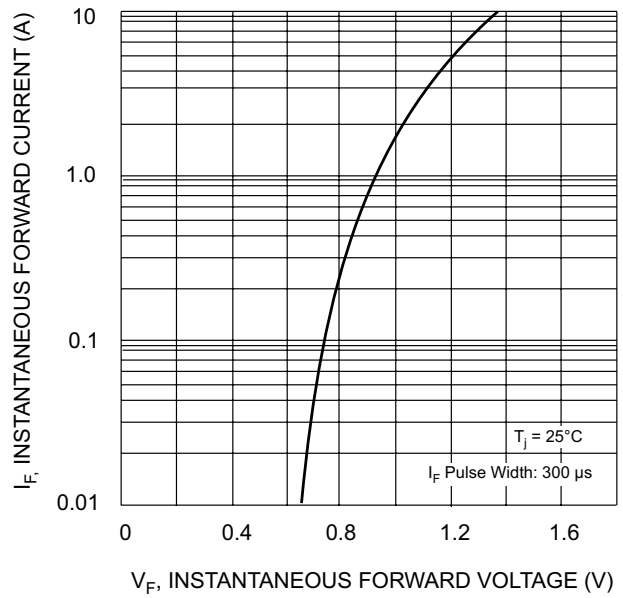

Fig. 2 Typical Forward Characteristics

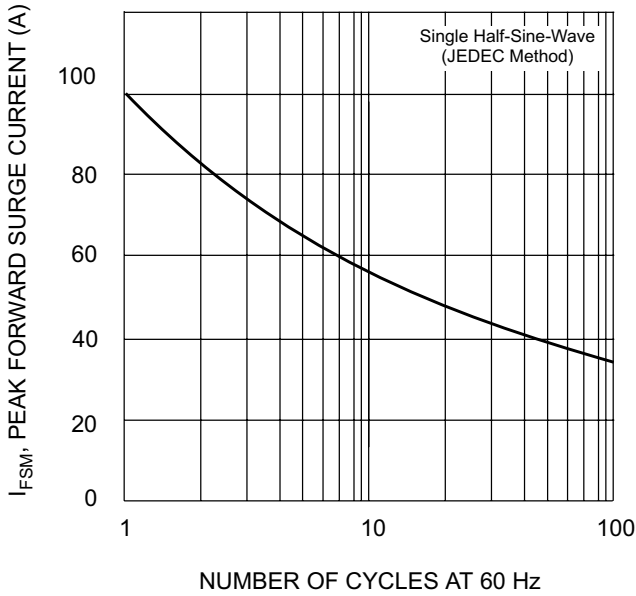

Fig. 3 Forward Surge Current Derating Curve

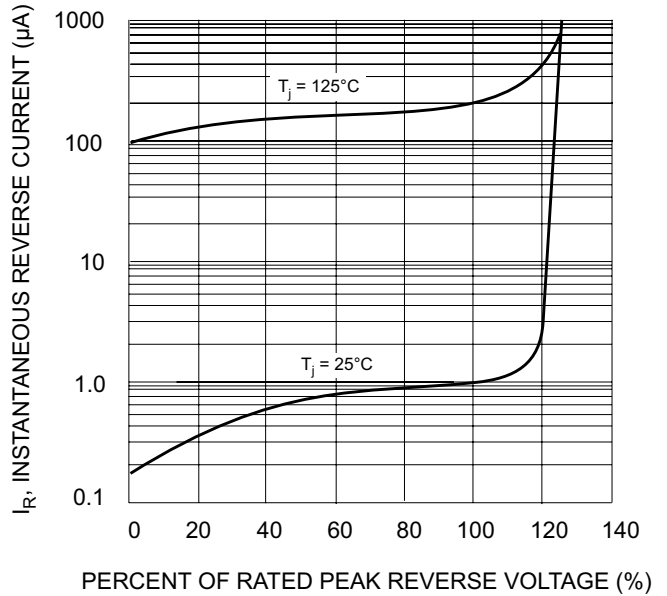
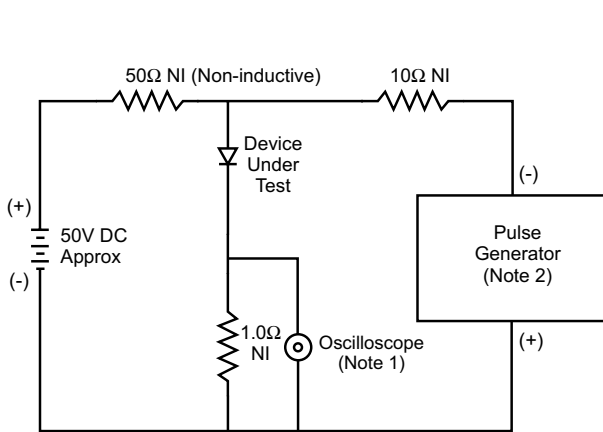
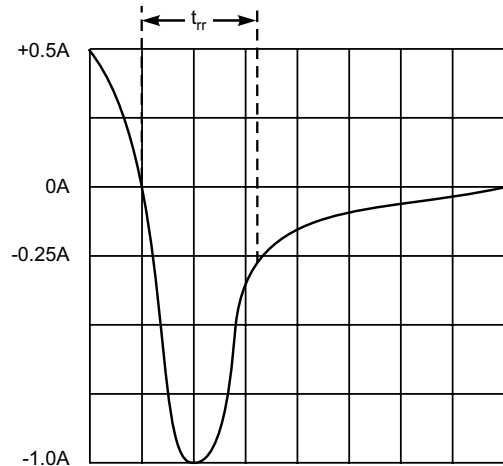

Fig. 4 Typical Reverse Characteristics



- Notes:
1. Rise Time = 7.0ns max. Input Impedance = 1.0M $\Omega$ , 22pF.
  2. Rise Time = 10ns max. Input Impedance = 50 $\Omega$ .



Set time base for 50/100 ns/cm

Fig. 5 Reverse Recovery Time Characteristic and Test Circuit

单击下面可查看定价，库存，交付和生命周期等信息

[>>Diodes Incorporated\(达达科技\(美台\)\)](#)