

## Description

The AH3767Q is an AEC-Q100 qualified high-voltage, low-sensitivity Hall-Effect latch IC designed for brushless DC-motor commutation, speed measurement, angular or linear encoders and position sensors in automotive applications. To support a wide range of demanding applications, the design is optimized to operate over the supply range of 3.0V to 28V. With chopper stabilized architecture and an internal bandgap regulator to provide temperature compensated supply for internal circuits, the AH3767Q provides a reliable solution over the whole operating range. For robustness and protection, the device has a reverse blocking diode with a Zener clamp on the supply. The output has an over current limit and a Zener clamp.

The single, open-drain output can be switched on with South pole of sufficient strength and switched off with North pole of sufficient strength. When the magnetic flux density (B) perpendicular to the package is larger than the operate point ( $B_{op}$ ) the output is switched on (pulled low). The output is held latched until magnetic flux density reverses and becomes lower than the release point ( $B_{rp}$ ).

## Features

- Bipolar Latch Operation (South Pole: On, North Pole: off)
- High Sensitivity:  $B_{op}$  and  $B_{rp}$  of +140G and -140G Typical
- Single Open-Drain Output with Overcurrent Limit
- 3.0V to 28V Operating Voltage Range
- Chopper Stabilized Design Provides
  - Superior Temperature Stability
  - Minimal Switch Point Drift
  - Enhanced Immunity to Stress
- Good RF Noise Immunity
- Reverse Blocking Diode
- Zener Clamp on Supply and Output Pins
- -40°C to +150°C Operating Temperature
- ESD: HBM >8kV, CDM: >2kV
- AEC-Q100 Grade 0 Qualified
- Industry Standard SOT23 and SIP-3 Packages
- **Totally Lead-Free & Fully RoHS Compliant (Notes 1 & 2)**
- **Halogen and Antimony Free. "Green" Device (Note 3)**

Notes:

1. No purposely added lead. Fully EU Directive 2002/95/EC (RoHS) & 2011/65/EU (RoHS 2) compliant.
2. See [http://www.diodes.com/quality/lead\\_free.html](http://www.diodes.com/quality/lead_free.html) for more information about Diodes Incorporated's definitions of Halogen- and Antimony-free, "Green" and Lead-free.
3. Halogen- and Antimony-free "Green" products are defined as those which contain <900ppm bromine, <900ppm chlorine (<1500ppm total Br + Cl) and <1000ppm antimony compounds.

## Pin Assignments

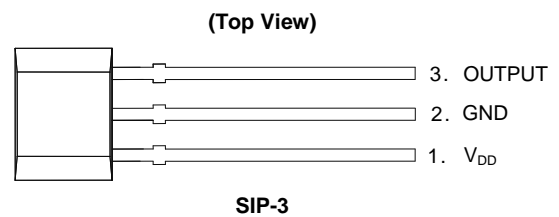
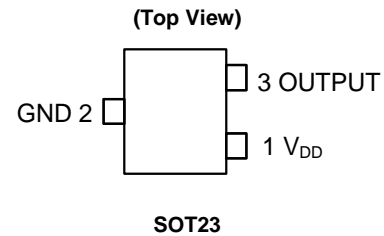

## Applications

- Brushless DC-Motor Commutation
- Revolution Per Minute (RPM) Measurement
- Angular and Linear Encoder and Position Sensing and Indexing
- Flow Meters
- Contactless Commutation, Speed Measurement and Angular Position Sensing/Indexing in Automotive Applications

**Typical Applications Circuit**

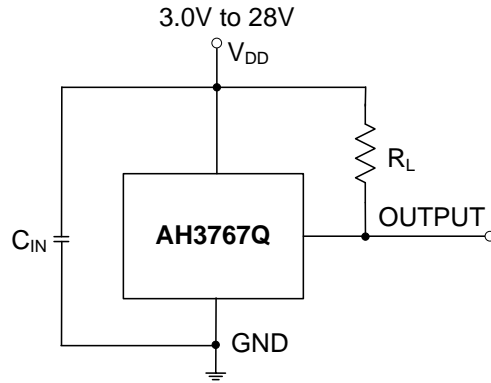

Note: 4.  $C_{IN}$  is for power stabilization and to strengthen the noise immunity, the recommended capacitance is 10nF ~ 100nF.  $R_L$  is the pull-up resistor.

**Pin Descriptions**

Package: SOT23 and SIP-3

Pin Number	Pin Name	Function
1	V <sub>DD</sub>	Power Supply Input
2	GND	Ground
3	OUTPUT	Output Pin

**Functional Block Diagram**

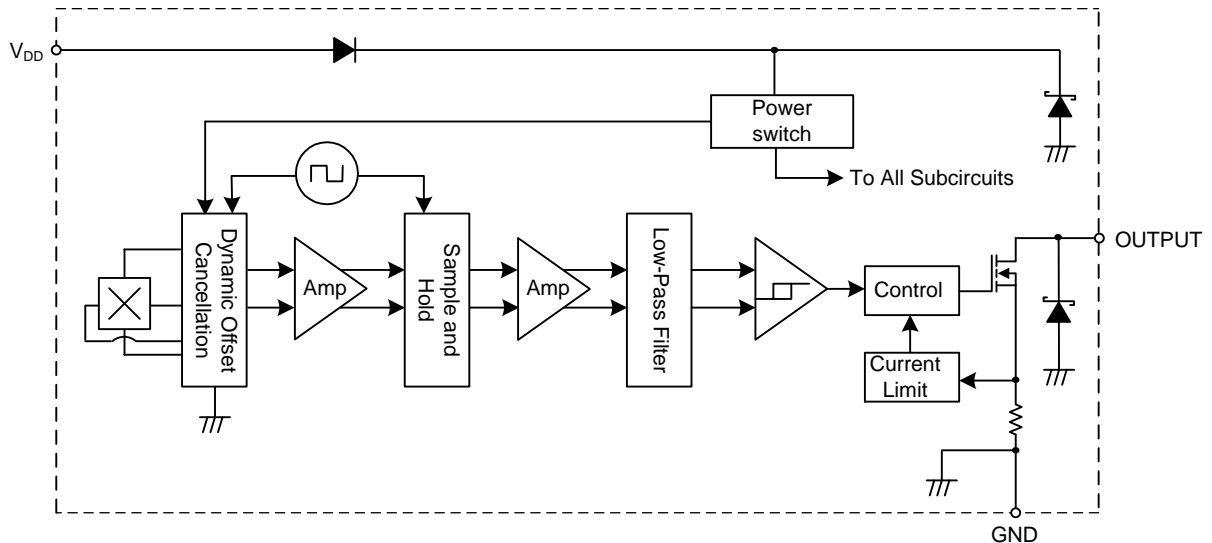

**Absolute Maximum Ratings** (Notes 5 & 6) (@T<sub>A</sub> = +25°C, unless otherwise specified.)

Symbol	Characteristic	Value	Unit	
V <sub>DD</sub>	Supply Voltage (Note 6)	32	V	
V <sub>DDR</sub>	Reverse Supply Voltage (Note 6)	-32	V	
V <sub>OUT_MAX</sub>	Output Off Voltage (Note 6)	32	V	
I <sub>OUT</sub>	Continuous Output Current	60	mA	
I <sub>OUT_R</sub>	Reverse Output Current	-50	mA	
B	Magnetic Flux Density	Unlimited		
P <sub>D</sub>	Package Power Dissipation	SIP-3	550	mW
		SOT23	230	
T <sub>s</sub>	Storage Temperature Range	-65 to +165	°C	
T <sub>J</sub>	Maximum Junction Temperature	+150	°C	
ESD HBM	Electros Static Discharge Withstand - Human Body Model (HMB)	8	kV	
ESD MM	Electros Static Discharge Withstand - Machine Model (MM)	800	V	
ESD CDM	Electros Static Discharge Withstand - Charged Device Model (CDM)	2	kV	

- Notes:
- Stresses greater than the 'Absolute Maximum Ratings' specified above may cause permanent damage to the device. These are stress ratings only; functional operation of the device at these or any other conditions exceeding those indicated in this specification is not implied. Device reliability may be affected by exposure to absolute maximum rating conditions for extended periods of time.
  - The absolute maximum V<sub>DD</sub> of 32V is a transient stress rating and is not meant as a functional operating condition. It is not recommended to operate the device at the absolute maximum rated conditions for any period of time.

**Recommended Operating Conditions** (@T<sub>A</sub> = -40°C to +150°C, unless otherwise specified.)

Symbol	Parameter	Conditions	Rating	Unit
V <sub>DD</sub>	Supply Voltage	Operating	3.0 to 28	V
T <sub>A</sub>	Operating Temperature Range	Operating	-40 to +150	°C

**Electrical Characteristics** (Notes 7 & 8) (@T<sub>A</sub> = -40°C to +150°C, V<sub>DD</sub> = 3V to 28V, unless otherwise specified.)

Symbol	Parameter	Conditions	Min	Typ	Max	Unit
V <sub>OUT_ON</sub>	Output On Voltage	I <sub>OUT</sub> = 20mA, B > B <sub>op</sub>	-	0.2	0.4	V
I <sub>LKG</sub>	Output Leakage Current (when output is off)	V <sub>OUT</sub> = 28V, B < B <sub>rp</sub> , Output off	-	<0.1	10	µA
I <sub>DD</sub>	Supply Current	Output open, T <sub>A</sub> = +25°C	-	3	3.5	mA
		Output open, T <sub>A</sub> = -40°C to +150°C	-	-	4	mA
I <sub>DD_R</sub>	Reverse Supply Current	V <sub>DD</sub> = -18V, T <sub>A</sub> = +25°C	-	0.6	-	µA
		V <sub>DD</sub> = -18V, T <sub>A</sub> = -40°C to +150°C	-	0.6	1,500	µA
		V <sub>DD</sub> = -28V, T <sub>A</sub> = +25°C	-	1.6	-	µA
		V <sub>DD</sub> = -28V, T <sub>A</sub> = -40°C to +150°C	-	1.6	2,500	µA
t <sub>P_ON</sub>	Device Power-On Time (start-up time)	V <sub>DD</sub> ≥ 3V, B > B <sub>op</sub> (Note 7)	-	10	-	µs
f <sub>c</sub>	Chopping Frequency	V <sub>DD</sub> ≥ 3V	-	800	-	kHz
t <sub>d</sub>	Response Time Delay (time from magnetic threshold reached to the start of the output rise or fall)	(Note 9)	-	3.75	-	µs
t <sub>r</sub>	Output Rising Time (external pull-up resistor R <sub>L</sub> and load capacitance dependent)	R <sub>L</sub> = 1kΩ, C <sub>L</sub> = 20pF	-	0.2	1	µs
t <sub>f</sub>	Output Falling Time (Internal switch resistance and load capacitance dependent)	R <sub>L</sub> = 1kΩ, C <sub>L</sub> = 20pF	-	0.1	1	µs
I <sub>OCL</sub>	Output Current Limit	B > B <sub>op</sub> , (Note 10)	30	-	55	mA
V <sub>Z</sub>	Zener Clamp Voltage	I <sub>DD</sub> = 5mA	28	-	-	V

- Notes:
- When power is initially turned on, V<sub>DD</sub> must be within its correct operating range (3.0V to 28V) to guarantee the output sampling. The output state is valid after the start-up time of 10µs typical from the operating voltage reaching 3V.
  - Typical values are defined at T<sub>A</sub> = +25°C, V<sub>DD</sub> = 12V. Maximum and minimum values over the operating temperature range is not tested in production but guaranteed by design, process control and characterization.
  - Guaranteed by design, process control and characterization. Not tested in production.
  - The device will limit the output current I<sub>OUT</sub> to current limit of I<sub>OCL</sub>.

**Magnetic Characteristics** (Notes 11 & 12) ( $T_A = -40^{\circ}\text{C}$  to  $+150^{\circ}\text{C}$ ,  $V_{DD} = 3.0\text{V}$  to  $28\text{V}$ , unless otherwise specified)

(1mT=10 Gauss)

Symbol	Parameter	Conditions	Min	Typ	Max	Unit
$B_{ops}$ (South pole to part marking side for SOT23 and SIP-3 packages)	Operation Point	$V_{DD} = 12\text{V}$ , $T_A = +25^{\circ}\text{C}$	-	140	-	Gauss
		$T_A = -40^{\circ}\text{C}$ to $+150^{\circ}\text{C}$	110	140	170	
$B_{rps}$ (North pole to part marking side for SOT23 and SIP-3 packages)	Release Point	$V_{DD} = 12\text{V}$ , $T_A = +25^{\circ}\text{C}$	-	-140	-	
		$T_A = -40^{\circ}\text{C}$ to $+150^{\circ}\text{C}$	-170	-140	-110	
$B_{hy}$ ( $ B_{opx}  -  B_{rpx} $ )	Hysteresis (Note 13)	$V_{DD} = 12\text{V}$ , $T_A = +25^{\circ}\text{C}$	-	280	-	
		$T_A = -40^{\circ}\text{C}$ to $+150^{\circ}\text{C}$	220	280	340	

- Notes:
- When power is initially turned on,  $V_{DD}$  must be within its correct operating range (3.0V to 28V) to guarantee the output sampling. The output state is valid after the start-up time of 10 $\mu\text{s}$  typical from the operating voltage reaching 3V.
  - Typical values are defined at  $T_A = +25^{\circ}\text{C}$ ,  $V_{DD} = 12\text{V}$ . Maximum and minimum values over the operating temperature range is not tested in production but guaranteed by design, process control and characterization.
  - Maximum and minimum hysteresis is guaranteed by design, process control and characterization.

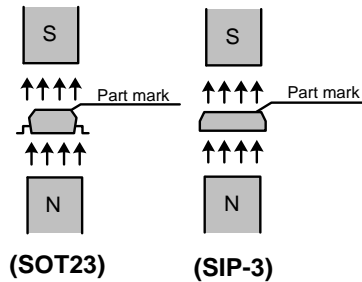
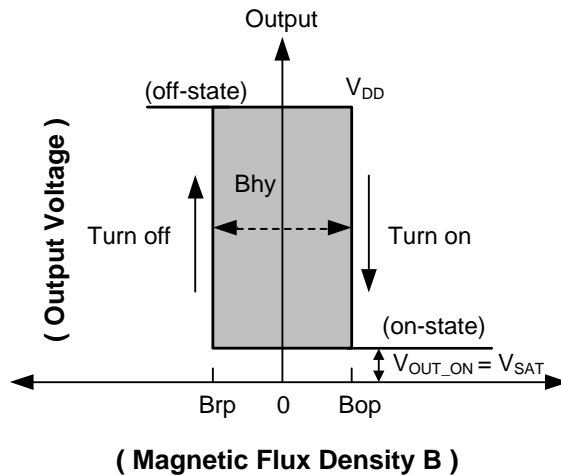

**Typical Operating Characteristics**

**Output Switch Operate and Release Points (Magnetic Thresholds) – B<sub>op</sub> and B<sub>rp</sub>**

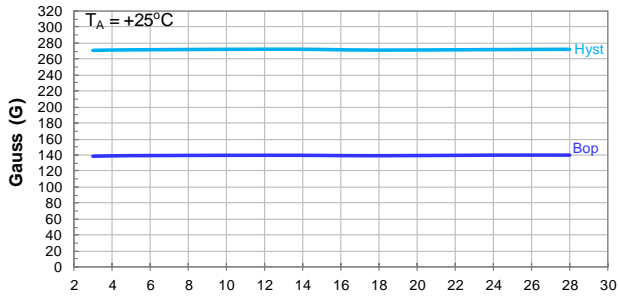

Supply Voltage (V)  
Switch Operate Point Bop vs Supply Voltage

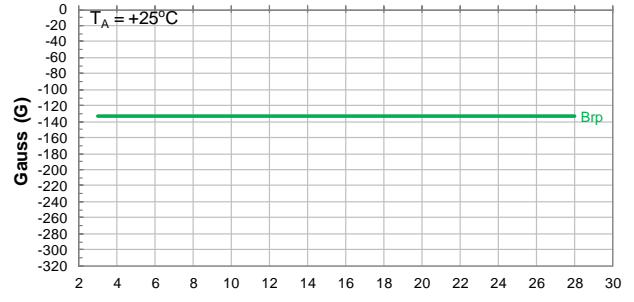

Supply Voltage (V)  
Switch Release Point Brp vs Supply Voltage

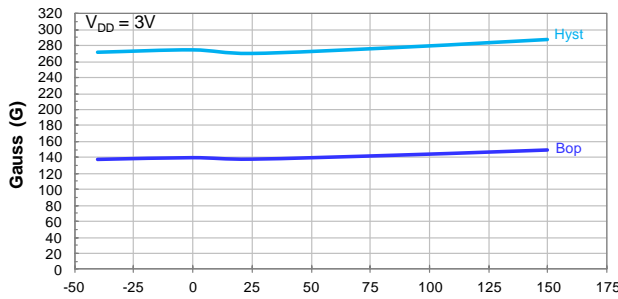

Temperature (°C)  
Switch Operate Point Bop vs Temperature

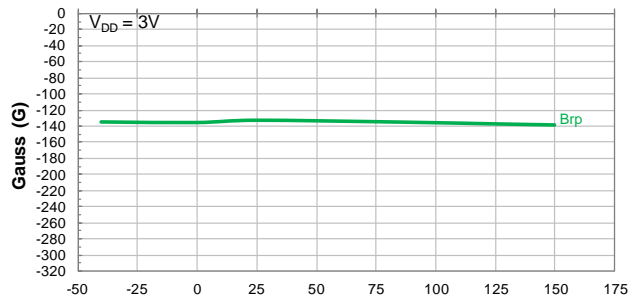

Temperature (°C)  
Switch Release Point Brp vs Temperature

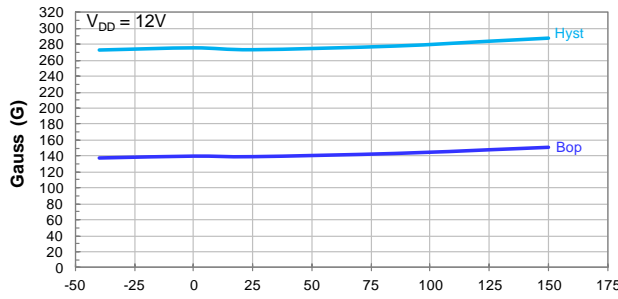

Temperature (°C)  
Switch Operate Point Bop vs Temperature

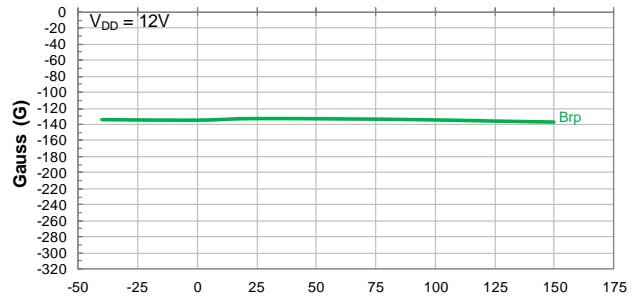

Temperature (°C)  
Switch Release Point Brp vs Temperature

**Typical Operating Characteristics**

**Output Switch Operate and Release Points (Magnetic Thresholds) – B<sub>op</sub> and B<sub>rp</sub> (cont.)**

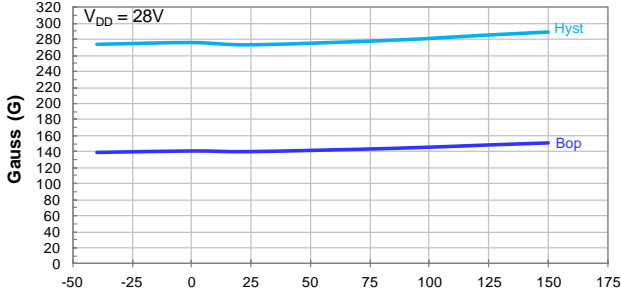

Temperature (°C)  
Switch Operate Point Bop vs Temperature

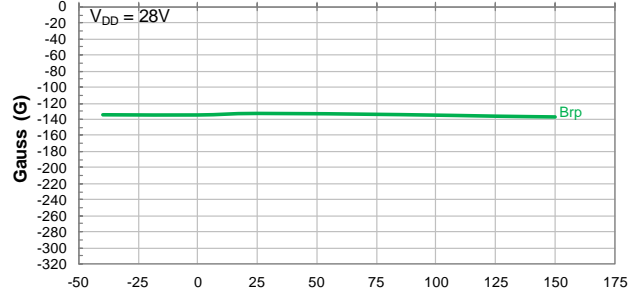

Temperature (°C)  
Switch Release Point Brp vs Temperature

**Supply Current**

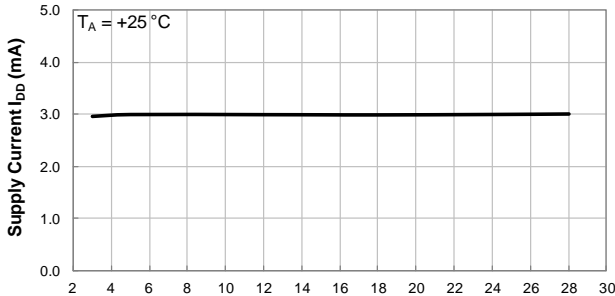

Supply Voltage (V)  
Supply Current vs Supply Voltage

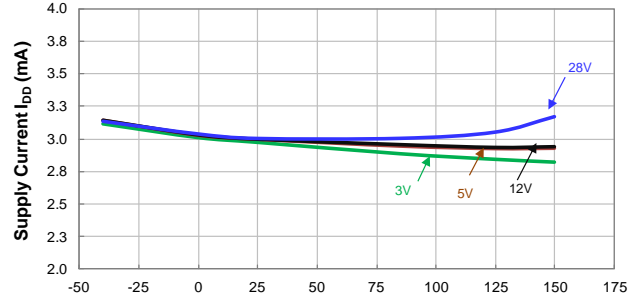

Temperature (°C)  
Supply Current vs Temperature

**Reverse Supply Current**

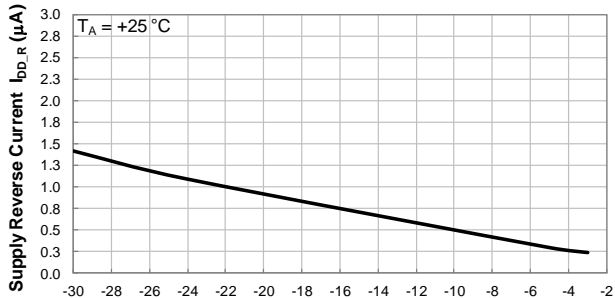

Supply Voltage (V)  
Reverse Supply Current vs Supply Voltage

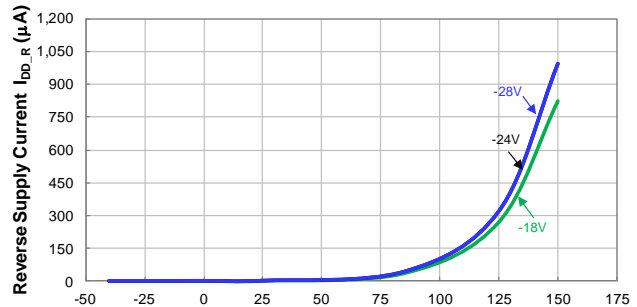

Temperature (°C)  
Reverse Supply Current vs Temperature

**Typical Operating Characteristics (cont.)**

**Output Switch On Voltage**

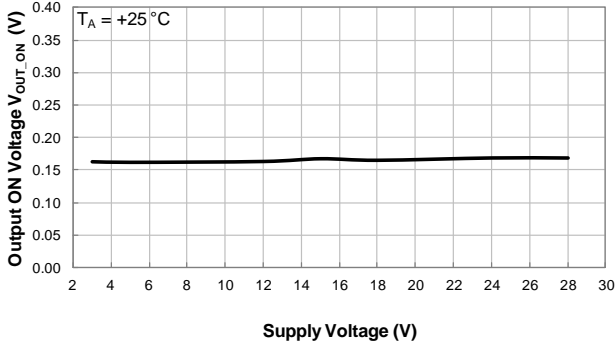

Output ON Voltage vs Supply Voltage

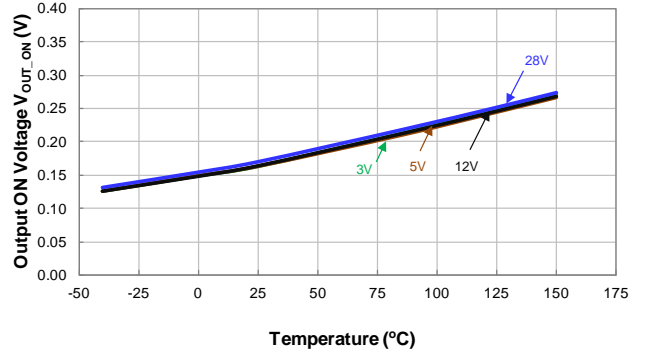

Output ON Voltage vs Temperature

**Output Switch Leakage Current**

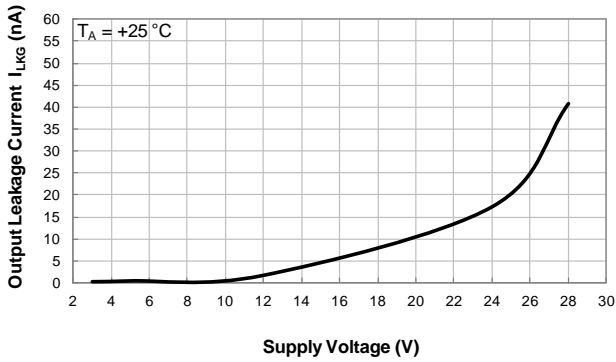

Output Leakage Current vs Supply Voltage

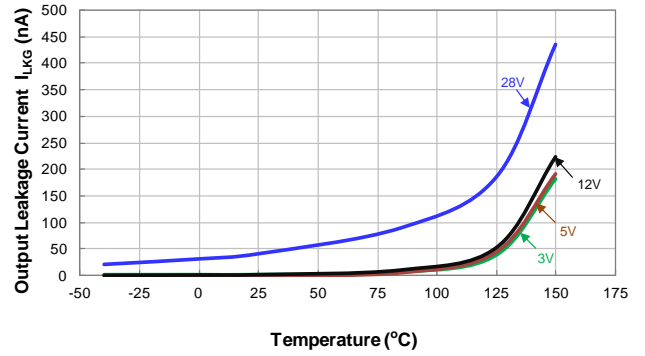

Output Leakage Current vs Temperature

**Output Current Limit**

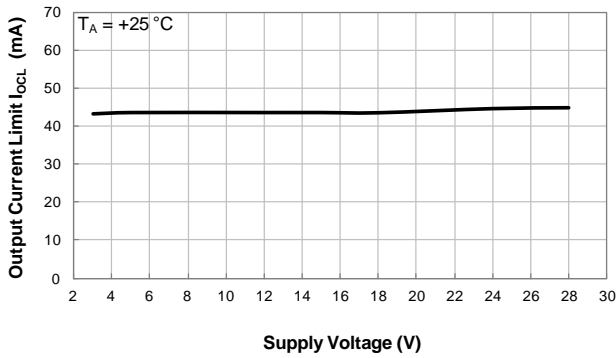

Output Current Limit vs Supply Voltage

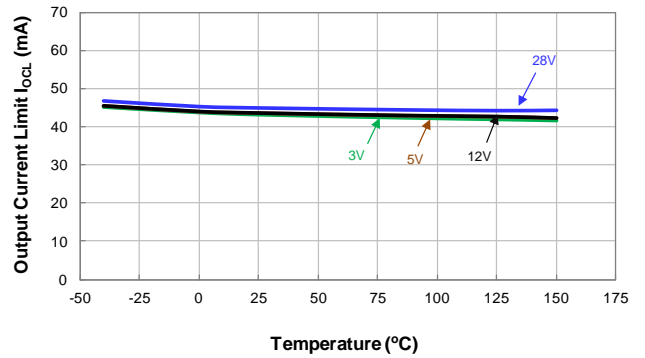

Output Current Limit vs Temperature

**Thermal Performance Characteristics**

(1) Package type: SOT23

T <sub>A</sub> (°C)	25	50	60	70	80	85	90	100	105	110	120	125	130	140	150
P <sub>D</sub> (mW)	230	184	166	147	129	120	110	92	83	74	55	46	37	18	0

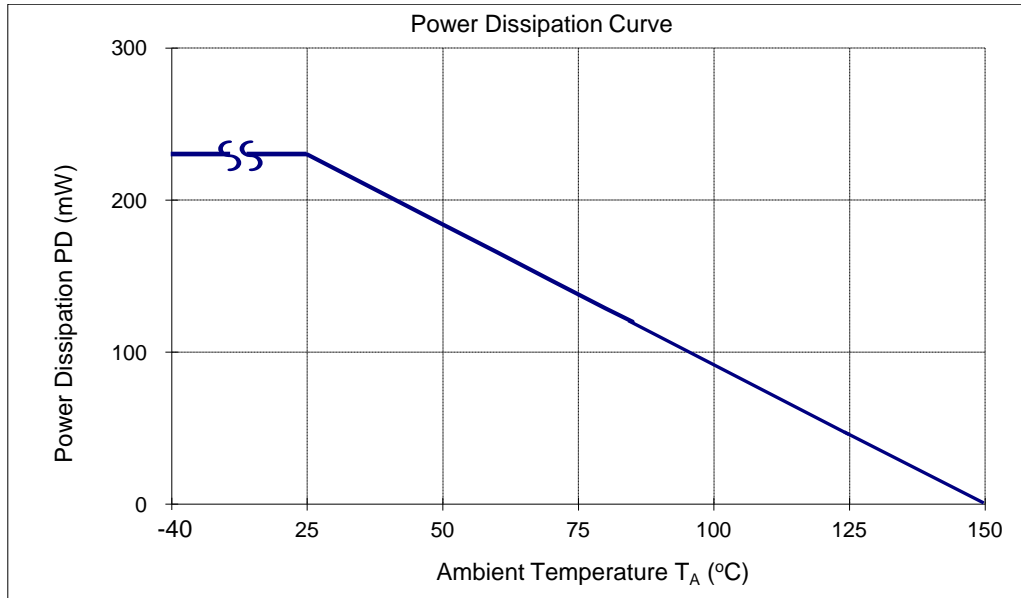

(2) Package type: SIP-3

T <sub>A</sub> (°C)	25	50	60	70	80	85	90	100	105	110	120	125	130	140	150
P <sub>D</sub> (mW)	550	440	396	362	308	286	264	220	198	176	132	110	88	44	0

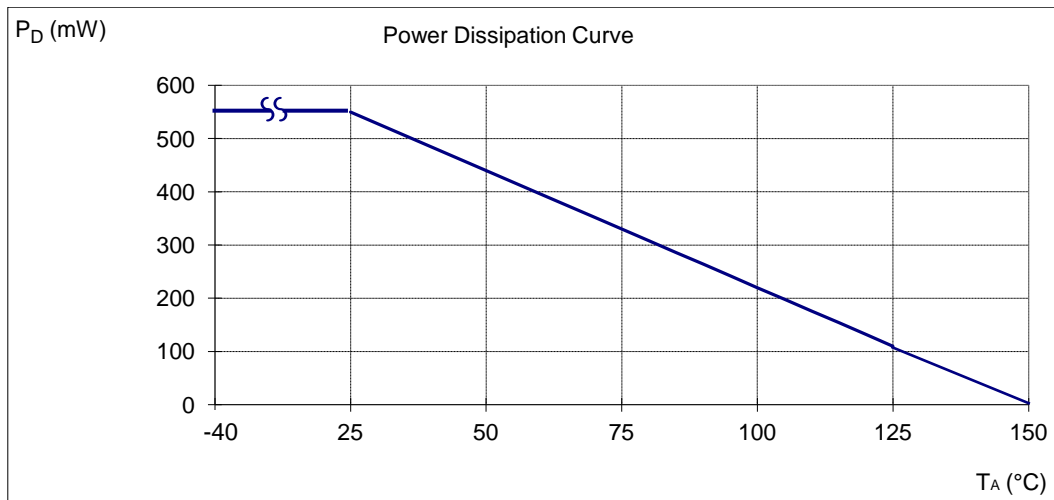



**Ordering Information**

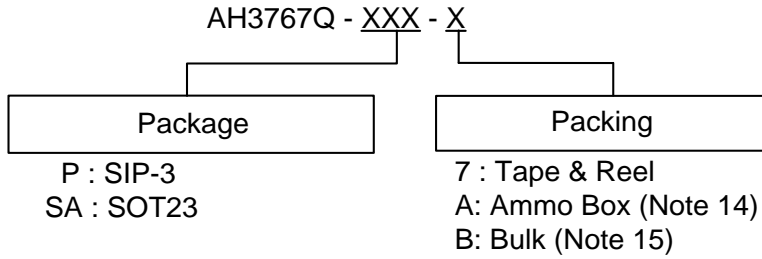

Part Number	Package Code	Packaging	Bulk		7" Tape and Reel		Ammo Box	
			Quantity	Part Number Suffix	Quantity	Part Number Suffix	Quantity	Part Number Suffix
AH3767Q-P-A	P	SIP-3	NA	NA	NA	NA	4,000/Box	-A
AH3767Q-P-B	P	SIP-3	1,000	-B	NA	NA	NA	NA
AH3767Q-SA-7	SA	SOT23	NA	NA	3,000/Tape & Reel	-7	NA	NA

Notes: 14. Ammo Box is for SIP-3 Spread Lead.  
15. Bulk is for SIP-3 Straight Lead.

**Marking Information**

(1) Package Type: SOT23

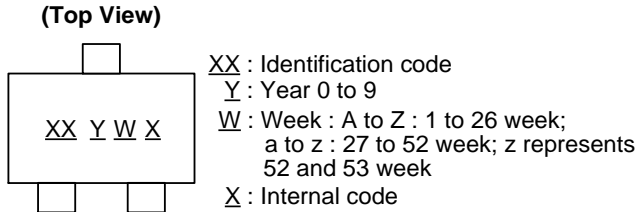

Part Number	Package	Identification Code
AH3767Q	SOT23	WS

(2) Package Type: SIP-3

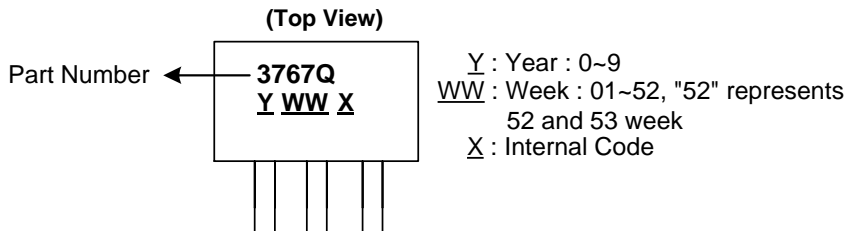

Part Number	Package	Identification Code
AH3767Q	SIP-3	3767Q

**Package Outline Dimensions** (All dimensions in mm.)

Please see AP02002 at <http://www.diodes.com/datasheets/ap02002.pdf> for the latest version.

(1) Package Type: SOT23

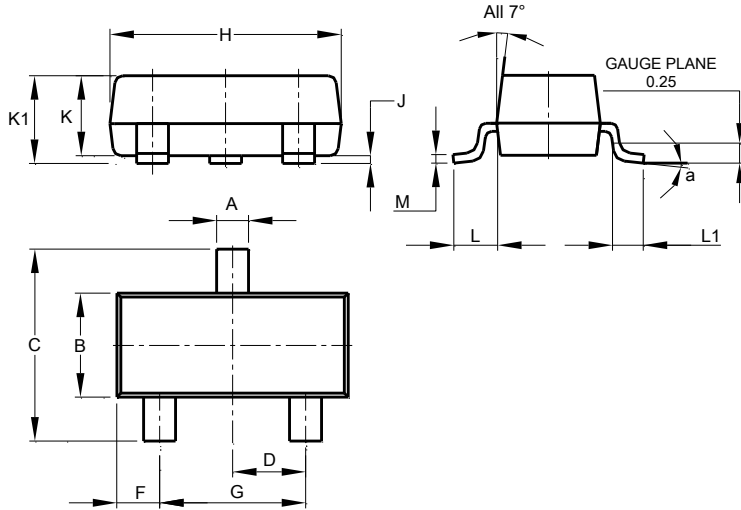

SOT23			
Dim	Min	Max	Typ
A	0.37	0.51	0.40
B	1.20	1.40	1.30
C	2.30	2.50	2.40
D	0.89	1.03	0.915
F	0.45	0.60	0.535
G	1.78	2.05	1.83
H	2.80	3.00	2.90
J	0.013	0.10	0.05
K	0.890	1.00	0.975
K1	0.903	1.10	1.025
L	0.45	0.61	0.55
L1	0.25	0.55	0.40
M	0.085	0.150	0.110
a	8°		
All Dimensions in mm			

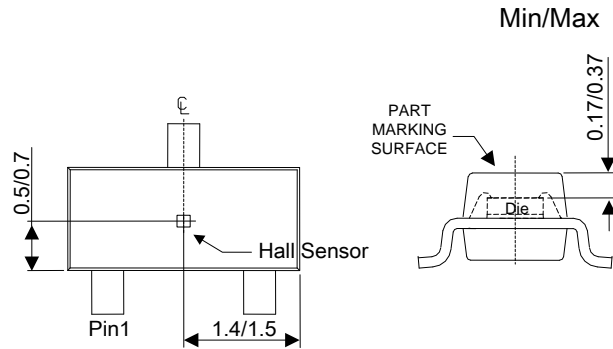

Sensor Location – To be updated

**Package Outline Dimensions** (cont.) (All dimensions in mm.)

Please see AP02002 at <http://www.diodes.com/datasheets/ap02002.pdf> for the latest version.

(2) Package Type: SIP-3 Bulk

Sensor location to be added

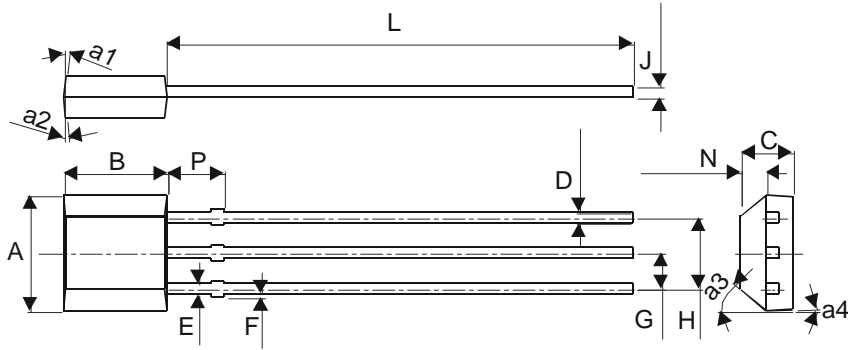

SIP-3 (Bulk)		
Dim	Min	Max
A	3.9	4.3
a1	5° Typ	
a2	5° Typ	
a3	45° Typ	
a4	3° Typ	
B	2.8	3.2
C	1.40	1.60
D	0.33	0.432
E	0.40	0.508
F	0	0.2
G	1.24	1.30
H	2.51	2.57
J	0.35	0.43
L	14.0	15.0
N	0.63	0.84
P	1.55	-
<b>All Dimensions in mm</b>		

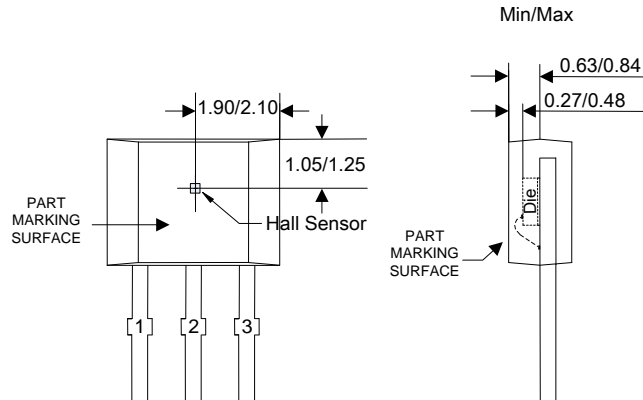

Sensor Location – To be updated

**Package Outline Dimensions** (cont.) (All dimensions in mm.)

Please see AP02002 at <http://www.diodes.com/datasheets/ap02002.pdf> for the latest version.

(3) Package Type: SIP-3 Ammo Pack

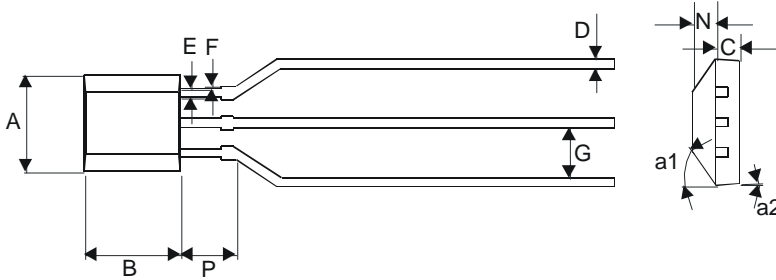

SIP-3 (Ammo Pack)		
Dim	Min	Max
A	3.9	4.3
a1	45° Typ	
a2	3° Typ	
B	2.8	3.2
C	1.40	1.60
D	0.35	0.41
E	0.43	0.48
F	0	0.2
G	2.4	2.9
N	0.63	0.84
P	1.55	-
All Dimensions in mm		

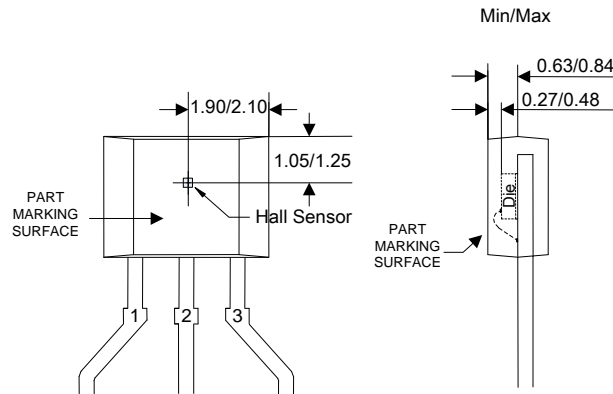

Sensor Location – To be updated

**Suggested Pad Layout**

Please see AP02001 at <http://www.diodes.com/datasheets/ap02001.pdf> for the latest version.

(1) Package Type: SOT23

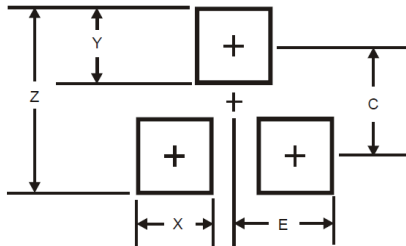

Dimensions	Value (in mm)
Z	2.9
X	0.8
Y	0.9
C	2.0
E	1.35

**IMPORTANT NOTICE**

DIODES INCORPORATED MAKES NO WARRANTY OF ANY KIND, EXPRESS OR IMPLIED, WITH REGARDS TO THIS DOCUMENT, INCLUDING, BUT NOT LIMITED TO, THE IMPLIED WARRANTIES OF MERCHANTABILITY AND FITNESS FOR A PARTICULAR PURPOSE (AND THEIR EQUIVALENTS UNDER THE LAWS OF ANY JURISDICTION).

Diodes Incorporated and its subsidiaries reserve the right to make modifications, enhancements, improvements, corrections or other changes without further notice to this document and any product described herein. Diodes Incorporated does not assume any liability arising out of the application or use of this document or any product described herein; neither does Diodes Incorporated convey any license under its patent or trademark rights, nor the rights of others. Any Customer or user of this document or products described herein in such applications shall assume all risks of such use and will agree to hold Diodes Incorporated and all the companies whose products are represented on Diodes Incorporated website, harmless against all damages.

Diodes Incorporated does not warrant or accept any liability whatsoever in respect of any products purchased through unauthorized sales channel. Should Customers purchase or use Diodes Incorporated products for any unintended or unauthorized application, Customers shall indemnify and hold Diodes Incorporated and its representatives harmless against all claims, damages, expenses, and attorney fees arising out of, directly or indirectly, any claim of personal injury or death associated with such unintended or unauthorized application.

Products described herein may be covered by one or more United States, international or foreign patents pending. Product names and markings noted herein may also be covered by one or more United States, international or foreign trademarks.

This document is written in English but may be translated into multiple languages for reference. Only the English version of this document is the final and determinative format released by Diodes Incorporated.

**LIFE SUPPORT**

Diodes Incorporated products are specifically not authorized for use as critical components in life support devices or systems without the express written approval of the Chief Executive Officer of Diodes Incorporated. As used herein:

A. Life support devices or systems are devices or systems which:

1. are intended to implant into the body, or
2. support or sustain life and whose failure to perform when properly used in accordance with instructions for use provided in the labeling can be reasonably expected to result in significant injury to the user.

B. A critical component is any component in a life support device or system whose failure to perform can be reasonably expected to cause the failure of the life support device or to affect its safety or effectiveness.

Customers represent that they have all necessary expertise in the safety and regulatory ramifications of their life support devices or systems, and acknowledge and agree that they are solely responsible for all legal, regulatory and safety-related requirements concerning their products and any use of Diodes Incorporated products in such safety-critical, life support devices or systems, notwithstanding any devices- or systems-related information or support that may be provided by Diodes Incorporated. Further, Customers must fully indemnify Diodes Incorporated and its representatives against any damages arising out of the use of Diodes Incorporated products in such safety-critical, life support devices or systems.

Copyright © 2015, Diodes Incorporated

[www.diodes.com](http://www.diodes.com)

单击下面可查看定价，库存，交付和生命周期等信息

[>>Diodes Incorporated\(达达科技\(美台\)\)](#)