

**Product Summary** (@ $T_A = +25^\circ\text{C}$ )

$V_{RRM}$ (V)	$I_O$ (mA)	$V_F$ MAX (V)	$I_R$ MAX ( $\mu\text{A}$ )
40	250	0.725	2.0

**Description**

The BAT64T5Q 250mA surface mount Schottky Barrier Diode in SOD523 package offers low turn-on voltage and fast switching capability, designed with PN Junction Guard Ring for Transient Protection.

**Features**

- Low Forward Voltage Drop
- Fast Switching
- Ultra-Small Surface Mount Package
- PN Junction Guard Ring for Transient Protection
- **Totally Lead-Free & Fully RoHS Compliant (Notes 1 & 2)**
- **Halogen and Antimony Free. "Green" Device (Note 3)**
- **The BAT64T5Q is suitable for automotive applications requiring specific change control and is AEC-Q101 qualified, is PPAP capable, and is manufactured in IATF16949:2016 certified facilities.**

**Mechanical Data**

- Case: SOD523
- Case Material: Molded Plastic, "Green" Molding Compound. UL Flammability Classification Rating 94V-0
- Moisture Sensitivity: Level 1 per J-STD-020
- Terminal Connections: Cathode Band
- Terminals: Matte Tin Finish Annealed over Alloy 42 Leadframe (Lead Free Plating). Solderable per MIL-STD-202, Method 208<sup>(3)</sup>
- Polarity: See Diagrams Below
- Weight: 0.006 grams (Approximate)

SOD523



Top View

**Ordering Information** (Note 4)

Part Number	Compliance	Case	Packaging
BAT64T5Q-7-F	Automotive	SOD523 (Note 5)	3,000/Tape & Reel
BAT64T5Q-13-F	Automotive	SOD523 (Note 5)	10,000/Tape & Reel

- Notes:
1. No purposely added lead. Fully EU Directive 2002/95/EC (RoHS), 2011/65/EU (RoHS 2) & 2015/863/EU (RoHS 3) compliant.
  2. See <https://www.diodes.com/quality/lead-free/> for more information about Diodes Incorporated's definitions of Halogen- and Antimony-free, "Green" and Lead-free.
  3. Halogen- and Antimony-free "Green" products are defined as those which contain <900ppm bromine, <900ppm chlorine (<1500ppm total Br + Cl) and <1000ppm antimony compounds.
  4. For packaging details, go to our website at <https://www.diodes.com/design/support/packaging/diodes-packaging/>.
  5. Dispensed in every other cavity of the tape.

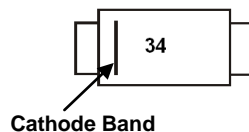
**Marking Information**

34 = Product Type Marking Code

**Maximum Ratings** (@T<sub>A</sub> = +25°C, unless otherwise specified.)

Characteristic	Symbol	Value	Unit
Peak Repetitive Reverse Voltage Working Peak Reverse Voltage DC Blocking Voltage	V <sub>RRM</sub> V <sub>RWM</sub> V <sub>R</sub>	40	V
Forward Continuous Current (Note 6)	I <sub>F</sub>	250	mA
Repetitive Peak Forward Current (Note 6)	I <sub>FRM</sub>	300	mA
Non-Repetitive Peak Forward Surge Current 8.3ms Single Half Sine-Wave Superimposed on Rated Load (Note 6)	I <sub>FSM</sub>	1,200	mA

**Thermal Characteristics**

Characteristic	Symbol	Value	Unit
Power Dissipation (Note 6)	P <sub>D</sub>	250	mW
Thermal Resistance Junction to Ambient Air (Note 6)	R <sub>θJA</sub>	500	°C/W
Junction and Storage Temperature Range	T <sub>J</sub> , T <sub>STG</sub>	-65 to +150	°C

**Electrical Characteristics** (@T<sub>A</sub> = +25°C, unless otherwise specified.)

Characteristic	Symbol	Min	Typ	Max	Unit	Test Condition
Reverse Breakdown Voltage (Note 7)	V <sub>(BR)R</sub>	40	—	—	V	I <sub>R</sub> = 100μA
Forward Voltage	V <sub>F</sub>	—	270 350 430 610	310 390 480 725	mV	I <sub>F</sub> = 1mA I <sub>F</sub> = 10mA I <sub>F</sub> = 30mA I <sub>F</sub> = 100mA
Reverse Leakage Current (Note 7)	I <sub>R</sub>	—	0.2	2.0	μA	V <sub>R</sub> = 40V
Total Capacitance	C <sub>T</sub>	—	—	6	pF	V <sub>R</sub> = 5V, f = 1.0MHz
Reverse Recovery Time	t <sub>RR</sub>	—	—	5.0	ns	I <sub>F</sub> = I <sub>R</sub> = 10mA, I <sub>RR</sub> = 0.1I <sub>R</sub> , R <sub>L</sub> = 100Ω

Notes: 6. Mounted on FR-4 PC board with recommended pad layout which can be found on our website at <http://www.diodes.com/package-outlines.html>.  
7. Short duration pulse test used to minimize self-heating effect.

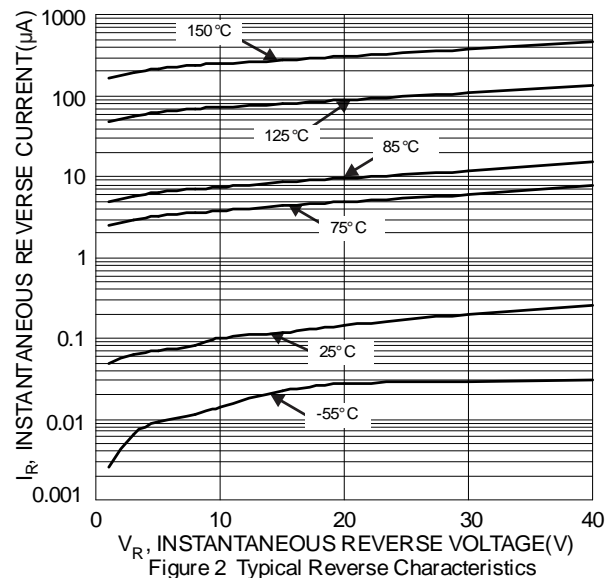
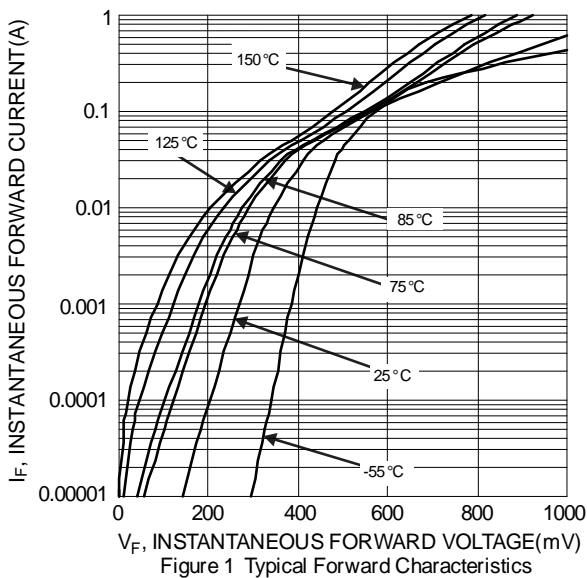

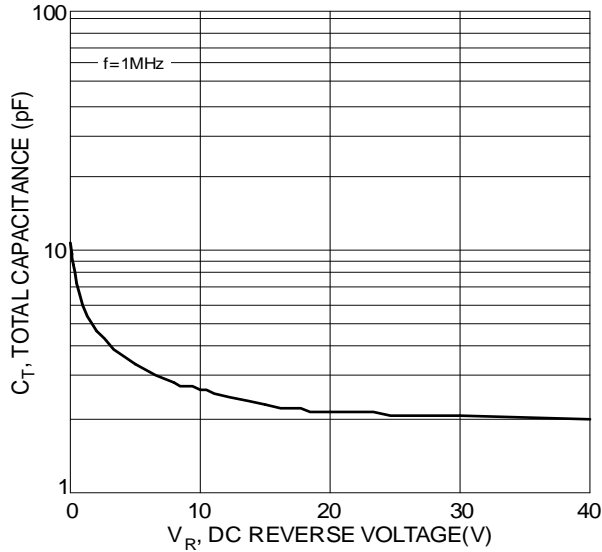

Figure 3 Total Capacitance vs. Reverse Voltage

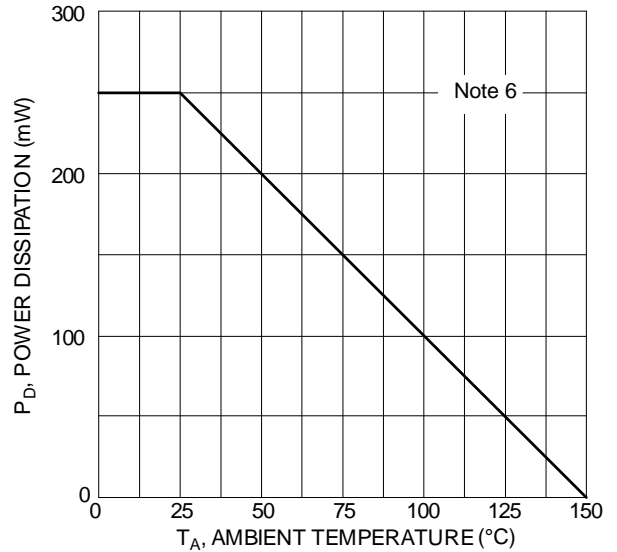
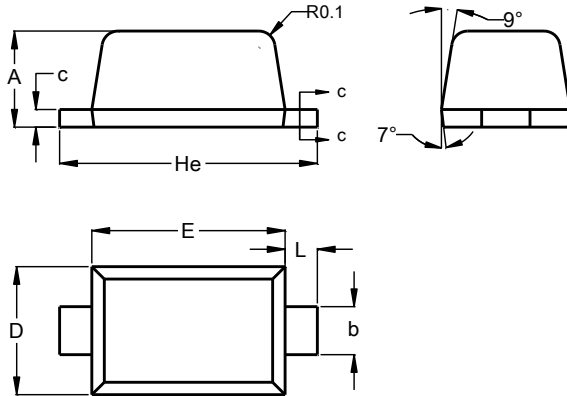

Figure 4 Power Derating Curve

## Package Outline Dimensions

Please see <http://www.diodes.com/package-outlines.html> for the latest version.

### SOD523



SOD523		
Dim	Min	Max
A	0.55	0.65
b	0.26	0.34
c	0.11	0.17
D	0.75	0.85
E	1.15	1.25
He	1.55	1.65
L	0.10	0.30
All Dimensions in mm		

## Suggested Pad Layout

Please see <http://www.diodes.com/package-outlines.html> for the latest version.

### SOD523

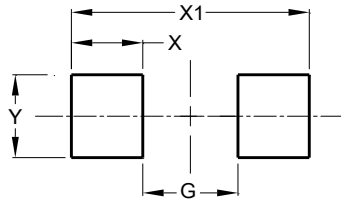

Dimensions	Value (in mm)
<b>G</b>	0.80
<b>X</b>	0.60
<b>X1</b>	2.00
<b>Y</b>	0.70

#### IMPORTANT NOTICE

DIODES INCORPORATED MAKES NO WARRANTY OF ANY KIND, EXPRESS OR IMPLIED, WITH REGARDS TO THIS DOCUMENT, INCLUDING, BUT NOT LIMITED TO, THE IMPLIED WARRANTIES OF MERCHANTABILITY AND FITNESS FOR A PARTICULAR PURPOSE (AND THEIR EQUIVALENTS UNDER THE LAWS OF ANY JURISDICTION).

Diodes Incorporated and its subsidiaries reserve the right to make modifications, enhancements, improvements, corrections or other changes without further notice to this document and any product described herein. Diodes Incorporated does not assume any liability arising out of the application or use of this document or any product described herein; neither does Diodes Incorporated convey any license under its patent or trademark rights, nor the rights of others. Any Customer or user of this document or products described herein in such applications shall assume all risks of such use and will agree to hold Diodes Incorporated and all the companies whose products are represented on Diodes Incorporated website, harmless against all damages.

Diodes Incorporated does not warrant or accept any liability whatsoever in respect of any products purchased through unauthorized sales channel. Should Customers purchase or use Diodes Incorporated products for any unintended or unauthorized application, Customers shall indemnify and hold Diodes Incorporated and its representatives harmless against all claims, damages, expenses, and attorney fees arising out of, directly or indirectly, any claim of personal injury or death associated with such unintended or unauthorized application.

Products described herein may be covered by one or more United States, international or foreign patents pending. Product names and markings noted herein may also be covered by one or more United States, international or foreign trademarks.

This document is written in English but may be translated into multiple languages for reference. Only the English version of this document is the final and determinative format released by Diodes Incorporated.

#### LIFE SUPPORT

Diodes Incorporated products are specifically not authorized for use as critical components in life support devices or systems without the express written approval of the Chief Executive Officer of Diodes Incorporated. As used herein:

A. Life support devices or systems are devices or systems which:

1. are intended to implant into the body, or
2. support or sustain life and whose failure to perform when properly used in accordance with instructions for use provided in the labeling can be reasonably expected to result in significant injury to the user.

B. A critical component is any component in a life support device or system whose failure to perform can be reasonably expected to cause the failure of the life support device or to affect its safety or effectiveness.

Customers represent that they have all necessary expertise in the safety and regulatory ramifications of their life support devices or systems, and acknowledge and agree that they are solely responsible for all legal, regulatory and safety-related requirements concerning their products and any use of Diodes Incorporated products in such safety-critical, life support devices or systems, notwithstanding any devices- or systems-related information or support that may be provided by Diodes Incorporated. Further, Customers must fully indemnify Diodes Incorporated and its representatives against any damages arising out of the use of Diodes Incorporated products in such safety-critical, life support devices or systems.

Copyright © 2019, Diodes Incorporated

[www.diodes.com](http://www.diodes.com)

单击下面可查看定价，库存，交付和生命周期等信息

[>>Diodes Incorporated\(达达科技\(美台\)\)](#)