

Description

The AP7347DQ is a low dropout regulator with high output voltage accuracy, low $R_{DS(on)}$, high PSRR, low output noise, and low quiescent current. This regulator is based on a CMOS process.

The AP7347DQ includes a voltage reference, error amplifier, current limit circuit, and an enable input to turn it on and off. With the integrated resistor network, fixed output voltage versions can be delivered.

With its low power consumption and line and load transient response, the AP7347DQ is well-suited for low power handheld automotive equipment.

The AP7347DQ is packaged in the SOT25 (Type A1) and WDFN2020-6 (wettable) packages, which allow for the smallest footprint and a dense PCB layout.

Pin Assignments

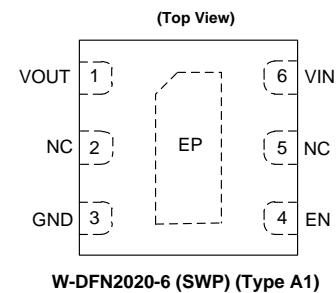
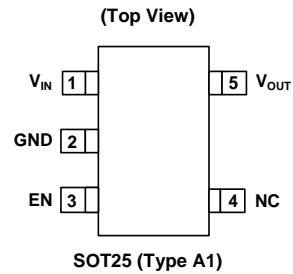

Features

- Low V_{IN} and Wide V_{IN} Range: 1.7V to 5.5V
- Guarantee Output Current: 500mA
- V_{OUT} Accuracy $\pm 1\%$
- Ripple Rejection 75dB at 1kHz
- Low Output Noise, $60\mu V_{rms}$ from 10Hz to 100kHz
- Quiescent Current as Low as $60\mu A$
- V_{OUT} Fixed 1.0V to 5.0V
- **Totally Lead-Free & Fully RoHS Compliant (Notes 1 & 2)**
- **Halogen and Antimony Free. "Green" Device (Note 3)**
- **The AP7347DQ is suitable for automotive applications requiring specific change control; this part is AEC-Q100 qualified, PPAP capable, and manufactured in IATF 16949 certified facilities.**

<https://www.diodes.com/quality/product-definitions/>

Applications

- Infotainment power supplies
- Automotive RF supplies
- Cameras
- Automotive POL in ADAS
- Automotive wireless communication systems

- Notes:
1. No purposely added lead. Fully EU Directive 2002/95/EC (RoHS), 2011/65/EU (RoHS 2) & 2015/863/EU (RoHS 3) compliant.
 2. See <https://www.diodes.com/quality/lead-free/> for more information about Diodes Incorporated's definitions of Halogen- and Antimony-free, "Green" and Lead-free.
 3. Halogen- and Antimony-free "Green" products are defined as those which contain <900ppm bromine, <900ppm chlorine (<1500ppm total Br + Cl) and <1000ppm antimony compounds.

Typical Applications Circuit

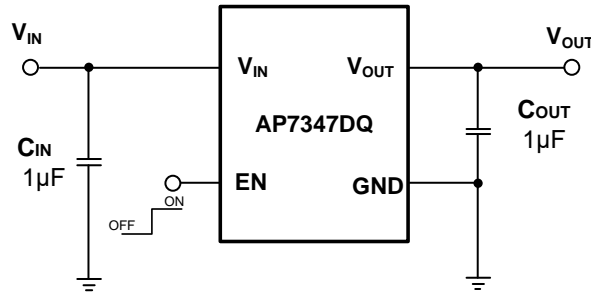

Pin Descriptions

Pin Number		Pin Name	Function
SOT25 (Type A1)	DFN2020-6 (wetttable)		
1	6	V _{IN}	Power Input Pin
2	3	GND	Ground
3	4	EN	Enable Pin This pin should be driven either high or low and must not be floating. Driving this pin high enables the regulator, while pulling it low puts the regulator into shutdown mode
4	2, 5	NC	No Connect Not connected internally; recommended to connect to GND to maximize PCB copper for thermal dissipation.
5	1	V _{OUT}	Power Output Pin
-	EP	Expose Pad	In PCB layout, prefer to use large copper area to cover this pad for better thermal dissipation, then connect this area to GND or leave it open. However, do not use it as GND electrode function alone

Functional Block Diagram

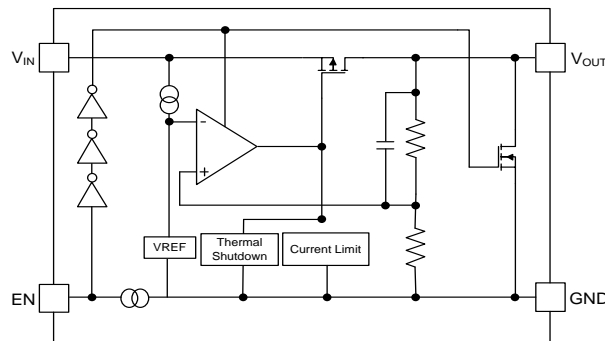

AP7347DQ (With Discharge)

Absolute Maximum Ratings (Note 4) (@ $T_A = +25^\circ\text{C}$, unless otherwise specified.)

Symbol	Parameter	Ratings	Unit
ESD HBM	Human Body Mode ESD Protection	> 2	KV
ESD CDM	Charge Device Model	± 500	V
V_{IN}	Input Voltage	6.0	V
V_{EN}	Input Voltage for EN Pin	6.0	V
V_{OUT}	Output Voltage	-0.3 to $V_{IN} + 0.3$	V
I_{OUT}	Output Current	500	mA
P_D	Power Dissipation	SOT25 (Type A1)	0.89
		WDFN2020-6 (wetable)	2.3
T_A	Operating Ambient Temperature	-40 to +125	$^\circ\text{C}$
T_j	Operating Junction Temperature	-40 to +150	$^\circ\text{C}$
T_{STG}	Storage Temperature	-55 to +150	$^\circ\text{C}$

Note: 4. a). Stresses beyond those listed under Absolute Maximum Ratings may cause permanent damage to the device. These are stress ratings only and functional operation of the device at these conditions is not implied. Exposure to absolute-maximum-rated conditions for extended period may affect device reliability.
 b). Ratings apply to ambient temperature at +25°C. The JEDEC STD.51 High-K board design used to derive this data was a 3 inch x 3 inch multilayer board with 1oz. internal power and ground planes and 2oz. copper traces on the top and bottom of the board.

Recommended Operating Conditions (@ $T_A = +25^\circ\text{C}$, unless otherwise specified.)

Symbol	Parameter	Min	Max	Unit
V_{IN}	Input Voltage	1.7	5.5	V
I_{OUT}	Output Current	0	500	mA
T_j	Operating Junction Temperature	-40	+125	$^\circ\text{C}$

Electrical Characteristics (@ $T_J = -40^{\circ}\text{C} \sim +125^{\circ}\text{C}$, $V_{IN} = V_{OUT} + 1.0\text{V}$ or $V_{IN} = V_{OUT} + 0.5$ (if $V_{OUT} > 4.5\text{V}$) $C_{IN} = C_{OUT} = 1.0\mu\text{F}$, $I_{OUT} = 1.0\text{mA}$, unless otherwise specified.)

Parameter	Condition	Min	Typ	Max	Units	
Input Voltage	$T_J = -40^{\circ}\text{C}$ to $+125^{\circ}\text{C}$	1.7	—	5.5	V	
Output Voltage Accuracy (Note 10)	$V_{OUT}(T) \geq 2.0\text{V}$, $V_{IN} = V_{OUT}(T) + 1\text{V}$ or $V_{IN} = V_{OUT} + 0.5$ (if $V_{OUT} > 4.5\text{V}$)	$V_{OUT}(T)^* 0.99$	$V_{OUT}(T)$	$V_{OUT}(T)^* 1.01$	V	
	$V_{OUT}(T) < 2.0\text{V}$, $V_{IN} = V_{OUT}(T) + 1\text{V}$	$V_{OUT}(T) - 20\text{mV}$	$V_{OUT}(T)$	$V_{OUT}(T) + 20\text{mV}$		
Line Regulation ($dV_{OUT}/dV_{IN}/V_{OUT}$)	$V_{IN} = (V_{OUT-Nom} + 1.0\text{V})$ to 5.5V , $I_{OUT} = 1.0\text{mA}$, $V_{IN} = 5.3$ to 5.5V (if $V_{OUT} = 5.5\text{V}$)	—	0.02	0.1	%/V	
Load Regulation	$V_{IN} = V_{OUT-Nom} + 1.0\text{V}$, $I_{OUT} = 1\text{mA}$ to 500mA	—	22.5	45	mV	
Quiescent Current (Note 6)	$I_{OUT} = 0\text{mA}$	—	60	125	μA	
$I_{STANDBY}$	$V_{EN} = 0\text{V}$ (Disabled)	—	0.01	1.0	μA	
Output Current	$V_{IN} > V_{OUT} + \text{max Dropout}$, and $V_{IN} > 2.0\text{V}$	500	—	—	mA	
Fold-back Short Current (Note 7)	V_{OUT} Short to Ground	—	180	—	mA	
PSRR (Note 8)	$V_{IN} = (V_{OUT} + 1\text{V}) V_{DC} + 0.2\text{Vp-pAC}$, $V_{OUT} = 1.0\text{V}$, $I_{OUT} = 50\text{mA}$ $f = 1\text{kHz}$	—	75	—	dB	
Output Noise Voltage (Note 8) (Note 9)	$BW = 10\text{Hz}$ to 100kHz , $V_{OUT} = 1.0\text{V}$, $I_{OUT} = 50\text{mA}$	—	60	—	μVrms	
Dropout Voltage (Note 5)	$I_{OUT} = 500\text{mA}$	$1.0\text{V} \leq V_{OUT} < 1.2\text{V}$	—	0.75	0.95	V
		$1.2\text{V} \leq V_{OUT} < 1.4\text{V}$	—	0.65	0.80	
		$1.4\text{V} \leq V_{OUT} < 1.7\text{V}$	—	0.55	0.66	
		$1.7\text{V} \leq V_{OUT} < 2.1\text{V}$	—	0.45	0.55	
		$2.1\text{V} \leq V_{OUT} < 2.5\text{V}$	—	0.36	0.42	
		$2.5\text{V} \leq V_{OUT} < 3.0\text{V}$	—	0.31	0.36	
		$3.0\text{V} \leq V_{OUT} < 4.0\text{V}$	—	0.27	0.32	
Output Voltage Temperature Coefficient	$I_{OUT} = 50\text{mA}$, $T_J = -40^{\circ}\text{C}$ to $+125^{\circ}\text{C}$	—	± 30	—	ppm/ $^{\circ}\text{C}$	
Thermal Shutdown Threshold (TSHDN)	—	—	+170	—	$^{\circ}\text{C}$	
Thermal Shutdown Hysteresis (THYS)	—	—	+20	—	$^{\circ}\text{C}$	
EN Input Low Voltage	—	0	—	0.5	V	
EN Input High Voltage	—	1.25	—	5.5	V	
EN Input Leakage	$V_{EN} = 0$, $V_{IN} = 5.0\text{V}$ or $V_{EN} = 5.0\text{V}$, $V_{IN} = 0\text{V}$	-1	—	+1	μA	
On Resistance of N-Channel for Auto-Discharge (Note 10)	$V_{IN} = 4.0\text{V}$, $V_{EN} = 0\text{V}$ (Disabled)	—	30	—	Ω	
Thermal Resistance Junction to Ambient (θ_{JA})	SOT25 (Type A1)	—	140	—	$^{\circ}\text{C}/\text{W}$	
	WDFN2020-6 (Wettable)	—	54	—		
Thermal Resistance Junction to Case (θ_{JC})	SOT25 (Type A1)	—	57	—	$^{\circ}\text{C}/\text{W}$	
	WDFN2020-6 (Wettable)	—	20	—		

- Notes:
- Dropout voltage is the voltage difference between the input and the output at which the output voltage drops 2% below its nominal value.
 - Quiescent current is defined here is the difference in current between the input and the output.
 - Short-circuit current is measured with V_{OUT} pulled to GND.
 - This specification is guaranteed by design.
 - To make sure lowest environment noise minimizes the influence on noise measurement.
 - Potential multiple grades based on following output voltage accuracy.

Typical Characteristics ($C_{IN} = C_{OUT} = 1\mu F$)

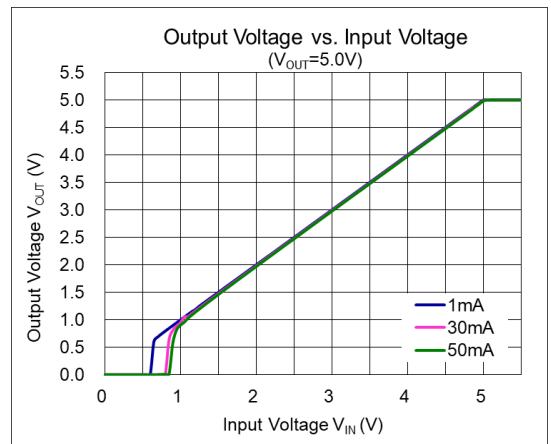
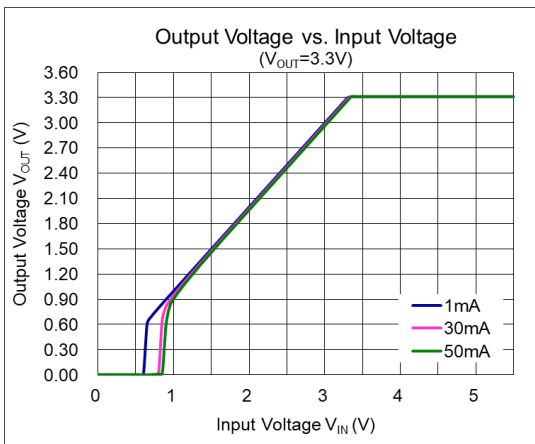
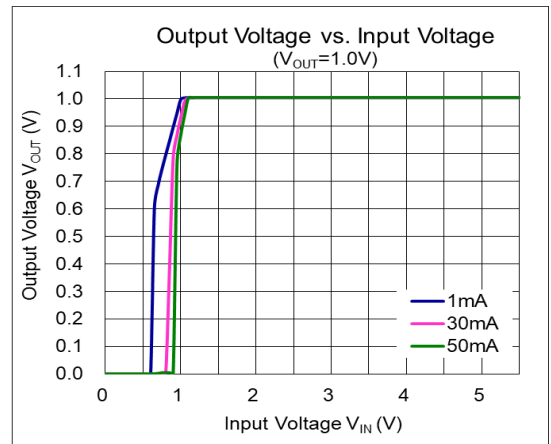
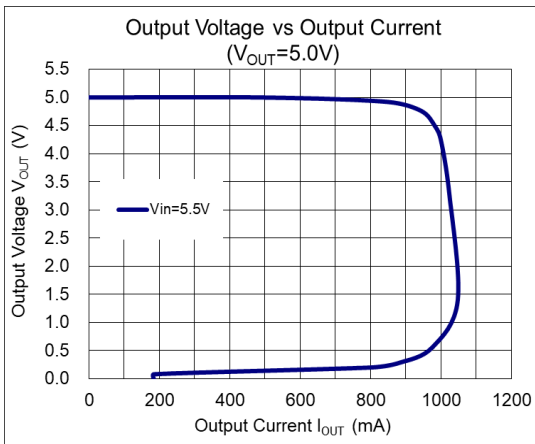
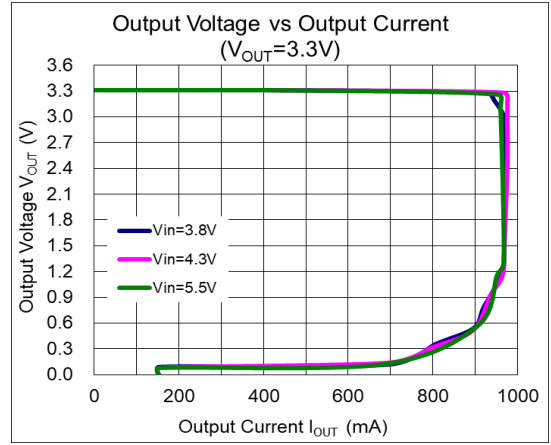
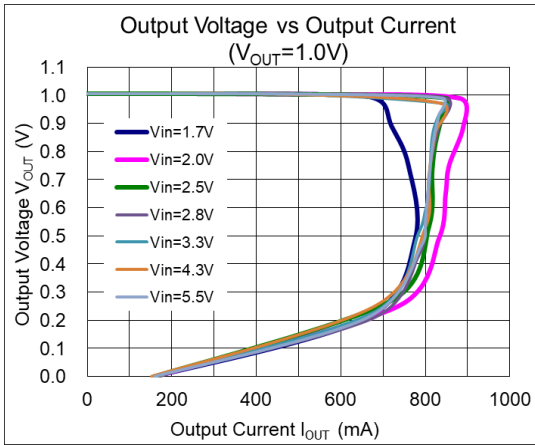

Typical Characteristics ($C_{IN} = C_{OUT} = 1\mu F$) (continued)

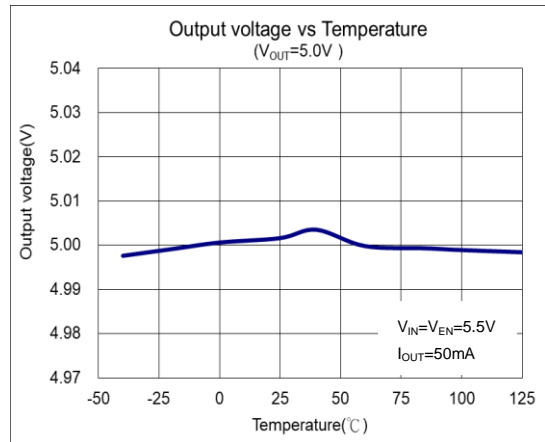
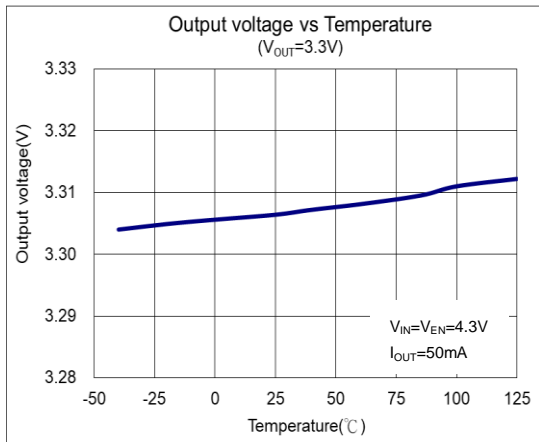
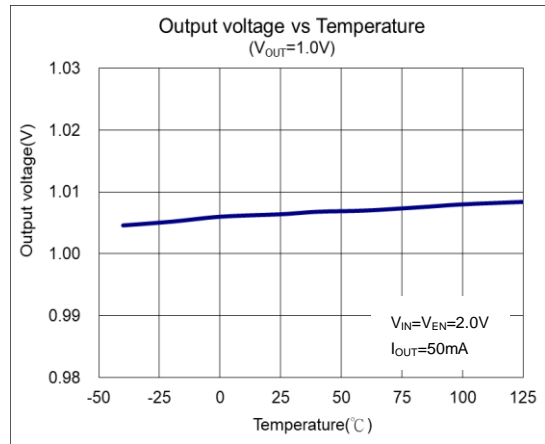
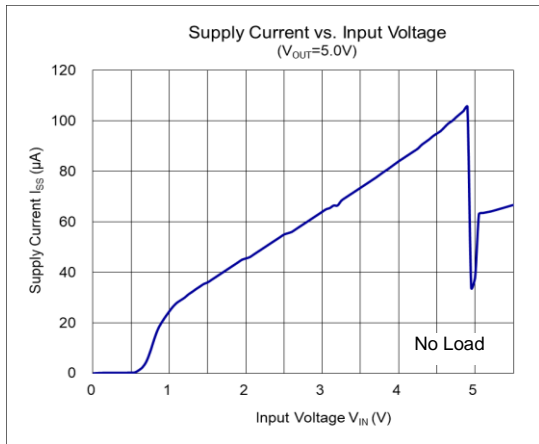
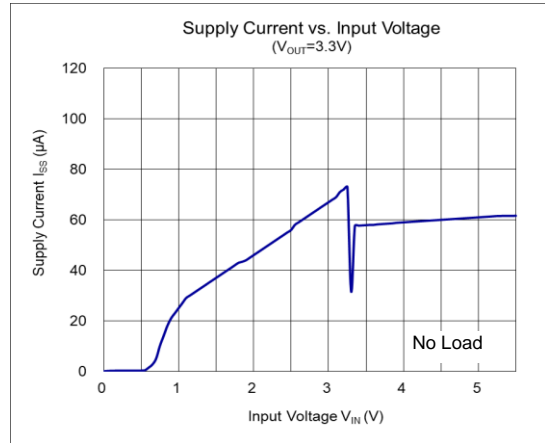
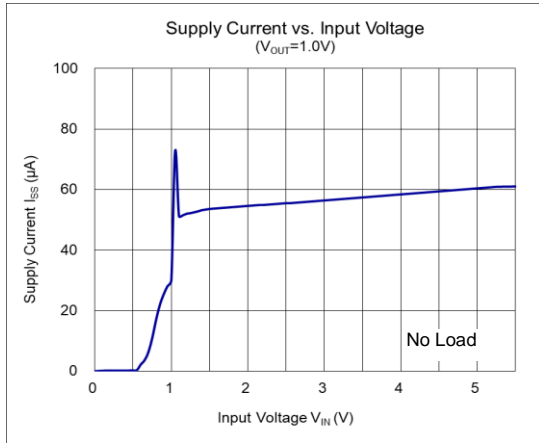

Typical Characteristics ($C_{IN} = C_{OUT} = 1\mu F$) (continued)

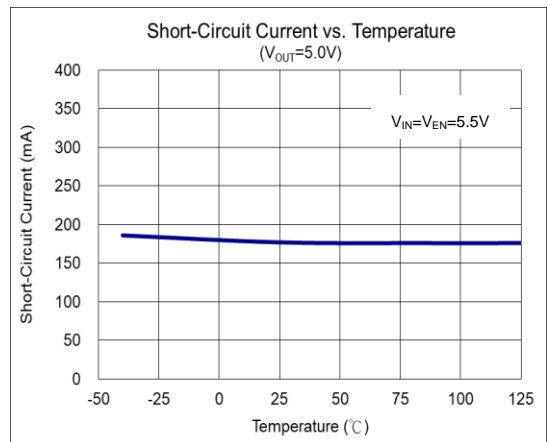
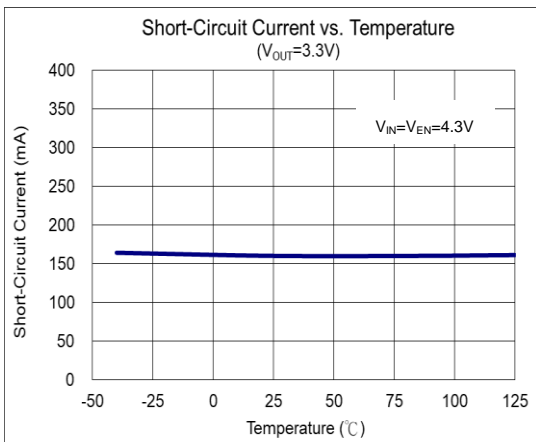
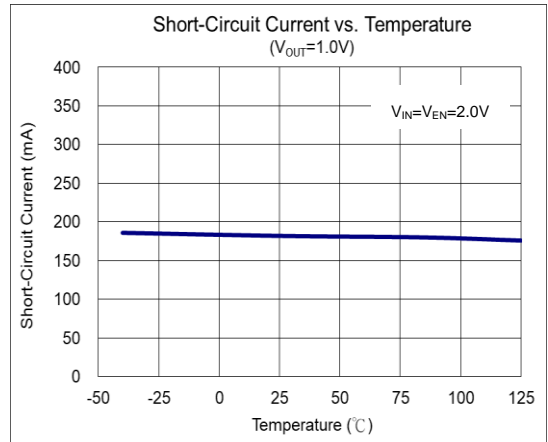
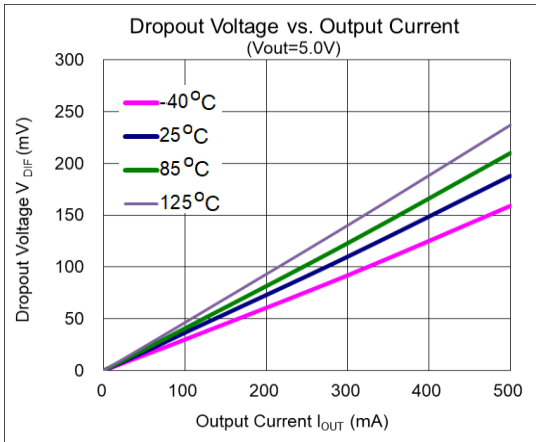
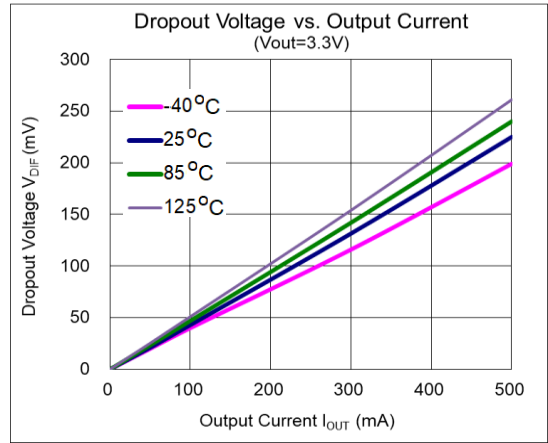
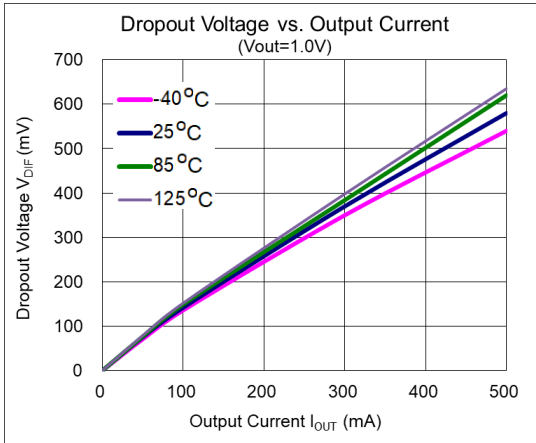

Typical Characteristics ($C_{IN} = C_{OUT} = 1\mu F$) (continued)

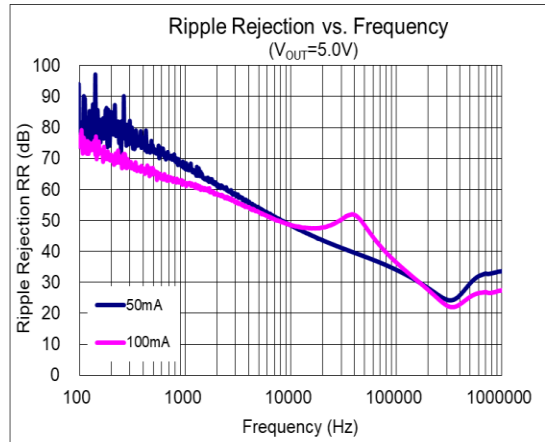
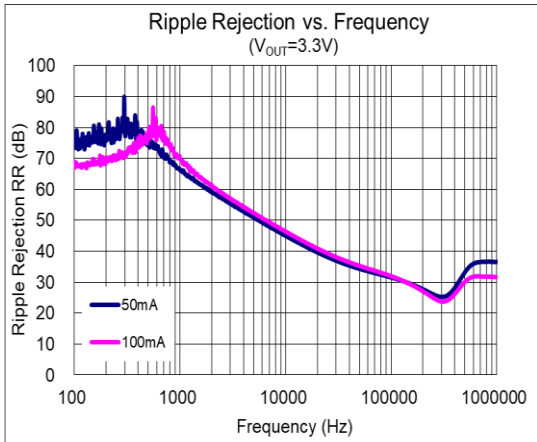
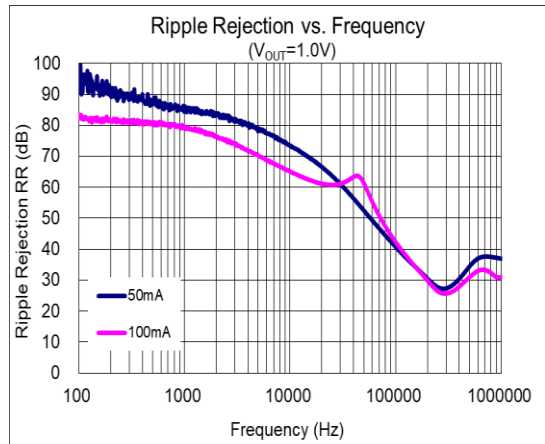
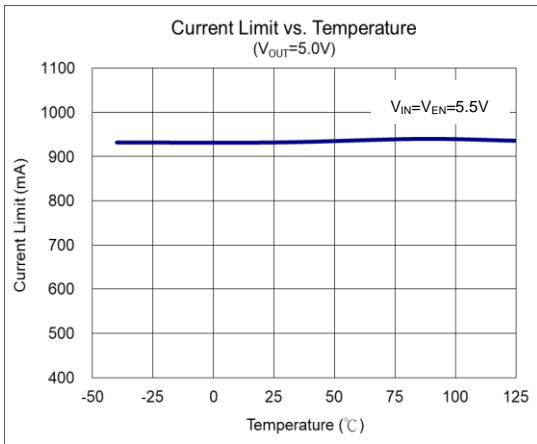
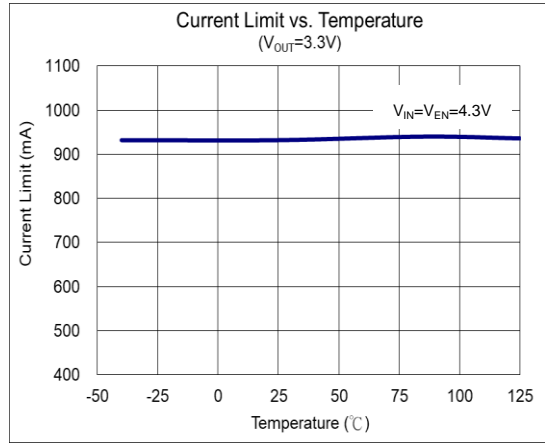
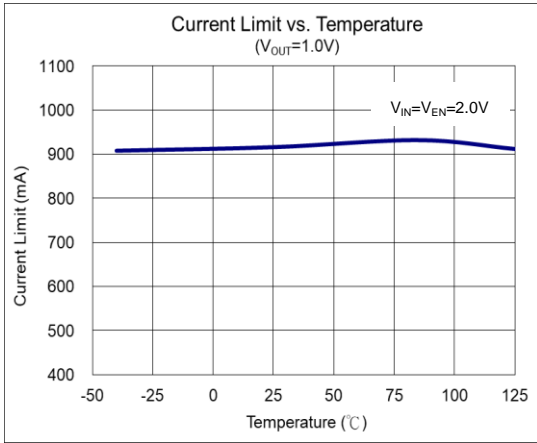

Typical Characteristics ($C_{IN} = C_{OUT} = 1\mu F$) (continued)

Enable Turn-On Response
($V_{OUT}=1.0V$)

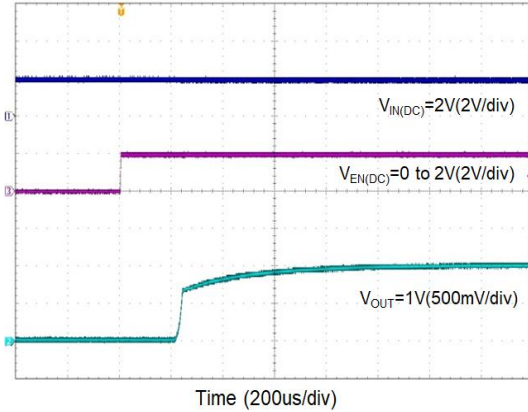

Enable Turn-On Response
($V_{OUT}=3.3V$)

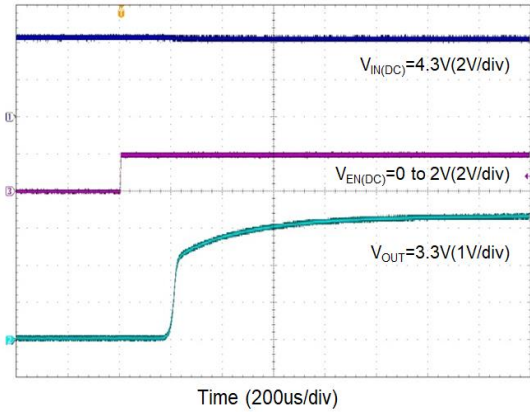

Enable Turn-On Response
($V_{OUT}=5.0V$)

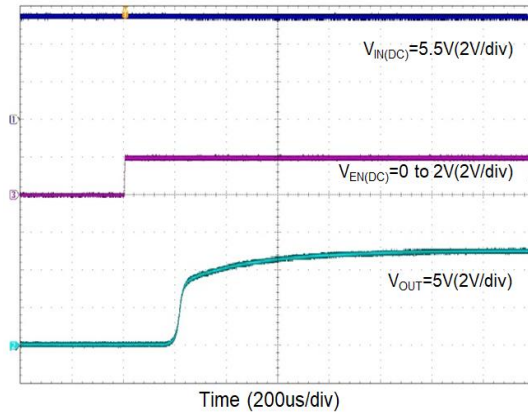

Enable Turn-Off Response
($V_{OUT}=1.0V$)

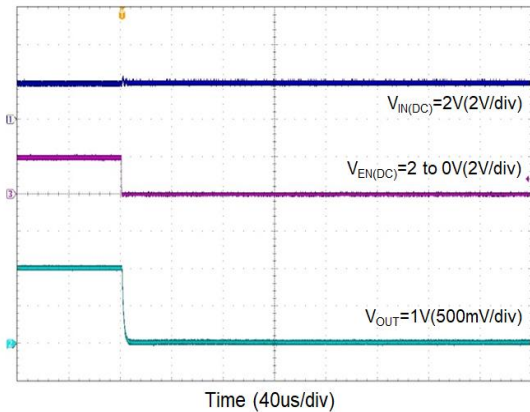

Enable Turn-Off Response
($V_{OUT}=3.3V$)

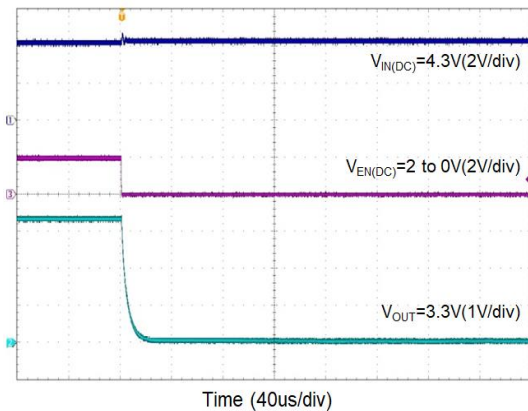

Enable Turn-Off Response
($V_{OUT}=5.0V$)

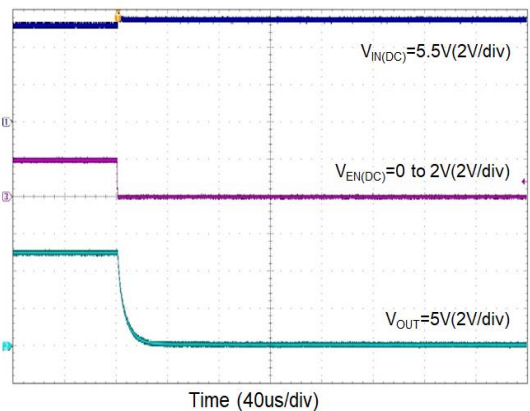

Typical Characteristics ($C_{IN} = C_{OUT} = 1\mu F$) (continued)

Line Transient Response
($V_{OUT}=1.2V$)

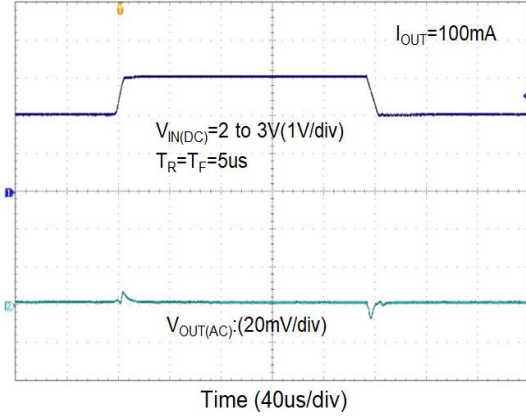

Line Transient Response
($V_{OUT}=3.3V$)

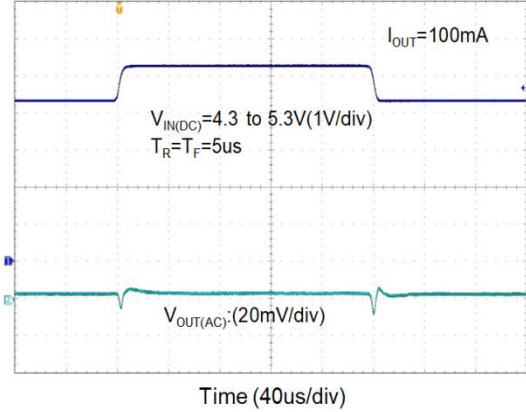

Line Transient Response
($V_{OUT}=5.0V$)

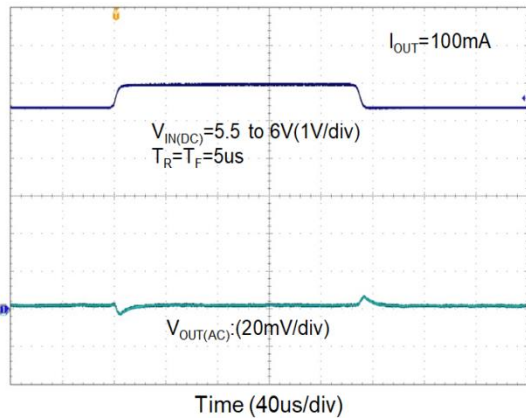

Load Transient Response
($V_{OUT}=1.0V$)

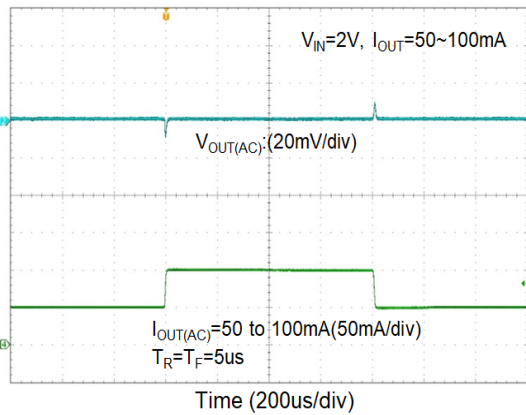

Load Transient Response
($V_{OUT}=3.3V$)

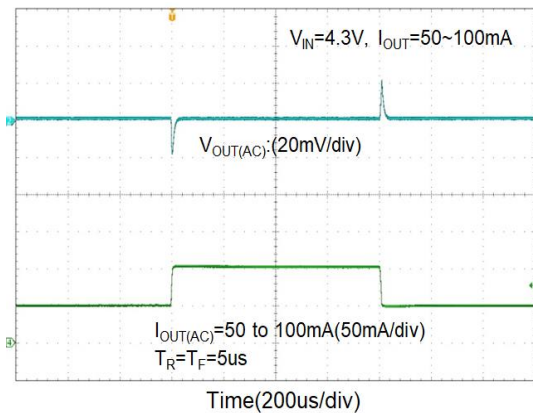

Load Transient Response
($V_{OUT}=5.0V$)

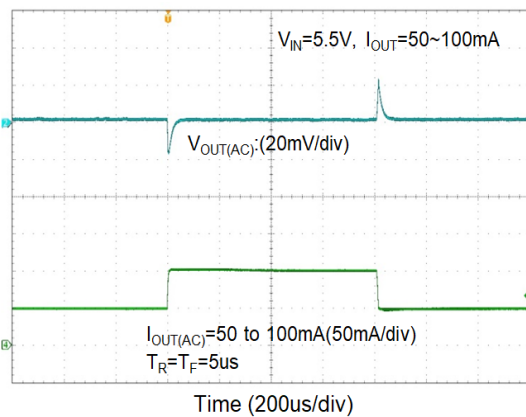

Typical Characteristics ($C_{IN} = C_{OUT} = 1\mu F$) (continued)

Load Transient Response
($V_{OUT}=1.0V$)

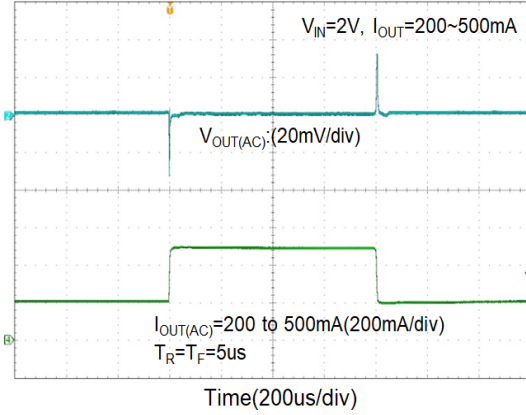

Load Transient Response
($V_{OUT}=3.3V$)

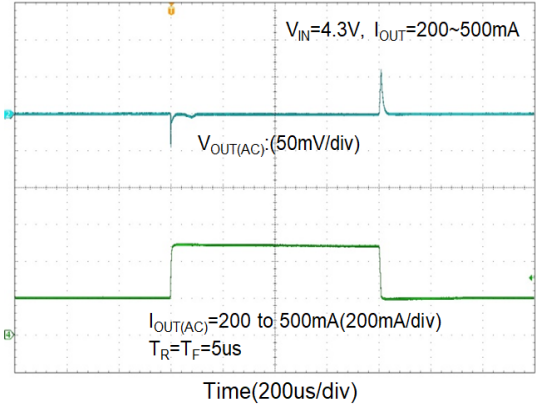

Load Transient Response
($V_{OUT}=3.3V$)

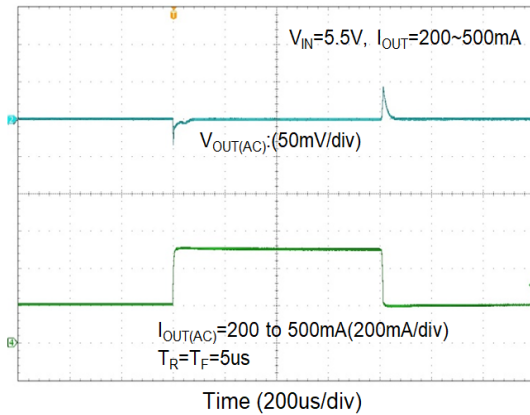

Application Information

Output Capacitor

An output capacitor (C_{OUT}) is needed to improve transient response and maintain stability. The AP7347DQ is stable with very small ceramic output capacitors. The ESR (equivalent series resistance) and capacitance drives the selection. If the application has large load variations, it is recommended to utilize low-ESR bulk capacitors. It is also recommended to place ceramic capacitors as close as possible to the load and the ground pin. Care should be taken to reduce the impedance in the layout.

Input Capacitor

To prevent the input voltage from dropping during load steps, it is recommended to utilize an input capacitor (C_{IN}). A minimum $1\mu\text{F}$ ceramic capacitor is recommended between the V_{IN} and GND pins to decouple input power supply glitch. This input capacitor must be located as close as possible to the device to assure input stability and reduce noise. For PCB layout, a wide copper trace is required for both V_{IN} and GND pins.

Enable Control

The AP7347DQ is turned on by setting the EN pin high, and is turned off by pulling it low. If this feature is not used, the EN pin should be tied to V_{IN} pin to keep the regulator output on at all times. To ensure proper operation, the signal source used to drive the EN pin must be able to swing above and below the specified turn-on/off voltage thresholds listed in the Electrical Characteristics section.

Short-Circuit Protection

When the V_{OUT} pin short-circuits to GND, short-circuit protection will be triggered and clamp the output current to approximately 55mA. This feature protects the regulator from overcurrent and damage due to overheating.

Layout Considerations

For good ground loop and stability, the input and output capacitors should be located close to the input, output, and ground pins of the device. The regulator ground pin should be connected to the external circuit ground to reduce voltage drop caused by trace impedance. Ground plane is generally used to reduce trace impedance. Wide trace should be used for large current paths from V_{IN} to V_{OUT} , and load circuit.

ESR vs. Output Current

A ceramic type output capacitor is recommended for this series; however, other output capacitors with low ESR can also be used. The relationship between the I_{OUT} (output current) and the ESR of an output capacitor are shown below. The stable region for the safe operating temperature ($-40^{\circ}\text{C} \sim +85^{\circ}\text{C}$) is marked as the gray area in the graph.

Measurement conditions: Frequency Band: 10Hz to 2MHz, Temperature: -40°C to $+85^{\circ}\text{C}$.

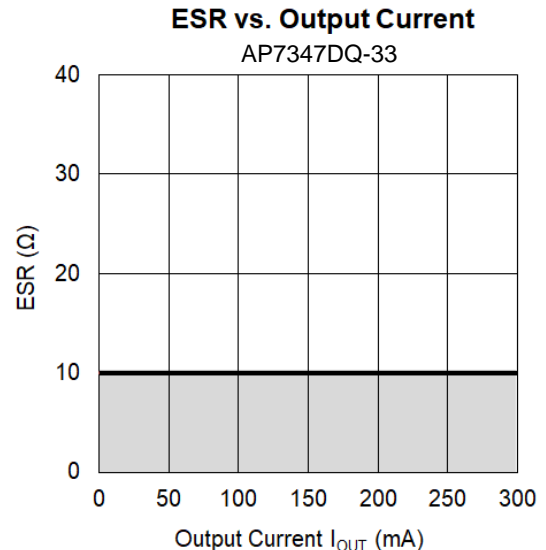
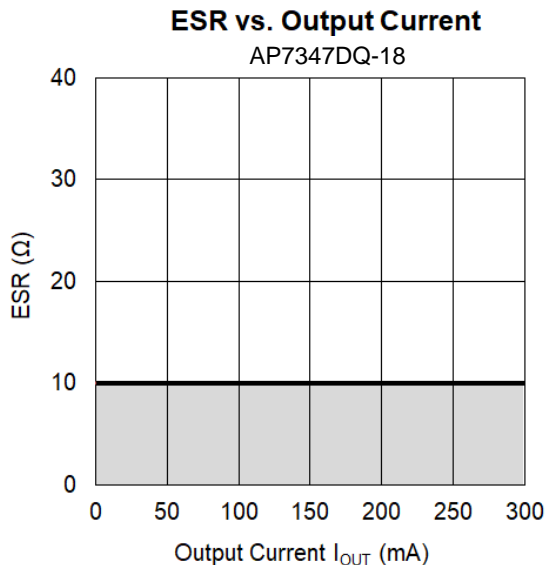

Ordering Information (Note 11)

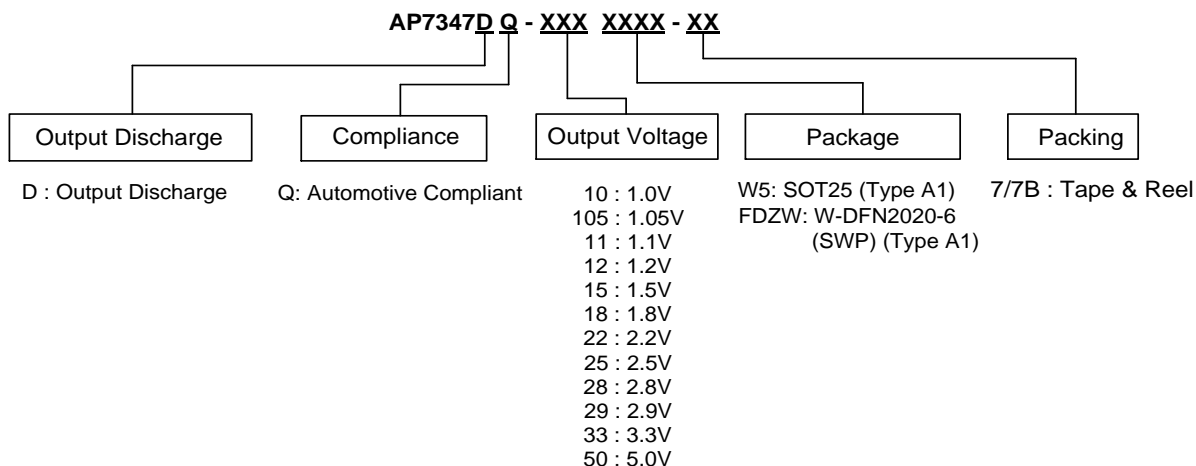

Part Number	Package Code	Packaging	7" Tape and Reel	
			Quantity	Part Number Suffix
AP7347DQ-XXXW5-7	W5	SOT25 (Type A1)	3000/Tape & Reel	-7
AP7347DQ-XXXFDZW-7	FDZW	W-DFN2020-6 (SWP) (Type A1)	3000/Tape & Reel	-7
AP7347DQ-XXXFDZW-7B	FDZW	W-DFN2020-6 (SWP) (Type A1)	3000/Tape & Reel	-7B

Note: 11. For packaging details, go to our website at <http://www.diodes.com/products/packages.html>.

Marking Information

(1) SOT25 (Type A1)

(Top View)

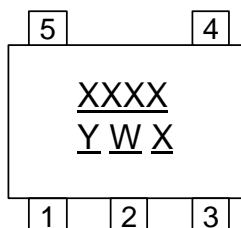

XXXX : Identification Code

Y : Year 0 to 9

W : Week : A to Z : 1 to 26 week;
 a to z : 27 to 52 week; z represents
 52 and 53 week

X : Internal Code

Part Number	Package	Identification Code
AP7347DQ-10W5-7	SOT25	J7AQ
AP7347DQ-105W5-7	SOT25	J7BQ
AP7347DQ-11W5-7 (*)	SOT25	J7CQ
AP7347DQ-12W5-7	SOT25	J7DQ
AP7347DQ-15W5-7 (*)	SOT25	J7EQ
AP7347DQ-18W5-7	SOT25	J7FQ
AP7347DQ-22W5-7 (*)	SOT25	J7GQ
AP7347DQ-25W5-7	SOT25	J7HQ
AP7347DQ-28W5-7	SOT25	J7JQ
AP7347DQ-29W5-7 (*)	SOT25	J7KQ
AP7347DQ-33W5-7	SOT25	J7MQ
AP7347DQ-50W5-7	SOT25	J7NQ

* This voltage is supported upon request.

Marking Information (continued)

(2) W-DFN2020-6 (SWP) (Type A1)

(Top View)

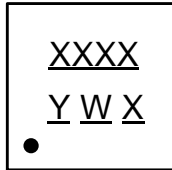

XXXX : Identification Code

Y : Year : 0~9

W : Week : A~Z : 1~26 week;
a~z : 27~52 week; z represents
52 and 53 week

X : Internal Code

Part Number	Package	Identification Code
AP7347DQ-10FDZW-7	W-DFN2020-6 (SWP) (Type A1)	J7AQ
AP7347DQ-105FDZW-7	W-DFN2020-6 (SWP) (Type A1)	J7BQ
AP7347DQ-11FDZW-7 (*)	W-DFN2020-6 (SWP) (Type A1)	J7CQ
AP7347DQ-12FDZW-7	W-DFN2020-6 (SWP) (Type A1)	J7DQ
AP7347DQ-15FDZW-7 (*)	W-DFN2020-6 (SWP) (Type A1)	J7EQ
AP7347DQ-18FDZW-7	W-DFN2020-6 (SWP) (Type A1)	J7FQ
AP7347DQ-22FDZW-7 (*)	W-DFN2020-6 (SWP) (Type A1)	J7GQ
AP7347DQ-25FDZW-7	W-DFN2020-6 (SWP) (Type A1)	J7HQ
AP7347DQ-28FDZW-7	W-DFN2020-6 (SWP) (Type A1)	J7JQ
AP7347DQ-29FDZW-7 (*)	W-DFN2020-6 (SWP) (Type A1)	J7KQ
AP7347DQ-33FDZW-7	W-DFN2020-6 (SWP) (Type A1)	J7MQ
AP7347DQ-50FDZW-7	W-DFN2020-6 (SWP) (Type A1)	J7NQ

* This voltage is supported upon request.

Part Number	Package	Identification Code
AP7347DQ-10FDZW-7B	W-DFN2020-6 (SWP) (Type A1)	J7AQ
AP7347DQ-105FDZW-7B	W-DFN2020-6 (SWP) (Type A1)	J7BQ
AP7347DQ-11FDZW-7B (*)	W-DFN2020-6 (SWP) (Type A1)	J7CQ
AP7347DQ-12FDZW-7B	W-DFN2020-6 (SWP) (Type A1)	J7DQ
AP7347DQ-15FDZW-7B (*)	W-DFN2020-6 (SWP) (Type A1)	J7EQ
AP7347DQ-18FDZW-7B	W-DFN2020-6 (SWP) (Type A1)	J7FQ
AP7347DQ-22FDZW-7B (*)	W-DFN2020-6 (SWP) (Type A1)	J7GQ
AP7347DQ-25FDZW-7B	W-DFN2020-6 (SWP) (Type A1)	J7HQ
AP7347DQ-28FDZW-7B	W-DFN2020-6 (SWP) (Type A1)	J7JQ
AP7347DQ-29FDZW-7B (*)	W-DFN2020-6 (SWP) (Type A1)	J7KQ
AP7347DQ-33FDZW-7B	W-DFN2020-6 (SWP) (Type A1)	J7MQ
AP7347DQ-50FDZW-7B	W-DFN2020-6 (SWP) (Type A1)	J7NQ

* This voltage is supported upon request.

Package Outline Dimensions

Please see <http://www.diodes.com/package-outlines.html> for the latest version.

(1) SOT25 (Type A1)

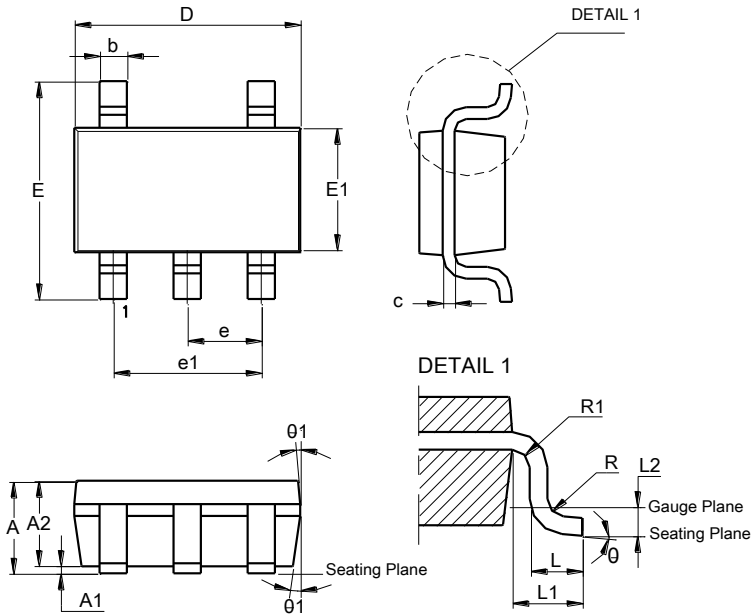

SOT25 (Type A1)			
Dim	Min	Max	Typ
A	--	1.45	--
A1	0.00	0.15	--
A2	0.90	1.30	1.15
b	0.30	0.50	--
c	0.08	0.22	--
D	2.90 BSC		
E	2.80 BSC		
E1	1.60 BSC		
e	0.95 BSC		
e1	1.90 BSC		
L	0.30	0.60	0.45
L1	0.60 REF		
L2	0.25 BSC		
R	0.10	--	--
R1	0.10	0.25	--
theta	0°	8°	4°
theta1	5°	15°	10°
All Dimensions in mm			

(2) W-DFN2020-6 (SWP) (Type A1)

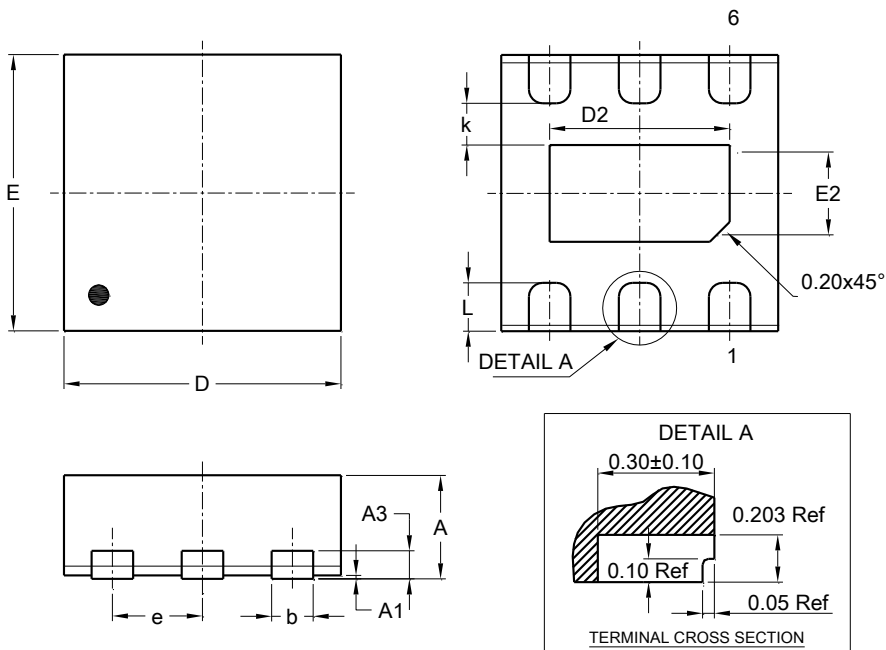

W-DFN2020-6 (SWP) (Type A1)			
Dim	Min	Max	Typ
A	0.70	0.80	0.75
A1	0.00	0.05	0.02
A2	0.203 REF		
b	0.25	0.35	0.30
D	2.00 BSC		
D2	1.35	1.45	1.40
E	2.00 BSC		
E2	0.55	0.65	0.60
e	0.65 BSC		
k	0.20	--	--
L	0.20	0.40	0.30
All Dimensions in mm			

Suggested Pad Layout

Please see <http://www.diodes.com/package-outlines.html> for the latest version.

(1) **SOT25 (Type A1)**

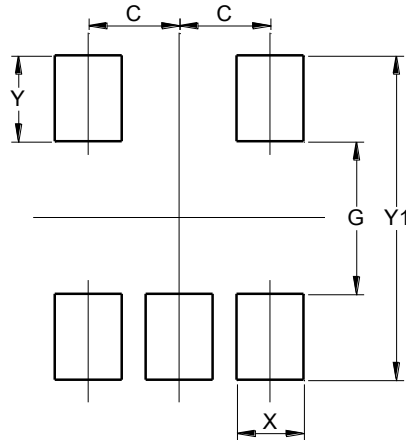

Dimensions	Value (in mm)
C	0.950
G	1.600
X	0.700
Y	0.900
Y1	3.400

(2) **W-DFN2020-6 (SWP) (Type A1)**

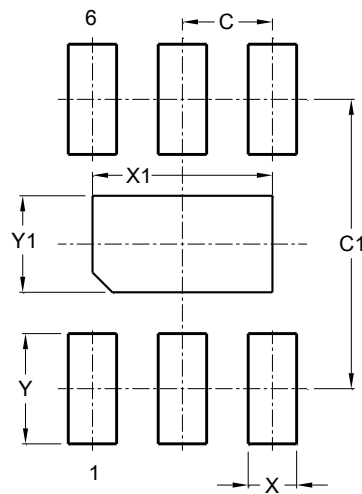

Dimensions	Value (in mm)
C	0.650
C1	2.100
X	0.350
X1	1.400
Y	0.800
Y1	0.600

Mechanical Data

- Moisture Sensitivity: Level 1 Per J-STD-020
- Terminals: Finish - Matte Tin Plated Leads, Solderable per MIL-STD-202, Method 208 ③
- Weight:
 - SOT25: 0.016 grams (Approximate)
 - W-DFN2020-6: 0.010 grams (Approximate)

Tape Orientation (Note 12)

For AP7347DQ-XXXW5-7

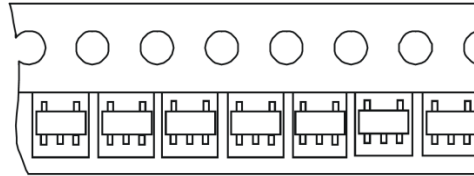

For AP7347DQ-XXXFDZW-7

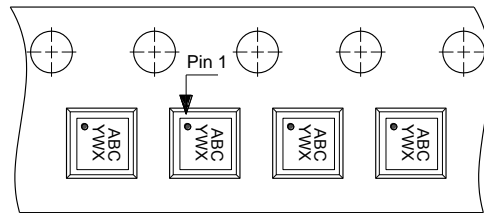

For AP7347DQ-XXXFDZW-7B

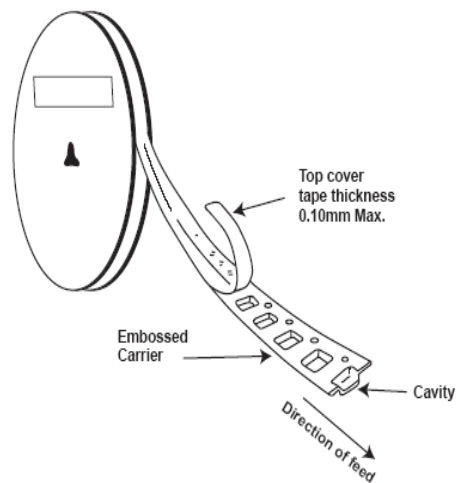
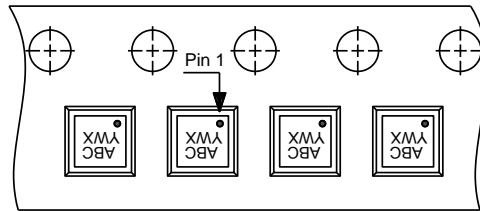

Note: 12. The taping orientation of other package types can be found on our website at <http://www.diodes.com/package-outlines.html>.

IMPORTANT NOTICE

1. DIODES INCORPORATED AND ITS SUBSIDIARIES ("DIODES") MAKE NO WARRANTY OF ANY KIND, EXPRESS OR IMPLIED, WITH REGARDS TO ANY INFORMATION CONTAINED IN THIS DOCUMENT, INCLUDING, BUT NOT LIMITED TO, THE IMPLIED WARRANTIES OF MERCHANTABILITY, FITNESS FOR A PARTICULAR PURPOSE OR NON-INFRINGEMENT OF THIRD PARTY INTELLECTUAL PROPERTY RIGHTS (AND THEIR EQUIVALENTS UNDER THE LAWS OF ANY JURISDICTION).
2. The Information contained herein is for informational purpose only and is provided only to illustrate the operation of Diodes products described herein and application examples. Diodes does not assume any liability arising out of the application or use of this document or any product described herein. This document is intended for skilled and technically trained engineering customers and users who design with Diodes products. Diodes products may be used to facilitate safety-related applications; however, in all instances customers and users are responsible for (a) selecting the appropriate Diodes products for their applications, (b) evaluating the suitability of the Diodes products for their intended applications, (c) ensuring their applications, which incorporate Diodes products, comply the applicable legal and regulatory requirements as well as safety and functional-safety related standards, and (d) ensuring they design with appropriate safeguards (including testing, validation, quality control techniques, redundancy, malfunction prevention, and appropriate treatment for aging degradation) to minimize the risks associated with their applications.
3. Diodes assumes no liability for any application-related information, support, assistance or feedback that may be provided by Diodes from time to time. Any customer or user of this document or products described herein will assume all risks and liabilities associated with such use, and will hold Diodes and all companies whose products are represented herein or on Diodes' websites, harmless against all damages and liabilities.
4. Products described herein may be covered by one or more United States, international or foreign patents and pending patent applications. Product names and markings noted herein may also be covered by one or more United States, international or foreign trademarks and trademark applications. Diodes does not convey any license under any of its intellectual property rights or the rights of any third parties (including third parties whose products and services may be described in this document or on Diodes' website) under this document.
5. Diodes products are provided subject to Diodes' Standard Terms and Conditions of Sale (<https://www.diodes.com/about/company/terms-and-conditions/terms-and-conditions-of-sales/>) or other applicable terms. This document does not alter or expand the applicable warranties provided by Diodes. Diodes does not warrant or accept any liability whatsoever in respect of any products purchased through unauthorized sales channel.
6. Diodes products and technology may not be used for or incorporated into any products or systems whose manufacture, use or sale is prohibited under any applicable laws and regulations. Should customers or users use Diodes products in contravention of any applicable laws or regulations, or for any unintended or unauthorized application, customers and users will (a) be solely responsible for any damages, losses or penalties arising in connection therewith or as a result thereof, and (b) indemnify and hold Diodes and its representatives and agents harmless against any and all claims, damages, expenses, and attorney fees arising out of, directly or indirectly, any claim relating to any noncompliance with the applicable laws and regulations, as well as any unintended or unauthorized application.
7. While efforts have been made to ensure the information contained in this document is accurate, complete and current, it may contain technical inaccuracies, omissions and typographical errors. Diodes does not warrant that information contained in this document is error-free and Diodes is under no obligation to update or otherwise correct this information. Notwithstanding the foregoing, Diodes reserves the right to make modifications, enhancements, improvements, corrections or other changes without further notice to this document and any product described herein. This document is written in English but may be translated into multiple languages for reference. Only the English version of this document is the final and determinative format released by Diodes.
8. Any unauthorized copying, modification, distribution, transmission, display or other use of this document (or any portion hereof) is prohibited. Diodes assumes no responsibility for any losses incurred by the customers or users or any third parties arising from any such unauthorized use.

Copyright © 2021 Diodes Incorporated

www.diodes.com

单击下面可查看定价，库存，交付和生命周期等信息

[>>Diodes Incorporated\(达达科技\(美台\)\)](#)