

Product Summary (@T_A = +25°C)

V _{RRM} (V)	I _O (A)	V _F Max (V)	I _R Max (μA)
400	5	1.185	10

Description

PDU540, a 5.0A Glass Passivated Ultra-Fast Recovery Rectifier in our thermally efficient PowerDI5 package, offers ultra-fast recovery time for high efficiency, high forward surge current for use in high frequency inverters, freewheeling and polarity protection application.

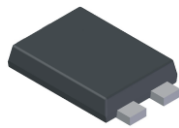

Top View

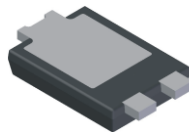

Bottom View

Features and Benefits

- Glass Passivated Die Construction
- Ultra-Fast Recovery Time for High Efficiency
- High Maximum Junction Temperature
- For Use in High Frequency Inverters, Freewheeling and Polarity Protection Applications
- High Forward Surge Current Capability
- **Lead-Free Finish; RoHS Compliant (Notes 1 & 2)**
- **Halogen and Antimony Free. "Green" Device (Note 3)**

Mechanical Data

- Case: PowerDI5
- Case Material: Molded Plastic, "Green" Molding Compound. UL Flammability Classification Rating 94V-0
- Moisture Sensitivity: Level 1 per J-STD-020
- Terminals: Finish – Matte Tin Annealed over Copper Leadframe. Solderable per MIL-STD-202, Method 208 (E3)
- Weight: 0.096 grams (Approximate)

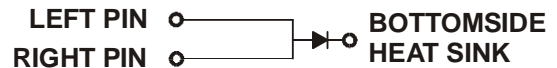

Note: Pins Left & Right must be electrically connected at the printed circuit board.

Ordering Information (Note 4)

Part Number	Compliance	Case	Packaging
PDU540-13	Commercial	PowerDI5	5,000/Tape & Reel

- Notes:
1. EU Directive 2002/95/EC (RoHS) & 2011/65/EU (RoHS 2) compliant. All applicable RoHS exemptions applied.
 2. See http://www.diodes.com/quality/lead_free.html for more information about Diodes Incorporated's definitions of Halogen- and Antimony-free, "Green" and Lead-free.
 3. Halogen- and Antimony-free "Green" products are defined as those which contain <900ppm bromine, <900ppm chlorine (<1500ppm total Br + Cl) and <1000ppm antimony compounds.
 4. For packaging details, go to our website at <http://www.diodes.com/products/packages.html>.

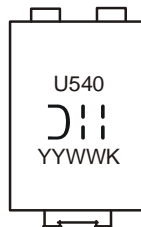
Marking Information

U540 = Product Type Marking Code
 ⌐||| = Manufacturer's Code Marking
 YYWW = Date Code Marking
 YY = Last Two Digits of Year (ex: 06 = 2006)
 WW = Week Code (01 to 52)
 K = Factory Designator

Maximum Ratings (@ $T_A = +25^\circ\text{C}$, unless otherwise specified.)

Single phase, half wave, 60Hz, resistive or inductive load.
For capacitive load, derate current by 20%.

Characteristic	Symbol	Value	Unit
Peak Repetitive Reverse Voltage Working Peak Reverse Voltage DC Blocking Voltage	V_{RRM} V_{RWM} V_R	400	V
RMS Reverse Voltage	$V_{R(RMS)}$	283	V
Average Rectified Output Current (See Figure 4)	I_O	5	A
Non-Repetitive Peak Forward Surge Current 8.3ms Single Half Sine-Wave Superimposed on Rated Load	I_{FSM}	125	A

Thermal Characteristics

Characteristic	Symbol	Typ	Max	Unit
Thermal Resistance Junction to Soldering Point	$R_{\theta JS}$	—	3.0	$^\circ\text{C/W}$
Thermal Resistance Junction to Ambient Air (Note 5)	$T_A = +25^\circ\text{C}$ $R_{\theta JA}$	95	—	$^\circ\text{C/W}$
Thermal Resistance Junction to Ambient Air (Note 6)	$T_A = +25^\circ\text{C}$ $R_{\theta JA}$	55	—	$^\circ\text{C/W}$
Thermal Resistance Junction to Ambient Air (Note 7)	$T_A = +25^\circ\text{C}$ $R_{\theta JA}$	40	—	$^\circ\text{C/W}$
Operating Temperature Range	T_J	-65 to +150		$^\circ\text{C}$
Storage Temperature Range	T_{STG}	-65 to +150		$^\circ\text{C}$

Electrical Characteristics (@ $T_A = +25^\circ\text{C}$, unless otherwise specified.)

Characteristic	Symbol	Value	Unit	Test Condition
Minimum Reverse Breakdown Voltage (Note 8)	$V_{(BR)R}$	400	V	$I_R = 10\mu\text{A}$
Maximum Forward Voltage	V_{FM}	1.185 0.935 1.25 1.00	V	$I_F = 5\text{A}, T_S = +25^\circ\text{C}$ $I_F = 5\text{A}, T_S = +150^\circ\text{C}$ $I_F = 8\text{A}, T_S = +25^\circ\text{C}$ $I_F = 8\text{A}, T_S = +150^\circ\text{C}$
Maximum Reverse Leakage Current (Note 8)	I_{RM}	10 500	μA	$T_S = +25^\circ\text{C}, V_R = 400\text{V}$ $T_S = +100^\circ\text{C}, V_R = 400\text{V}$
Maximum Reverse Recovery Time	t_{RR}	35	ns	$I_F = 0.5\text{A}, I_R = 1.0\text{A}$ $I_{RR} = 0.25\text{A}$ (See Figure 7)

- Notes:
- FR-4 PCB, 2 oz. Copper, minimum recommended pad layout per <http://www.diodes.com/package-outlines.html>.
 - Polymide PCB, 2oz. Copper, minimum recommended pad layout per <http://www.diodes.com/package-outlines.html>.
 - Polymide PCB, 2oz. Copper. Cathode pad dimensions 9.4mm x 7.2mm. Anode pad dimensions 2.7mm x 1.6mm.
 - Short duration pulse test used to minimize self-heating effect.

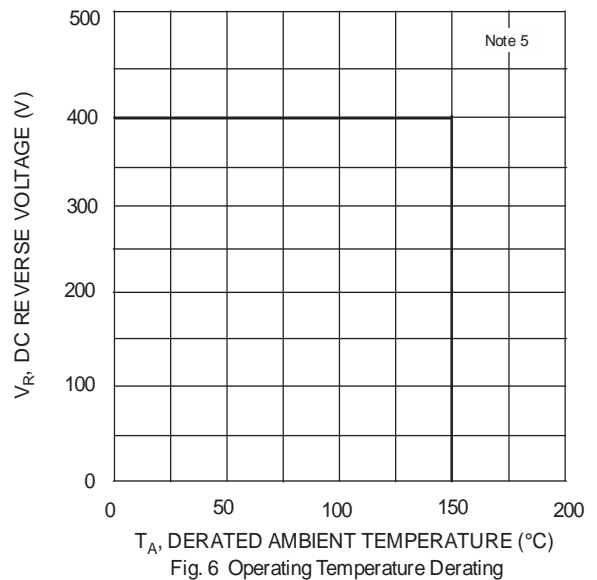
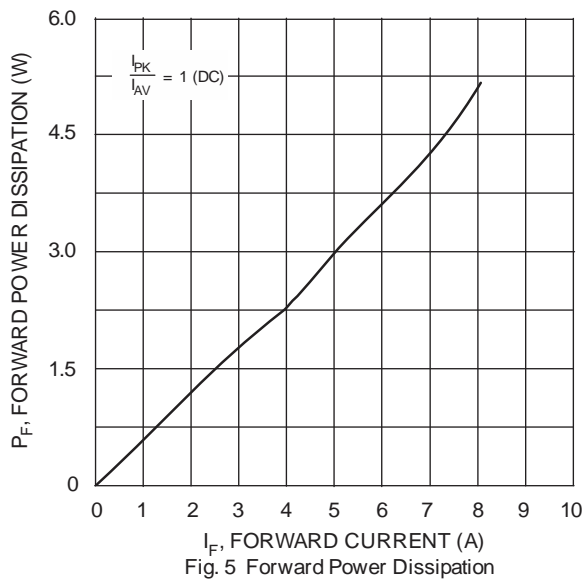
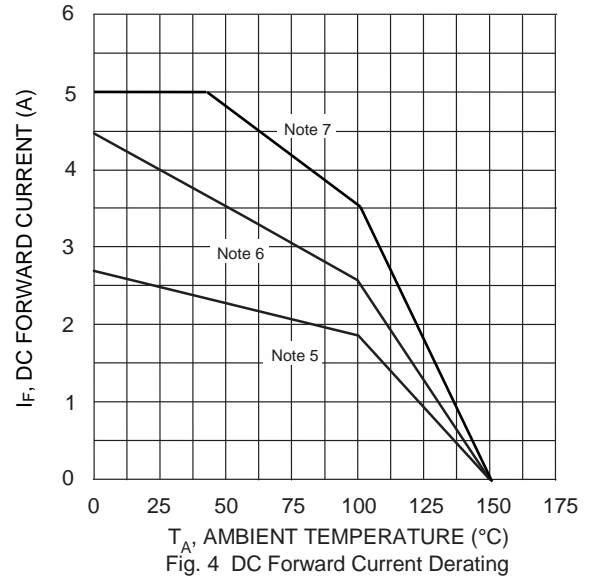
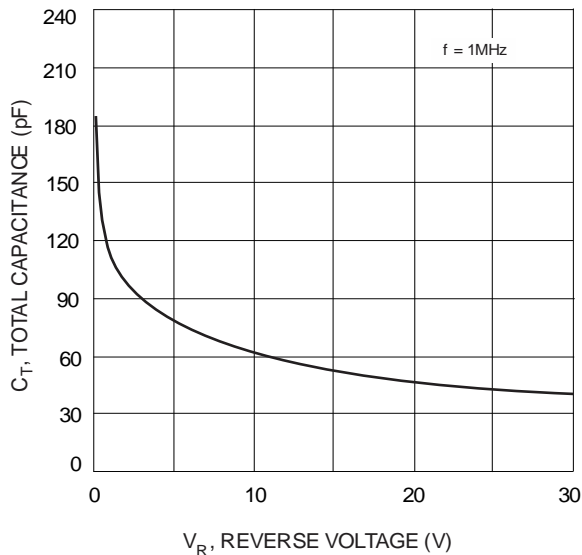
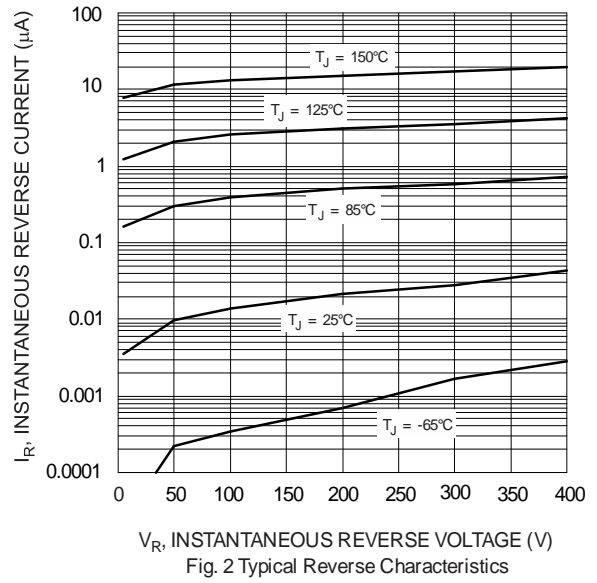
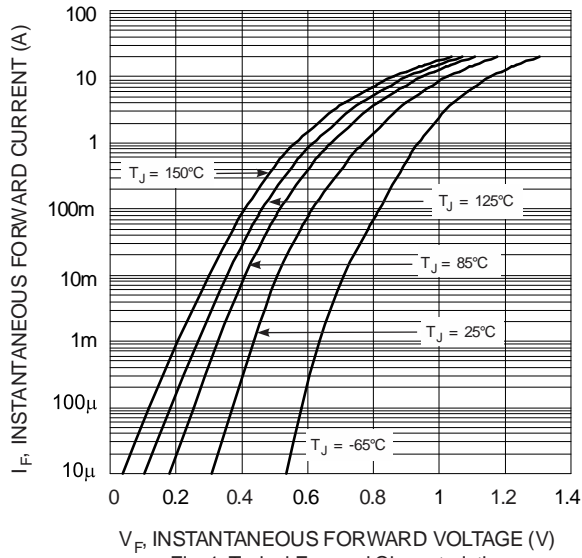

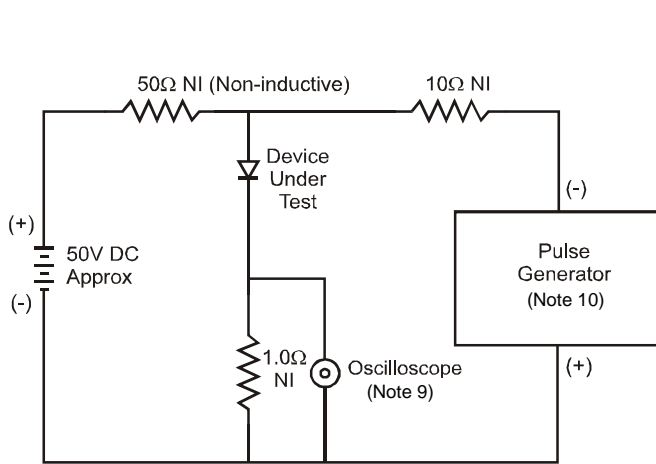

Notes:
 9. Rise Time = 7.0ns max. Input Impedance = 1.0MΩ, 22pF.
 10. Rise Time = 10ns max. Input Impedance = 50Ω.

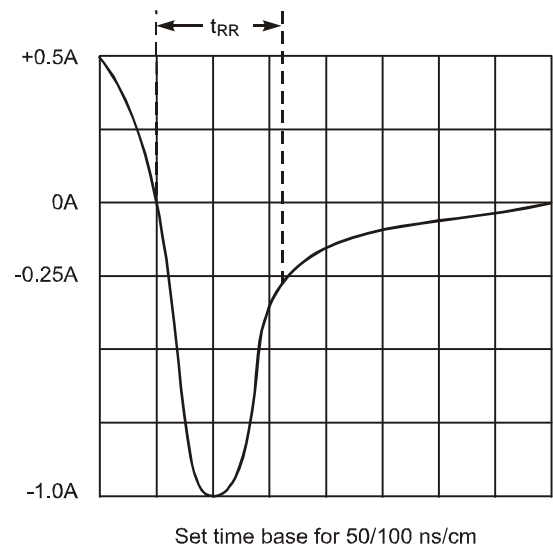
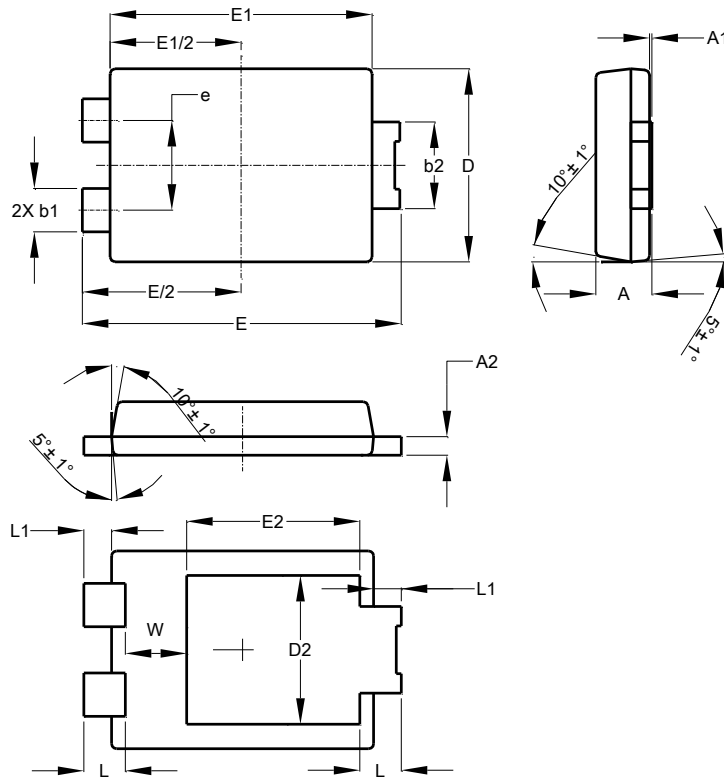

Fig. 7 Reverse Recovery Time Characteristic and Test Circuit

Package Outline Dimensions

Please see <http://www.diodes.com/package-outlines.html> for the latest version.

PowerDI5



PowerDI5			
Dim	Min	Max	Typ
A	1.05	1.15	1.10
A1	0.00	0.05	—
A2	0.33	0.43	0.381
b1	0.80	0.99	0.89
b2	1.70	1.88	1.78
D	3.90	4.05	3.966
D2	—	—	3.054
E	6.40	6.60	6.504
e	—	—	1.84
E1	5.30	5.45	5.37
E2	—	—	3.549
L	0.75	0.95	0.85
L1	0.50	0.65	0.57
W	1.10	1.41	1.255

All Dimensions in mm

Suggested Pad Layout

Please see <http://www.diodes.com/package-outlines.html> for the latest version.

PowerDI5

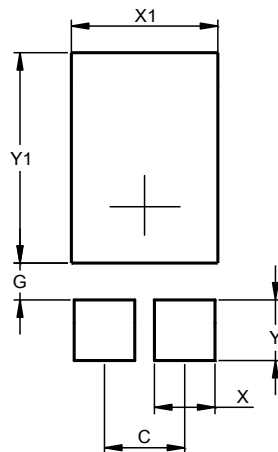

Dimensions	Value (in mm)
C	1.840
G	0.852
X	1.390
X1	3.360
Y	1.400
Y1	4.860

IMPORTANT NOTICE

DIODES INCORPORATED MAKES NO WARRANTY OF ANY KIND, EXPRESS OR IMPLIED, WITH REGARDS TO THIS DOCUMENT, INCLUDING, BUT NOT LIMITED TO, THE IMPLIED WARRANTIES OF MERCHANTABILITY AND FITNESS FOR A PARTICULAR PURPOSE (AND THEIR EQUIVALENTS UNDER THE LAWS OF ANY JURISDICTION).

Diodes Incorporated and its subsidiaries reserve the right to make modifications, enhancements, improvements, corrections or other changes without further notice to this document and any product described herein. Diodes Incorporated does not assume any liability arising out of the application or use of this document or any product described herein; neither does Diodes Incorporated convey any license under its patent or trademark rights, nor the rights of others. Any Customer or user of this document or products described herein in such applications shall assume all risks of such use and will agree to hold Diodes Incorporated and all the companies whose products are represented on Diodes Incorporated website, harmless against all damages.

Diodes Incorporated does not warrant or accept any liability whatsoever in respect of any products purchased through unauthorized sales channel. Should Customers purchase or use Diodes Incorporated products for any unintended or unauthorized application, Customers shall indemnify and hold Diodes Incorporated and its representatives harmless against all claims, damages, expenses, and attorney fees arising out of, directly or indirectly, any claim of personal injury or death associated with such unintended or unauthorized application.

Products described herein may be covered by one or more United States, international or foreign patents pending. Product names and markings noted herein may also be covered by one or more United States, international or foreign trademarks.

This document is written in English but may be translated into multiple languages for reference. Only the English version of this document is the final and determinative format released by Diodes Incorporated.

LIFE SUPPORT

Diodes Incorporated products are specifically not authorized for use as critical components in life support devices or systems without the express written approval of the Chief Executive Officer of Diodes Incorporated. As used herein:

A. Life support devices or systems are devices or systems which:

1. are intended to implant into the body, or
2. support or sustain life and whose failure to perform when properly used in accordance with instructions for use provided in the labeling can be reasonably expected to result in significant injury to the user.

B. A critical component is any component in a life support device or system whose failure to perform can be reasonably expected to cause the failure of the life support device or to affect its safety or effectiveness.

Customers represent that they have all necessary expertise in the safety and regulatory ramifications of their life support devices or systems, and acknowledge and agree that they are solely responsible for all legal, regulatory and safety-related requirements concerning their products and any use of Diodes Incorporated products in such safety-critical, life support devices or systems, notwithstanding any devices- or systems-related information or support that may be provided by Diodes Incorporated. Further, Customers must fully indemnify Diodes Incorporated and its representatives against any damages arising out of the use of Diodes Incorporated products in such safety-critical, life support devices or systems.

Copyright © 2016, Diodes Incorporated

www.diodes.com

单击下面可查看定价，库存，交付和生命周期等信息

[>>Diodes Incorporated\(达尔科技\)](#)