

Features

- Glass Passivated Die Construction
- Super-Fast Recovery Time For High Efficiency
- Low Forward Voltage Drop and High Current Capability
- Surge Overload Rating to 35A Peak
- **Lead Free Finish, RoHS Compliant (Note 3)**

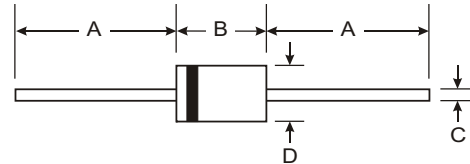

Mechanical Data

- Case: DO-41
- Case Material: Molded Plastic. UL Flammability Classification Rating 94V-0
- Moisture Sensitivity: Level 1 per J-STD-020C
- Terminals: Finish - Bright Tin. Solderable per MIL-STD-202, Method 208
- Polarity: Cathode Band
- Ordering Information: See Last Page
- Marking: R120
- Weight: 0.34 grams (approximate)

| DO-41 Plastic | | |
|----------------------|-------|-------|
| Dim | Min | Max |
| A | 25.40 | — |
| B | 4.06 | 5.21 |
| C | 0.71 | 0.864 |
| D | 2.00 | 2.72 |
| All Dimensions in mm | | |

Maximum Ratings and Electrical Characteristics

@ T_A = 25°C unless otherwise specified

Single phase, half wave, 60Hz, resistive or inductive load.
For capacitive load, derate current by 20%.

| Characteristic | Symbol | Value | Unit |
|---|--|----------------|------|
| Peak Repetitive Reverse Voltage Working Peak Reverse Voltage DC Blocking Voltage | V _{RRM} V _{RWM} V _R | 200 | V |
| RMS Reverse Voltage | V _{R(RMS)} | 140 | V |
| Average Rectified Output Current @ T _L = 130°C | I _O | 1.0 | A |
| Non-Repetitive Peak Forward Surge Current 8.3ms Single half sine-wave Superimposed on Rated Load (JEDEC Method) | I _{FSM} | 35 | A |
| Forward Voltage @ I _F = 1.0A, T _J = 25°C @ I _F = 1.0A, T _J = 150°C | V _{FM} | 0.875 0.710 | V |
| Peak Reverse Current at Rated DC Blocking Voltage @ T _J = 25°C @ T _J = 150°C | I _{RM} | 2.0 50 | μA |
| Reverse Recovery Time (Note 2) | t _{rr} | 25 | ns |
| Typical Junction Capacitance (Note 1) | C _j | 27 | pF |
| Typical Thermal Resistance, Junction to Lead | R _{θJL} | 50 | K/W |
| Operating and Storage Temperature Range | T _j , T _{STG} | -55 to +150 | °C |

- Notes:
1. Measured at 1.0MHz and applied reverse voltage of 4V DC.
 2. Measured with I_F = 0.5A, I_R = 1.0A, I_{rr} = 0.25A. See Figure 6.
 3. RoHS revision 13.2.2003. Glass and High Temperature Solder Exemptions Applied, see *EU Directive Annex Notes 5 and 7*.

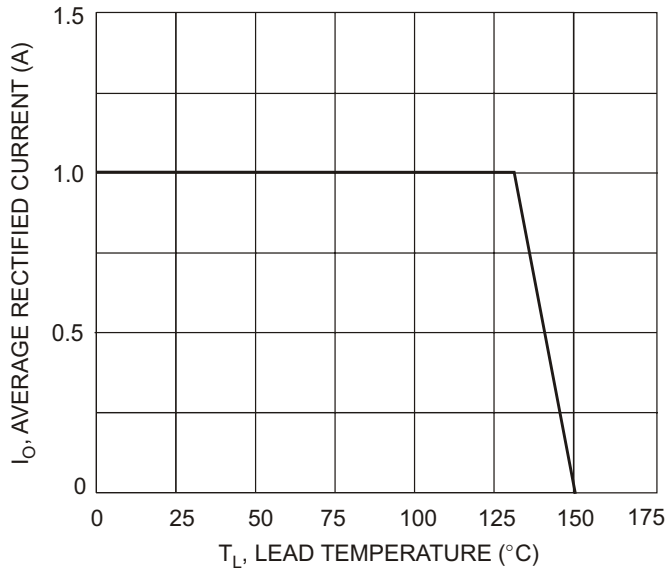

Fig. 1 Forward Current Derating Curve

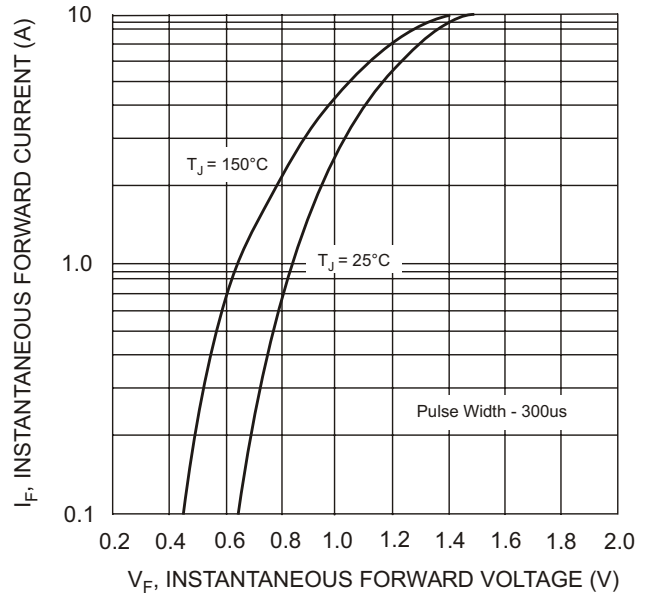

Fig. 2 Typical Forward Characteristics

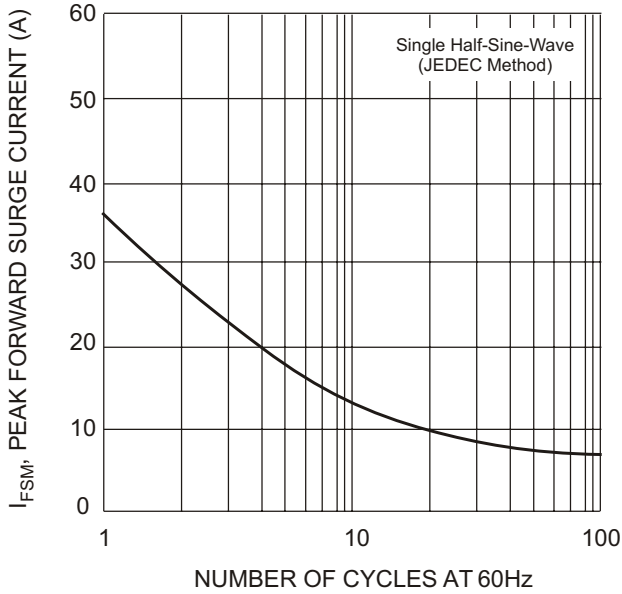

Fig. 3 Surge Current Derating Curve

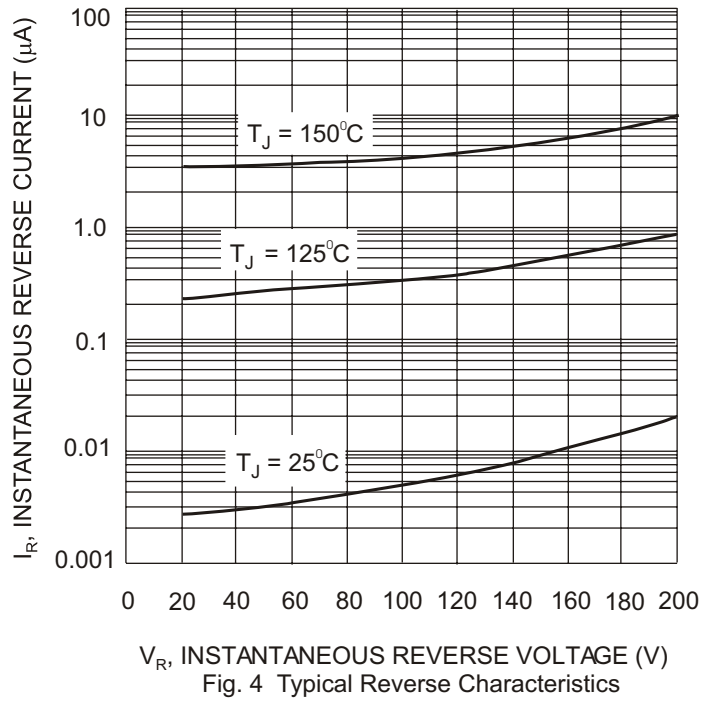

Fig. 4 Typical Reverse Characteristics

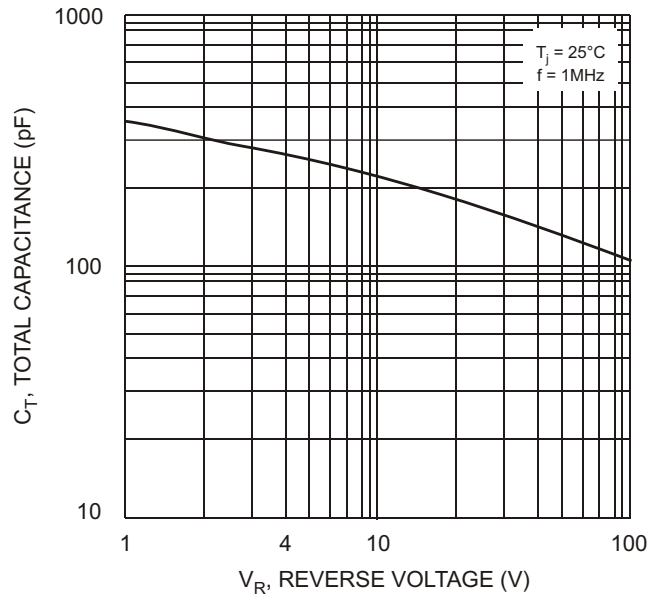

Fig. 5 Typical Total Capacitance

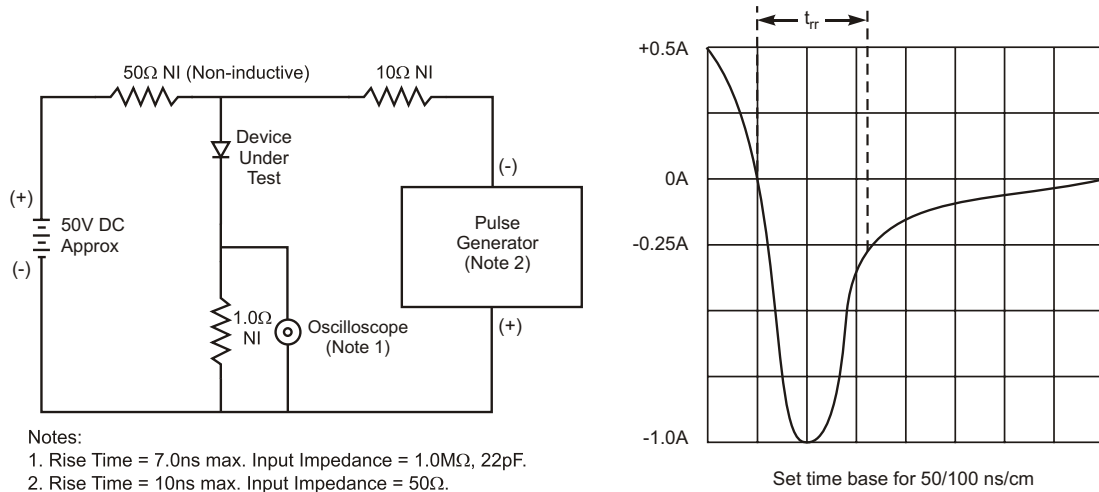

Fig. 6 Reverse Recovery Time Characteristic and Test Circuit

Ordering Information (Note 4)

| Device | Packaging | Shipping |
|----------|-----------|-------------------------|
| MUR120-A | DO-41 | 5K/Ammo Pack |
| MUR120-B | DO-41 | 1K/Bulk |
| MUR120-T | DO-41 | 5K/Tape & Reel, 13-inch |

Notes: 4. For packaging details, visit our website at <http://www.diodes.com/datasheets/ap02008.pdf>

单击下面可查看定价，库存，交付和生命周期等信息

[>>Diodes Incorporated\(达达科技\(美台\)\)](#)