

**GENERAL PURPOSE, LOW VOLTAGE,
RAIL-TO-RAIL OUTPUT OPERATIONAL AMPLIFIERS**

Description

The LMV321/LMV358/LMV324 are low voltage (2.7V to 5.5V) single, dual and quad operational amplifiers. The LMV321/LMV358/LMV324 are designed to effectively reduce cost and space at low voltage levels.

These devices have the capability of rail-to-rail output swing and input common-mode voltage range includes ground. They can also achieve an efficient speed-to-power ratio, utilizing 1 MHz bandwidth and 1V/ μ s slew rate at a low supply current. Reducing noise pickup and increasing signal integrity can be achieved by placing the device close to the signal source.

The LMV321 is available in 5-Pin SOT353/SOT25 packages that reduce space on PC boards and portable electronic devices. The LMV324 is available in the SO-14 and TSSOP-14 package.

The LMV358 is available in the MSOP-8 and SO-8 packages.

Features

(For V^+ = 5V and V^- = 0V typical unless otherwise noted)

- Guaranteed 2.7V and 5V Performance
- Crossover Distortion Eliminated
- Operating Temperature Range (-40°C to +125°C)
- Gain-bandwidth Product 1 MHz
- Low Supply Current
 - LMV321 110 μ A Typ
 - LMV358 190 μ A Typ
 - LMV324 340 μ A Typ
- Rail-to-Rail Output Swing @ 10k Ω
 - V^+ -10 mV
 - V^- +10 mV
- Input Common Mode Voltage Range (-0.2 to V^+ -0.8V)
- Manufactured in Standard CMOS Process
- SOT353, SOT25, MSOP-8, SO-8, SO-14 & TSSOP-14:
Available in "Green" Molding Compound (No Br, Sb)
- **Totally Lead-Free & Fully RoHS Compliant (Notes 1 & 2)**
- **Halogen and Antimony Free. "Green" Device (Note 3)**

Notes: 1. No purposely added lead. Fully EU Directive 2002/95/EC (RoHS) & 2011/65/EU (RoHS 2) compliant.
2. See <http://www.diodes.com> for more information about Diodes Incorporated's definitions of Halogen- and Antimony-free, "Green" and Lead-free.
3. Halogen- and Antimony-free "Green" products are defined as those which contain <900ppm bromine, <900ppm chlorine (<1500ppm total Br + Cl) and <1000ppm antimony compounds.

Pin Assignments

(Top View)

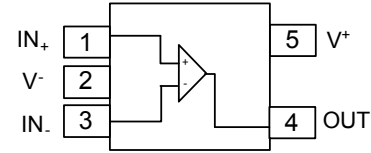

SOT25 / SOT353

(Top View)

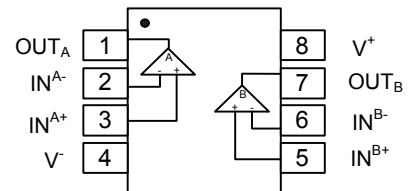

SO-8 / MSOP-8

(Top View)

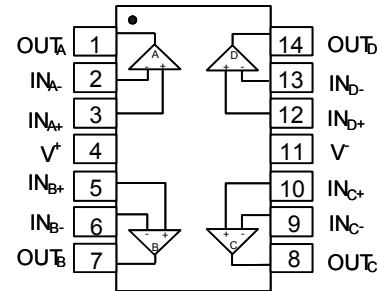

SOP-14L / TSSOP-14L

Applications

- Active Filters
- General Purpose Low Voltage Applications
- General Purpose Portable Devices

Absolute Maximum Ratings (Note 4) (@T_A = +25°C, unless otherwise specified.)

Symbol	Parameter	Rating	Unit	
ESD HBM	Human Body Model ESD Protection	LMV321	4.0	KV
		LMV358	4.0	
		LMV324	4.5	
ESD MM	Machine Model ESD Protection	LMV321	350	V
		LMV358	350	
		LMV324	250	
	Differential Input Voltage	±Supply Voltage	V	
V ⁺ -V ⁻	Supply Voltage	5.5	V	
	Output Short Circuit to V ⁺	(Note 5)		
	Output Short Circuit to V ⁻	(Note 6)		
T _{ST}	Storage Temperature	-65 to +150	°C	
T _J	Maximum Junction Temperature	+150	°C	

- Notes:
4. Absolute Maximum Ratings indicate limits beyond which damage to the device may occur. Operating Ratings indicate conditions for which the device is intended to be functional, but specific performance is not guaranteed. For guaranteed specifications and the test conditions, see the Electrical Characteristics.
 5. Shorting output to V⁺ will adversely affect reliability.
 6. Shorting output to V⁻ will adversely affect reliability.

Recommended Operating Conditions (@T_A = +25°C, unless otherwise specified.)

Symbol	Parameter	Rating	Unit
V ⁺ -V ⁻	Supply Voltage	2.7 to 5.5	V
T _A	Operating Ambient Temperature Range	-40 to +125	°C

Electrical Characteristics (@T_A = +25°C, unless otherwise specified.)

2.7V DC Electrical Characteristics

Unless otherwise specified, all limits guaranteed for T_A = +25°C, V⁺ = 2.7V, V⁻ = 0V, V_{CM} = 1.0V, V_O = V⁺/2 and R_L > 1 MΩ.

Symbol	Parameter	Test Conditions	Min (Note 8)	Typ (Note 7)	Max (Note 8)	Unit
V _{OS}	Input Offset Voltage			1.7	7	mV
TCV _{OS}	Input Offset Voltage Average Drift			5		μV/°C
I _B	Input Bias Current			10		nA
I _{OS}	Input Offset Current			5	50	nA
CMRR	Common Mode Rejection Ratio	0V ≤ V _{CM} ≤ 1.7V	50	63		dB
PSRR	Power Supply Rejection Ratio	2.7V ≤ V ⁺ ≤ 5V, V _O = 1V	50	60		dB
V _{CMR}	Input Common-Mode Voltage Range	For CMRR ≥ 50dB	0	-0.2		V
				1.9	1.7	
V _O	Output Swing	R _L = 10 kΩ to 1.35V	V ⁺ - 100	V ⁺ - 20		mV
				20	100	
I _S	Supply Current	LMV321 Single amplifier		110	140	μA
		LMV358 Both amplifiers		190	340	μA
		LMV324 All four amplifiers		340	680	μA

2.7V AC Electrical Characteristics

Unless otherwise specified, all limits guaranteed for T_A = +25°C, V⁺ = 2.7V, V⁻ = 0V, V_{CM} = 1.0V, V_O = V⁺/2 and R_L > 1 MΩ.

Symbol	Parameter	Test Conditions	Min	Typ	Max	Unit
GBWP	Gain-Bandwidth Product	C _L = 200 pF		1		MHz
Φ _m	Phase Margin			60		Deg
G _m	Gain Margin			10		dB
e _n	Input-Referred Voltage Noise	f > 50 kHz		23		$\frac{nV}{\sqrt{Hz}}$

Electrical Characteristics (cont.) (@ $T_A = +25^\circ\text{C}$, unless otherwise specified.)

5V DC Electrical Characteristics

 Unless otherwise specified, all limits guaranteed for $T_A = +25^\circ\text{C}$, $V^+ = 5\text{V}$, $V^- = 0\text{V}$, $V_{\text{CM}} = 2.0\text{V}$, $V_O = V^+/2$ and $R_L > 1\text{M}\Omega$.

Symbol	Parameter	Test Conditions	Min (Note 8)	Typ (Note 7)	Max (Note 8)	Unit		
V_{OS}	Input Offset Voltage	$T_A = +25^\circ\text{C}$		1.7	7	mV		
		$T_A = \text{full range}$			9			
TCV_{OS}	Input Offset Voltage Average Drift			5		$\mu\text{V}/^\circ\text{C}$		
I_B	Input Bias Current	$T_A = +25^\circ\text{C}$		15	250	nA		
		$T_A = \text{full range}$			500			
I_{OS}	Input Offset Current	$T_A = +25^\circ\text{C}$		5	50	nA		
		$T_A = \text{full range}$			150			
CMRR	Common Mode Rejection Ratio	$0\text{V} \leq V_{\text{CM}} \leq 4.0\text{V}$	50	65		dB		
PSRR	Power Supply Rejection Ratio	$2.7\text{V} \leq V^+ \leq 5\text{V}$ $V_O = 1\text{V}$, $V_{\text{CM}} = 1\text{V}$	50	60		dB		
V_{CMR}	Input Common-Mode Voltage Range	For CMRR $\geq 50\text{dB}$	0	-0.2		V		
				4.2	4.0			
A_V	Large Signal Voltage Gain	$R_L = 2\text{ k}\Omega$ (Note 9)	$T_A = +25^\circ\text{C}$	15	100	V/mV		
			$T_A = \text{full range}$	10				
V_O	Output Swing	$R_L = 2\text{ k}\Omega$ to 2.5V	High level	$T_A = +25^\circ\text{C}$	$V^+ - 300$	$V^+ - 50$	mV	
				$T_A = \text{full range}$	$V^+ - 400$			
			Low level	$T_A = +25^\circ\text{C}$		50		300
				$T_A = \text{full range}$				400
		$R_L = 10\text{ k}\Omega$ to 2.5V	High level	$T_A = +25^\circ\text{C}$	$V^+ - 100$	$V^+ - 10$		
				$T_A = \text{full range}$	$V^+ - 200$			
Low level	$T_A = +25^\circ\text{C}$		10	180				
	$T_A = \text{full range}$			280				
I_O	Output Short Circuit Current	Sourcing, $V_O = 0\text{V}$	5	60		mA		
		Sinking, $V_O = 5\text{V}$	10	90				
I_S	Supply Current	LMV321 Single amplifier		110	140	μA		
		LMV358 Both amplifiers	$T_A = +25^\circ\text{C}$	190	340			
			$T_A = \text{full range}$		600			
		LMV324 All four amplifiers	$T_A = +25^\circ\text{C}$	340	680			
$T_A = \text{full range}$			1100					
θ_{JA}	Thermal Resistance Junction-to-Ambient	SOT353 (Note 10)		330		$^\circ\text{C}/\text{W}$		
		SOT25 (Note 10)		250				
		TSSOP-14 (Note 10)		100				
		MSOP-8 (Note 10)		203				
		SO-8 (Note 10)		150				
		SO-14 (Note 10)		83				

5V AC Electrical Characteristics

 Unless otherwise specified, all limits guaranteed for $T_A = 25^\circ\text{C}$, $V^+ = 5\text{V}$, $V^- = 0\text{V}$, $V_{\text{CM}} = 2.0\text{V}$, $V_O = V^+/2$ and $R_L > 1\text{M}\Omega$.

Boldface limits apply at the temperature extremes.

SR	Slew Rate	(Note 11)		1		V/ μs
GBWP	Gain-Bandwidth Product	$C_L = 200\text{pF}$		1		MHz
Φ_m	Phase Margin			60		Deg
G_m	Gain Margin			10		dB
e_n	Input-Referred Voltage Noise	$f > 50\text{ kHz}$		23		$\frac{\text{nV}}{\sqrt{\text{Hz}}}$

- Notes:
- Typical values represent the most likely parametric norm as determined at the time of characterization. Actual typical values may vary over time and will also depend on the application and configuration. The typical values are not tested and are not guaranteed on shipped production material.
 - All limits are guaranteed by testing or statistical analysis.
 - R_L is connected to V^- . The output voltage is $0.5\text{V} \leq V_O \leq 4.5\text{V}$.
 - All numbers are typical, and apply for packages soldered directly onto a PC board in still air.
 - Connected as voltage follower with 3V step input. Number specified is the slower of the positive and negative slew rates.

Typical Performance Characteristics ($V_S = +5V$, single supply, @ $T_A = +25^\circ C$, unless otherwise specified.)

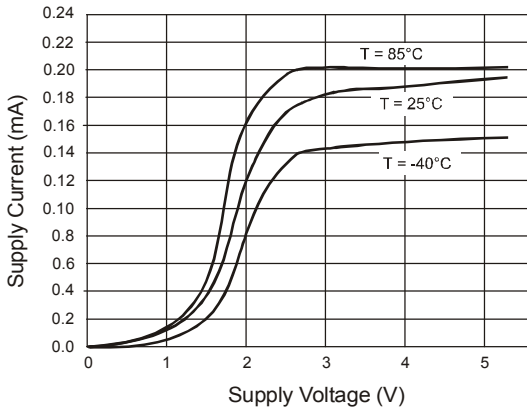

Supply Current vs. Supply Voltage

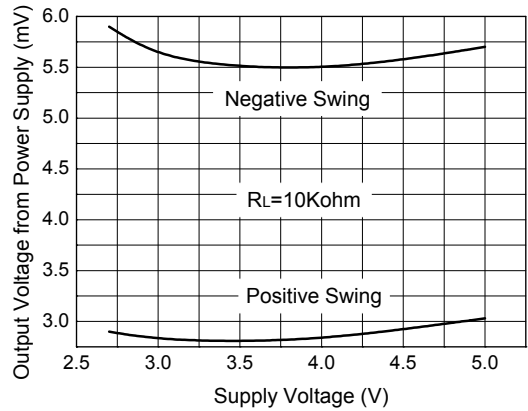

Output Voltage Swing vs. Supply Voltage

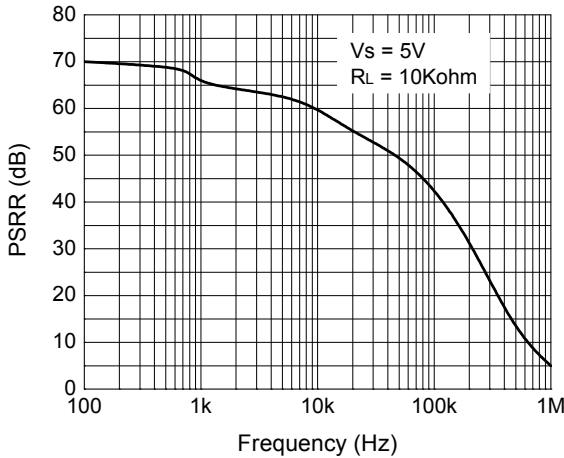

PSRR vs. Frequency

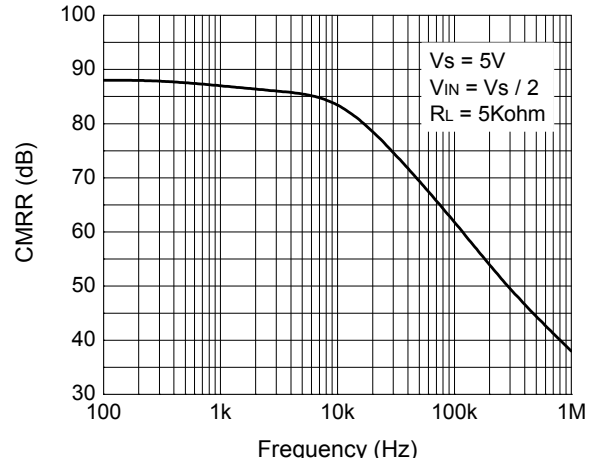

CMRR vs. Frequency

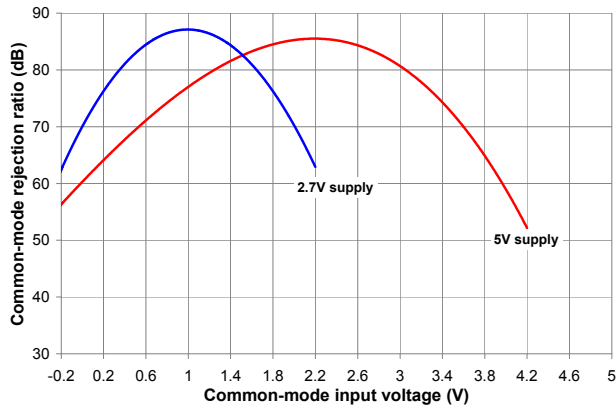

CMRR vs. Input Common Mode Voltage

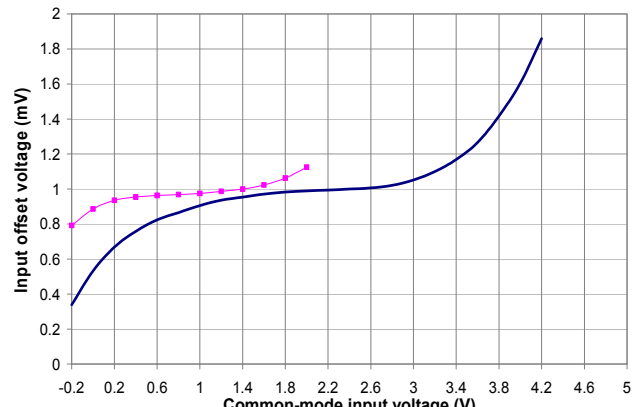

ΔV_{os} vs. CMR

Typical Performance Characteristics (cont.)

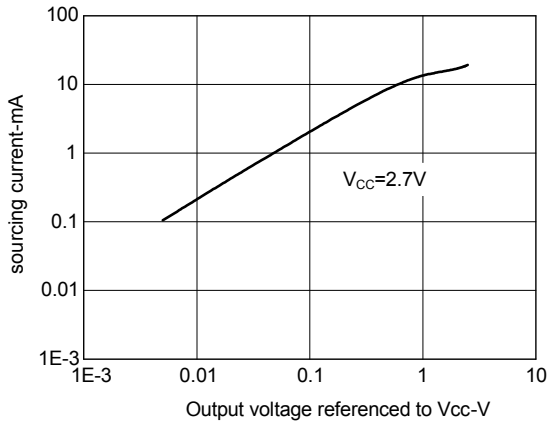

Sourcing Current vs. Output Voltage (2.7V)

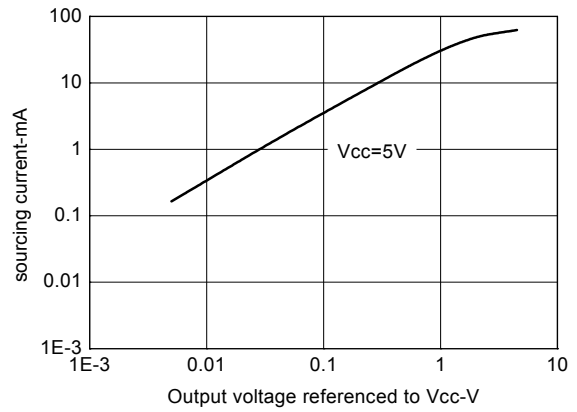

Sourcing Current vs. Output Voltage (5V)

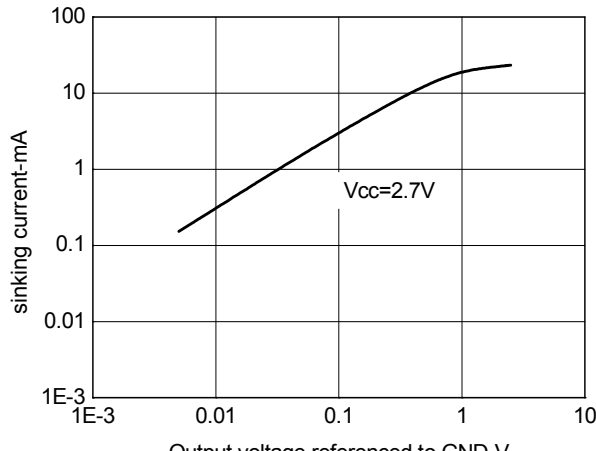

Sinking Current vs. Output Voltage (2.7V)

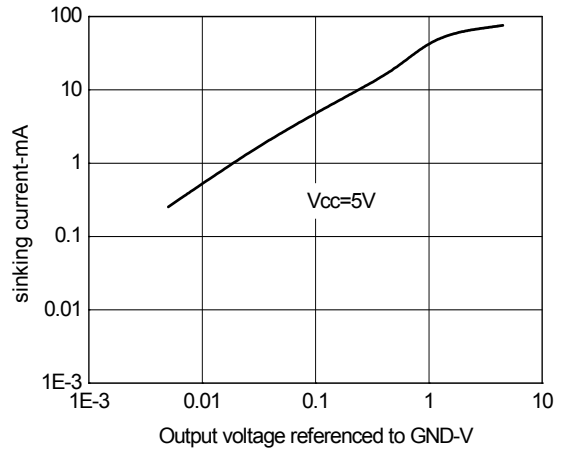

Sinking Current vs. Output Voltage (5V)

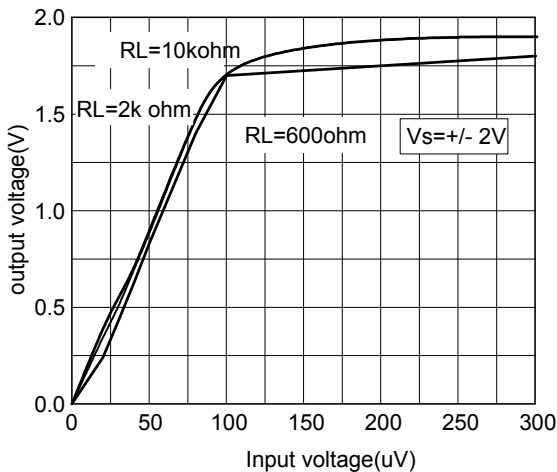

Input Voltage vs. Output Voltage

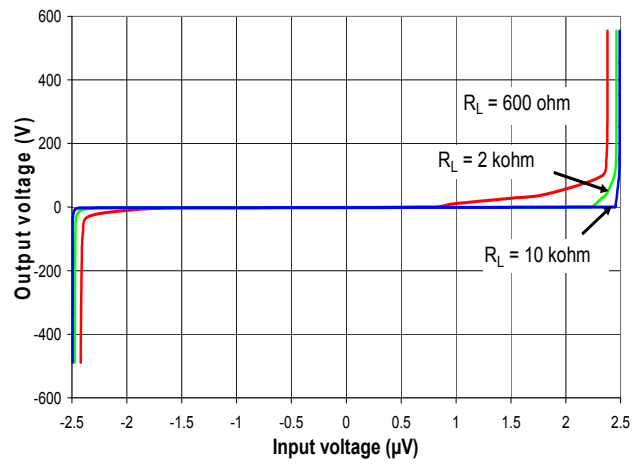

Output Voltage vs. Input Voltage

Typical Performance Characteristics (cont.)

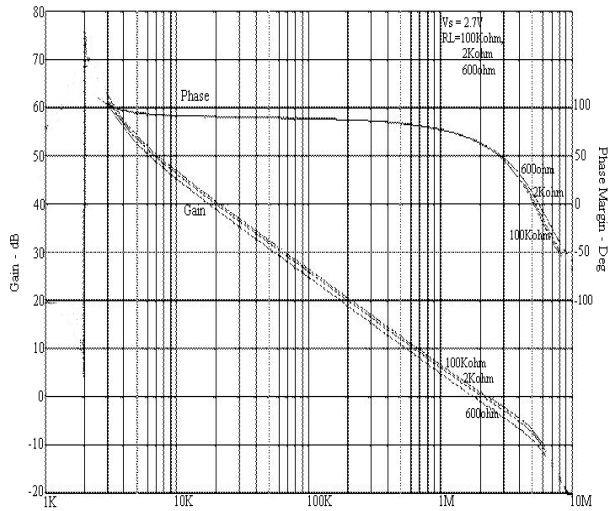

Frequency Response vs. Resistive Load (2.7V)

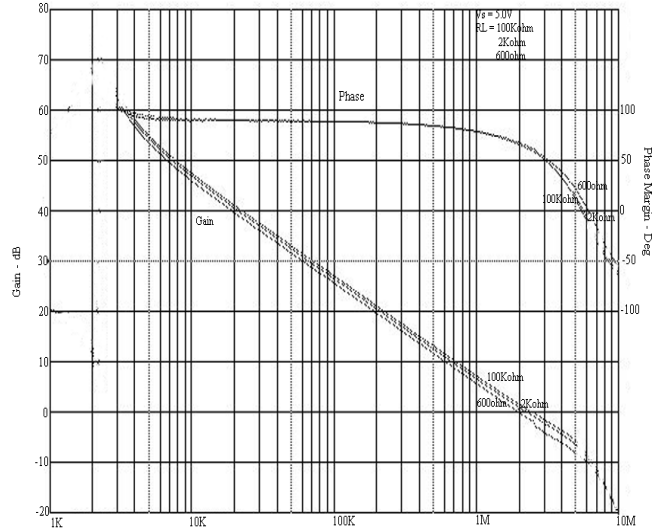

Frequency Response vs. Resistive Load (5V)

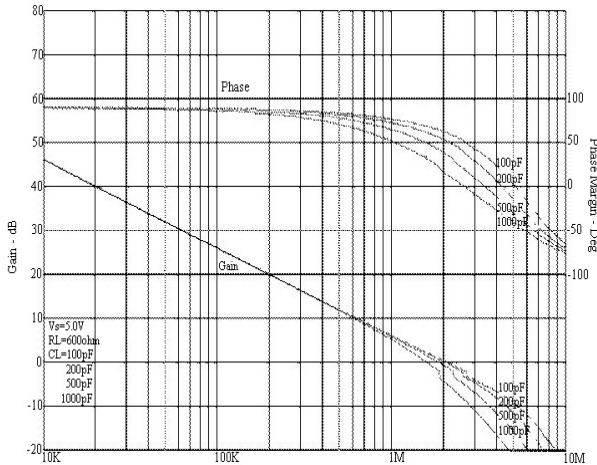

Frequency Response vs. Capacitive Load (2.7V)

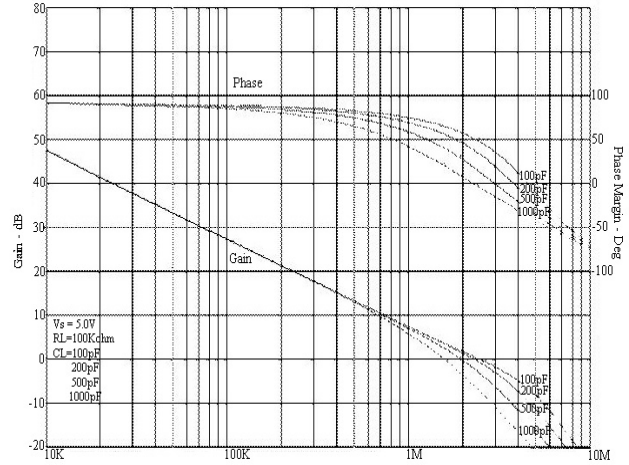

Frequency Response vs. Capacitive Load (5V)

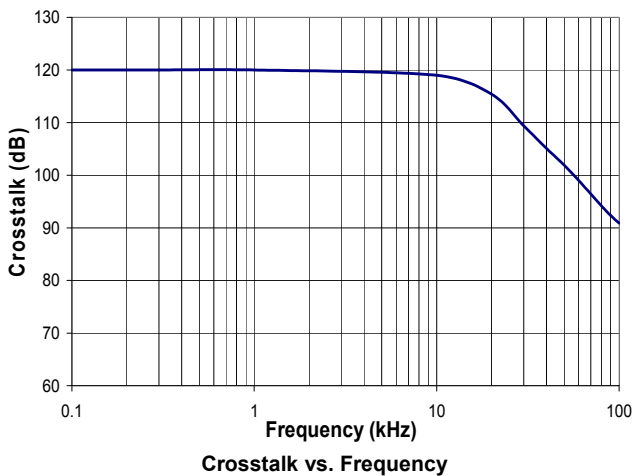

Crosstalk vs. Frequency

Typical Performance Characteristics (cont.)

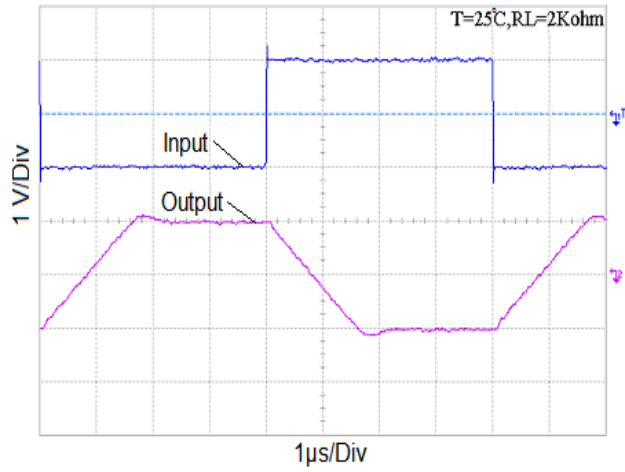

Inverting Large Signal Pulse Response

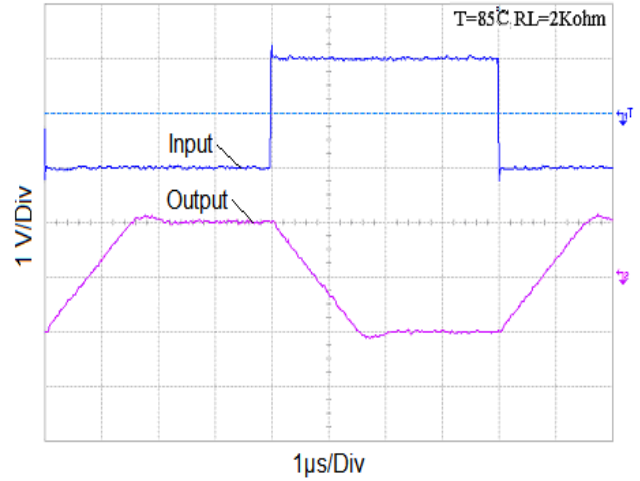

Inverting Large Signal Pulse Response

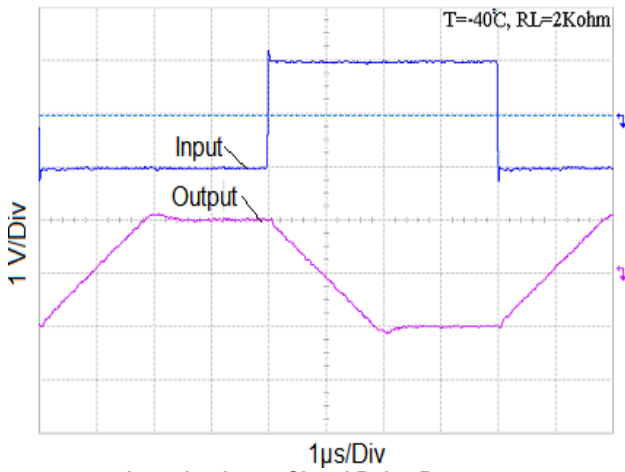

Inverting Large Signal Pulse Response

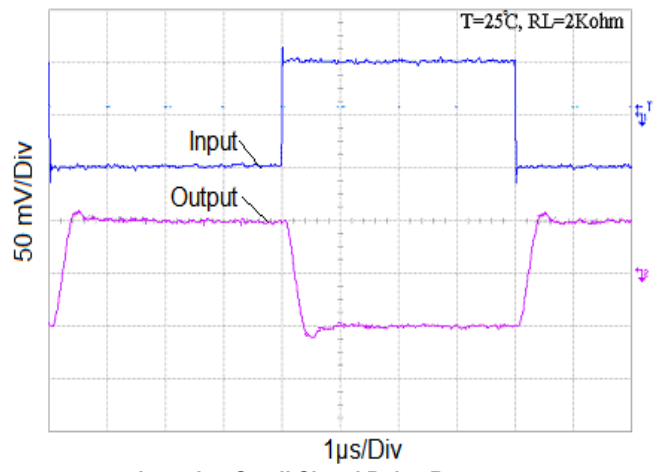

Inverting Small Signal Pulse Response

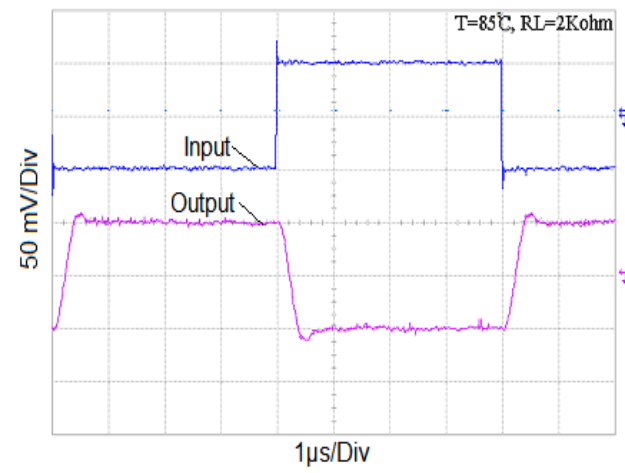

Inverting Small Signal Pulse Response

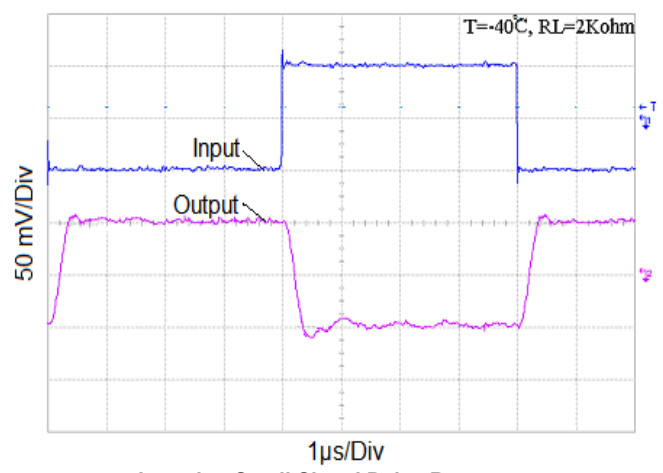

Inverting Small Signal Pulse Response

Typical Performance Characteristics (cont.)

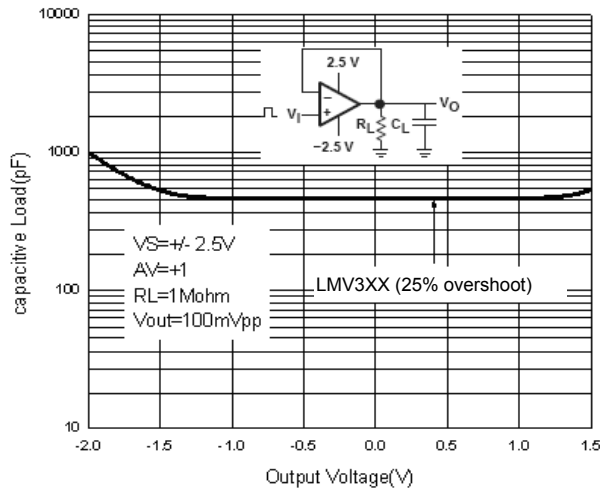

Stability vs. Capacitive Load

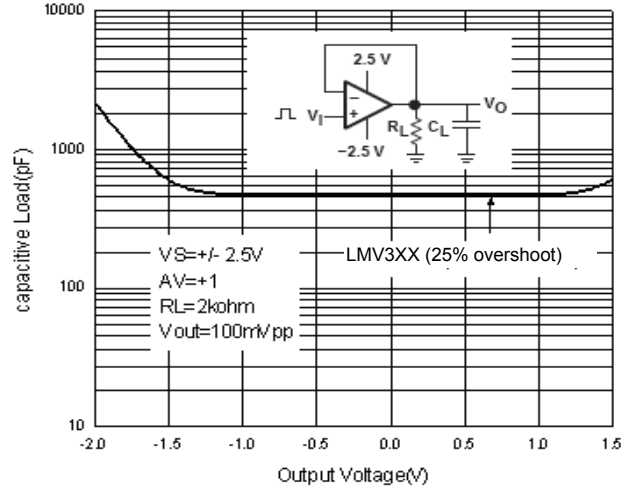

Stability vs. Capacitive Load

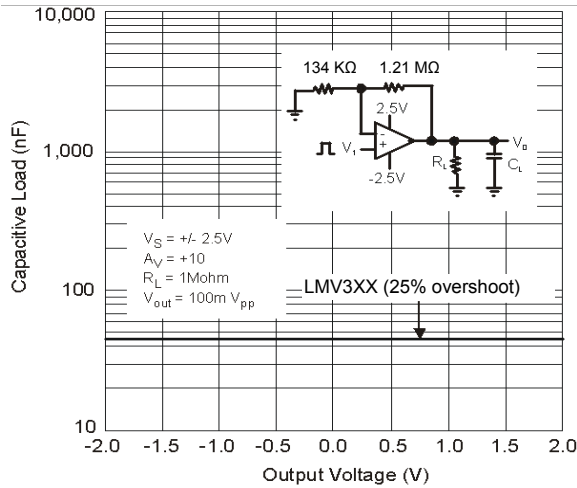

Stability vs. Capacitive Load

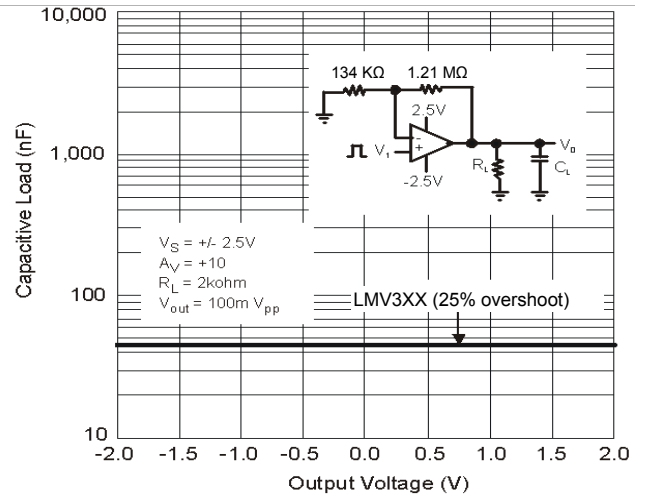

Stability vs. Capacitive Load

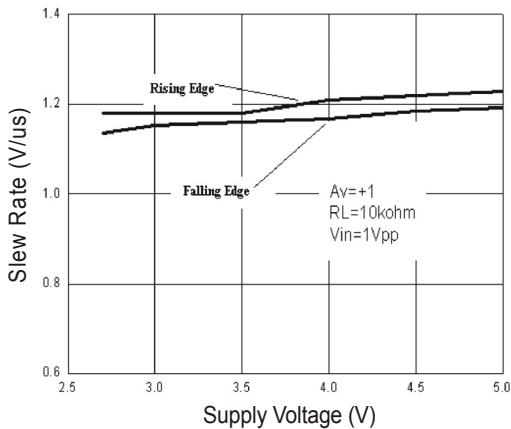

Slew Rate vs. Supply Voltage

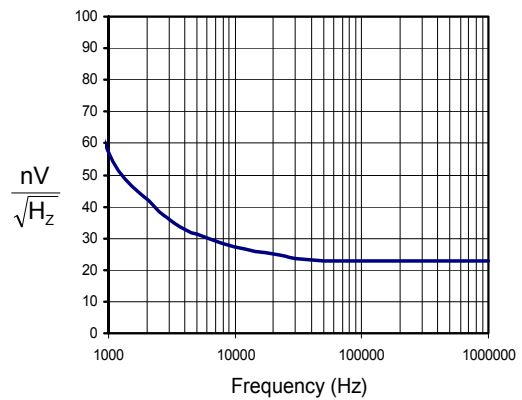

Input Voltage Noise

Ordering Information

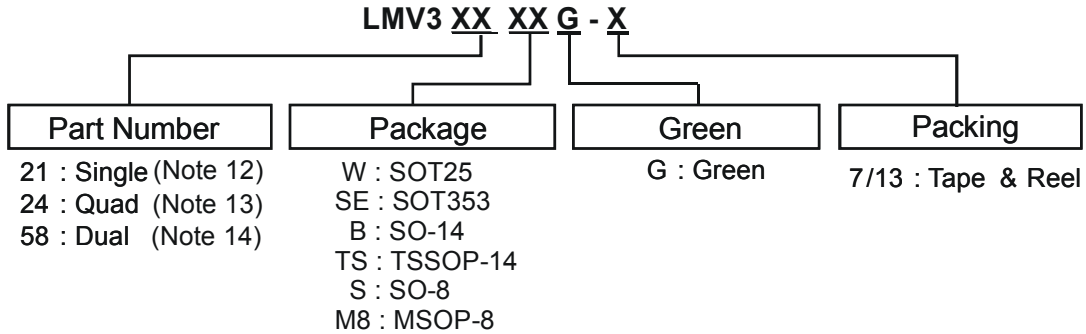

Part Number	Package Code	Packaging	7"/13" Tape and Reel	
			Quantity	Part Number Suffix
LMV321WG-7	W	SOT25	3000/Tape & Reel	-7
LMV321SEG-7	SE	SOT353	3000/Tape & Reel	-7
LMV324BG-13	B	SO-14	2500/Tape & Reel	-13
LMV324TSG-13	TS	TSSOP-14	2500/Tape & Reel	-13
LMV358SG-13	S	SO-8	2500/Tape & Reel	-13
LMV358M8G-13	M8	MSOP-8	2500/Tape & Reel	-13

Notes: 12. LMV321 is only available for SOT25 and SOT353.
 13. LMV324 is only available for SO-14 and TSSOP-14.
 14. LMV358 is only available for SO-8 and MSOP-8.

Marking Information

SOT25/SOT353

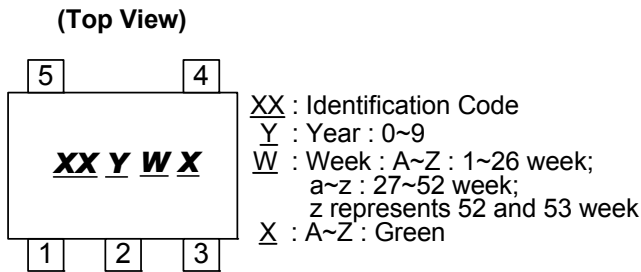

Device	Package type	Identification Code
LMV321W	SOT25	BX
LMV321SE	SOT353	BY

Marking Information (cont.)

SO-14 / TSSOP-14

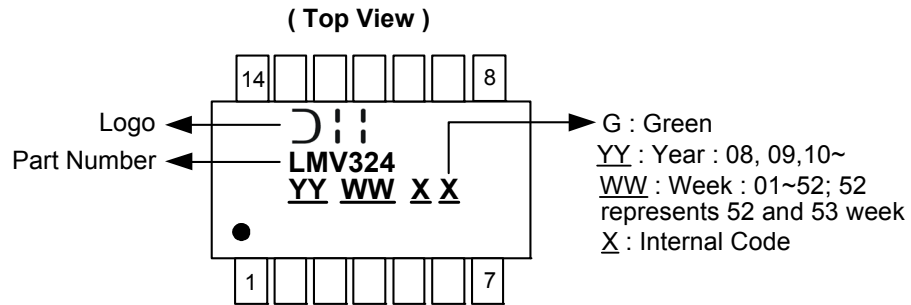

SO-8

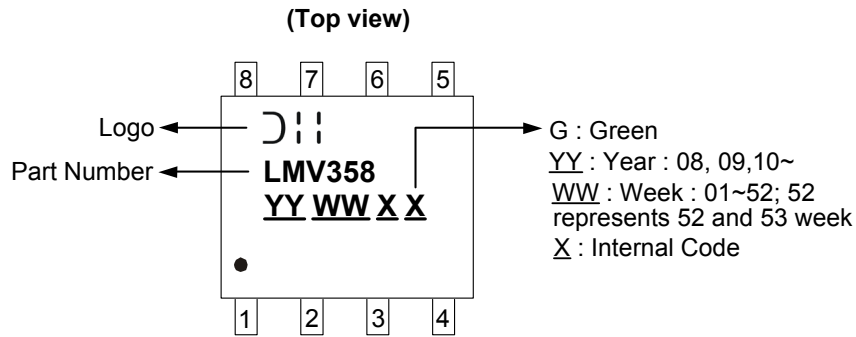

MSOP-8

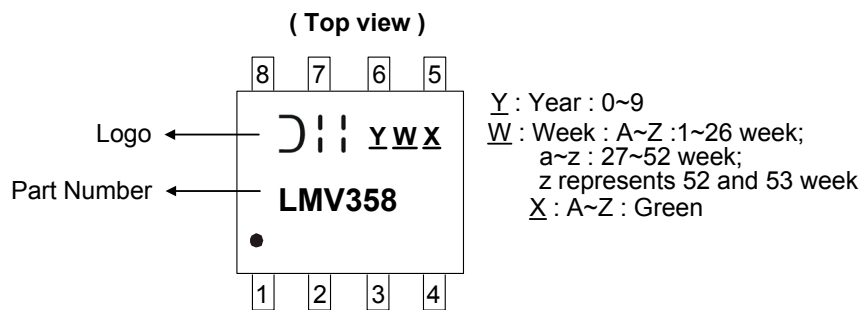

Package Outline Dimensions (All dimensions in mm.)

Please see AP02002 at <http://www.diodes.com/datasheets/ap02002.pdf> for latest version.

SOT25

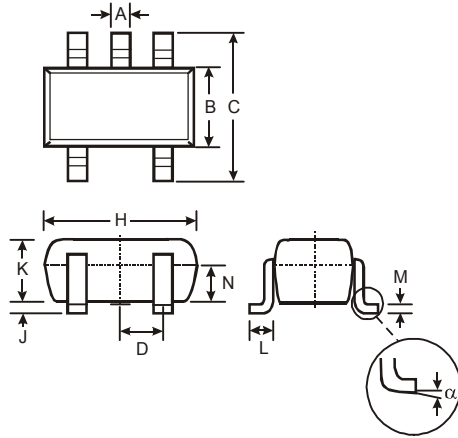

SOT25			
Dim	Min	Max	Typ
A	0.35	0.50	0.38
B	1.50	1.70	1.60
C	2.70	3.00	2.80
D	—	—	0.95
H	2.90	3.10	3.00
J	0.013	0.10	0.05
K	1.00	1.30	1.10
L	0.35	0.55	0.40
M	0.10	0.20	0.15
N	0.70	0.80	0.75
α	0°	8°	—
All Dimensions in mm			

SOT353

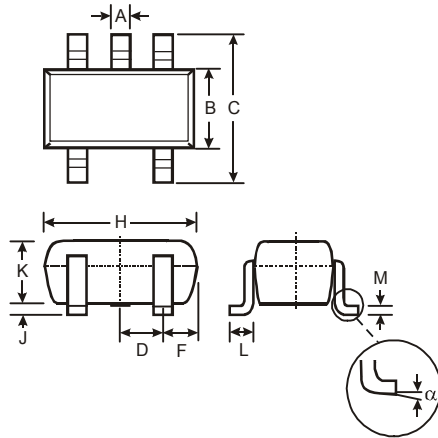

SOT353			
Dim	Min	Max	Typ
A	0.10	0.30	0.25
B	1.15	1.35	1.30
C	2.00	2.20	2.10
D	0.65 Typ		
F	0.40	0.45	0.425
H	1.80	2.20	2.15
J	0	0.10	0.05
K	0.90	1.00	1.00
L	0.25	0.40	0.30
M	0.10	0.22	0.11
α	0°	8°	-
All Dimensions in mm			

SO-14

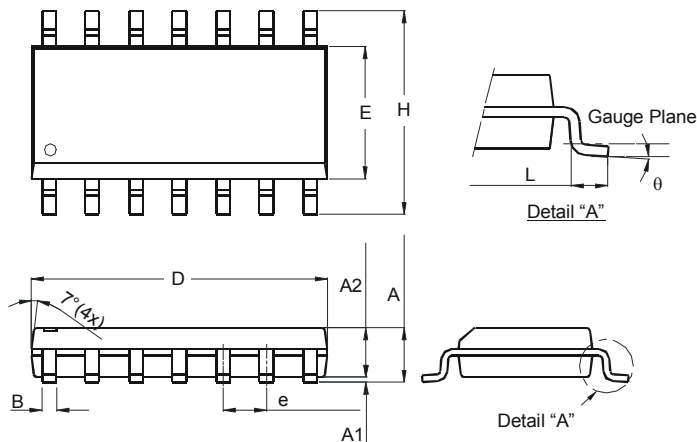

SO-14		
Dim	Min	Max
A	1.47	1.73
A1	0.10	0.25
A2	1.45 Typ	
B	0.33	0.51
D	8.53	8.74
E	3.80	3.99
e	1.27 Typ	
H	5.80	6.20
L	0.38	1.27
θ	0°	8°
All Dimensions in mm		

Package Outline Dimensions (cont.) (All dimensions in mm.)

Please see AP02002 at <http://www.diodes.com/datasheets/ap02002.pdf> for latest version.

TSSOP-14

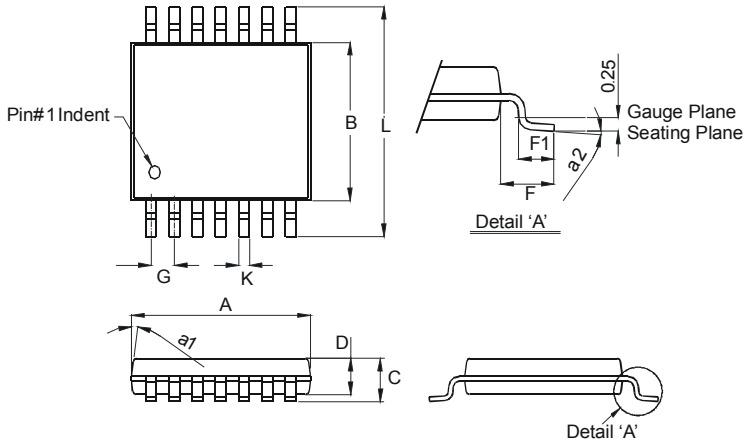

TSSOP-14		
Dim	Min	Max
a1	7° (4X)	
a2	0°	8°
A	4.9	5.10
B	4.30	4.50
C	—	1.2
D	0.8	1.05
F	1.00 Typ	
F1	0.45	0.75
G	0.65 Typ	
K	0.19	0.30
L	6.40 Typ	
All Dimensions in mm		

SO-8

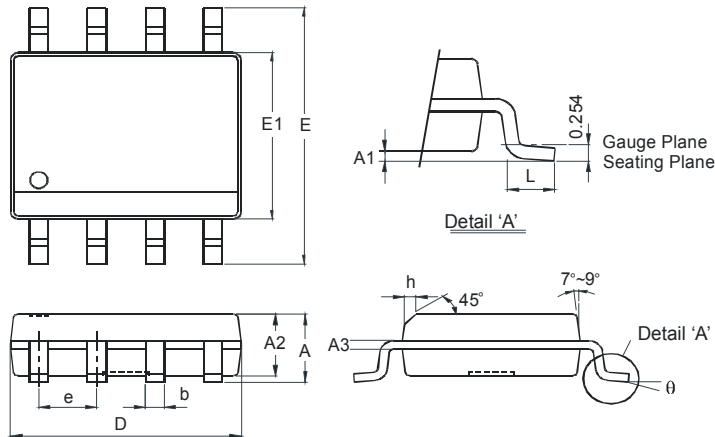

SO-8		
Dim	Min	Max
A	-	1.75
A1	0.10	0.20
A2	1.30	1.50
A3	0.15	0.25
b	0.3	0.5
D	4.85	4.95
E	5.90	6.10
E1	3.85	3.95
e	1.27 Typ	
h	-	0.35
L	0.62	0.82
θ	0°	8°
All Dimensions in mm		

MSOP-8

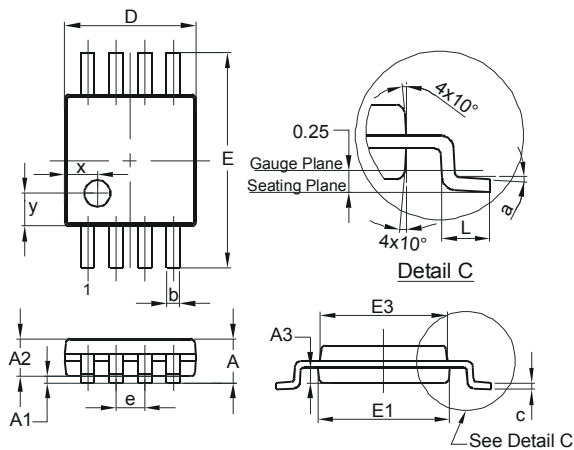

MSOP-8			
Dim	Min	Max	Typ
A	-	1.10	-
A1	0.05	0.15	0.10
A2	0.75	0.95	0.86
A3	0.29	0.49	0.39
b	0.22	0.38	0.30
c	0.08	0.23	0.15
D	2.90	3.10	3.00
E	4.70	5.10	4.90
E1	2.90	3.10	3.00
E3	2.85	3.05	2.95
e	-	-	0.65
L	0.40	0.80	0.60
a	0°	8°	4°
x	-	-	0.750
y	-	-	0.750
All Dimensions in mm			

Suggested Pad Layout

Please see AP02001 at <http://www.diodes.com/datasheets/ap02001.pdf> for the latest version.

SOT25

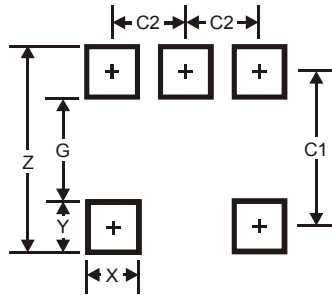

Dimensions	Value (in mm)
Z	3.20
G	1.60
X	0.55
Y	0.80
C1	2.40
C2	0.95

SOT353

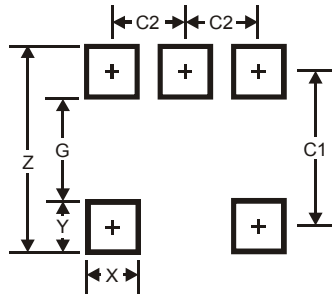

Dimensions	Value (in mm)
Z	2.5
G	1.3
X	0.42
Y	0.6
C1	1.9
C2	0.65

SO-14

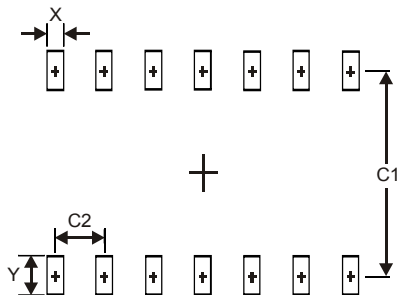

Dimensions	Value (in mm)
X	0.60
Y	1.50
C1	5.4
C2	1.27

TSSOP-14

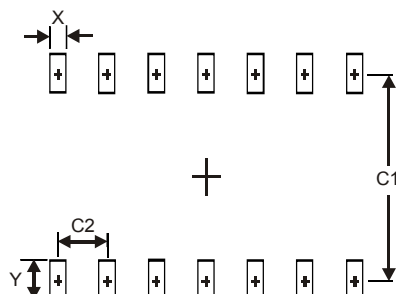

Dimensions	Value (in mm)
X	0.45
Y	1.45
C1	5.9
C2	0.65

Suggested Pad Layout (cont.)

Please see AP02001 at <http://www.diodes.com/datasheets/ap02001.pdf> for the latest version.

SO-8

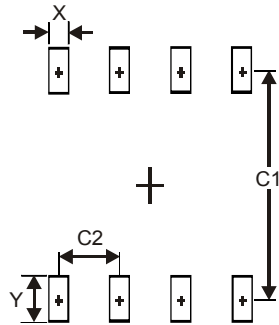

Dimensions	Value (in mm)
X	0.60
Y	1.55
C1	5.4
C2	1.27

MSOP-8

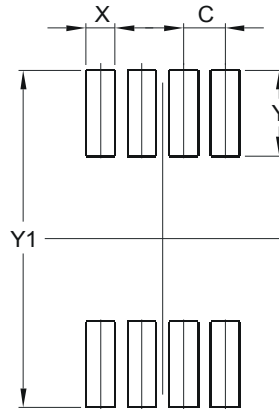

Dimensions	Value (in mm)
C	0.650
X	0.450
Y	1.350
Y1	5.300

IMPORTANT NOTICE

DIODES INCORPORATED MAKES NO WARRANTY OF ANY KIND, EXPRESS OR IMPLIED, WITH REGARDS TO THIS DOCUMENT, INCLUDING, BUT NOT LIMITED TO, THE IMPLIED WARRANTIES OF MERCHANTABILITY AND FITNESS FOR A PARTICULAR PURPOSE (AND THEIR EQUIVALENTS UNDER THE LAWS OF ANY JURISDICTION).

Diodes Incorporated and its subsidiaries reserve the right to make modifications, enhancements, improvements, corrections or other changes without further notice to this document and any product described herein. Diodes Incorporated does not assume any liability arising out of the application or use of this document or any product described herein; neither does Diodes Incorporated convey any license under its patent or trademark rights, nor the rights of others. Any Customer or user of this document or products described herein in such applications shall assume all risks of such use and will agree to hold Diodes Incorporated and all the companies whose products are represented on Diodes Incorporated website, harmless against all damages.

Diodes Incorporated does not warrant or accept any liability whatsoever in respect of any products purchased through unauthorized sales channel. Should Customers purchase or use Diodes Incorporated products for any unintended or unauthorized application, Customers shall indemnify and hold Diodes Incorporated and its representatives harmless against all claims, damages, expenses, and attorney fees arising out of, directly or indirectly, any claim of personal injury or death associated with such unintended or unauthorized application.

Products described herein may be covered by one or more United States, international or foreign patents pending. Product names and markings noted herein may also be covered by one or more United States, international or foreign trademarks.

This document is written in English but may be translated into multiple languages for reference. Only the English version of this document is the final and determinative format released by Diodes Incorporated.

LIFE SUPPORT

Diodes Incorporated products are specifically not authorized for use as critical components in life support devices or systems without the express written approval of the Chief Executive Officer of Diodes Incorporated. As used herein:

A. Life support devices or systems are devices or systems which:

1. are intended to implant into the body, or
2. support or sustain life and whose failure to perform when properly used in accordance with instructions for use provided in the labeling can be reasonably expected to result in significant injury to the user.

B. A critical component is any component in a life support device or system whose failure to perform can be reasonably expected to cause the failure of the life support device or to affect its safety or effectiveness.

Customers represent that they have all necessary expertise in the safety and regulatory ramifications of their life support devices or systems, and acknowledge and agree that they are solely responsible for all legal, regulatory and safety-related requirements concerning their products and any use of Diodes Incorporated products in such safety-critical, life support devices or systems, notwithstanding any devices- or systems-related information or support that may be provided by Diodes Incorporated. Further, Customers must fully indemnify Diodes Incorporated and its representatives against any damages arising out of the use of Diodes Incorporated products in such safety-critical, life support devices or systems.

Copyright © 2013, Diodes Incorporated

www.diodes.com

单击下面可查看定价，库存，交付和生命周期等信息

[>>Diodes Incorporated\(达尔科技\)](#)