

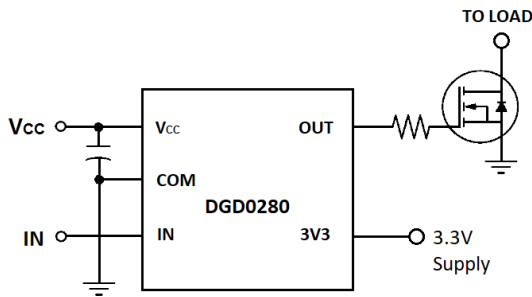
## Description

The DGD0280 high-speed, low-side MOSFET and IGBT driver is capable of driving 1.9A of peak current. The DGD0280 logic inputs are compatible with standard TTL and CMOS levels (down to 3.3V) to interface easily with MCUs. Internal undervoltage lockout (UVLO) protects the MOSFET with loss of supply by turning off the output when VCC falls below operating range. Fast and well matched propagation delays allow high-speed operation, enabling a smaller, more compact power-switching design using smaller associated components.

The DGD0280 has an integrated LDO that outputs 3.3V at ±1% tolerance with the ability to supply 15mA. The DGD0280 provides a non-inverted output. The DGD0280 comes in a space-saving TSOT25 package and operates over an extended -40°C to +125°C temperature range.

## Applications

- DC-DC Converters
- Line Drivers
- Motor Controls
- Switch Mode Power Supplies



Typical Configuration

## Features

- Efficient Low Cost Solution for Driving MOSFETs and IGBTs
- Integrated LDO (3.3V, 15mA Output)
- 3.3V LDO at 1% Accuracy at 25°C
- Wide Supply Voltage Operating Range: 4.5V to 18V
- 2.5A Source / 2.8A Sink Output Current Capability
- Undervoltage Lockout for Vcc Supply
- Fast Propagation Delay (35ns Typ)
- Fast Rise and Fall Times (20ns Typ)
- Logic Input (IN) 3.3V Capability
- Extended Temperature Range: -40°C to +125°C
- **Totally Lead-Free & Fully RoHS Compliant (Notes 1 & 2)**
- **Halogen and Antimony Free. "Green" Device (Note 3)**

## Mechanical Data

- Case: TSOT25
- Case Material: Molded Plastic. "Green" Molding Compound.
- UL Flammability Classification Rating 94V-0
- Moisture Sensitivity: Level 3 per J-STD-020
- Terminals: Finish—Matte Tin Plated Leads. Solderable per MIL-STD-202, Method 208 (e3)
- Weight: 0.016 grams (Approximate)



TSOT25

## Ordering Information (Note 4)

Part number	Marking	Reel Size (inches)	Tape Width (mm)	Quantity per Reel
DGD0280WT-7	D0280	7	8	3000

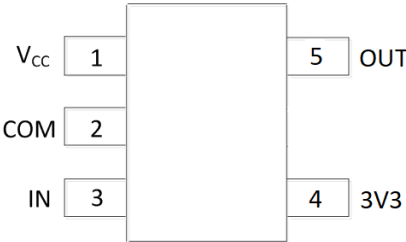
- Notes:
1. No purposely added lead. Fully EU Directive 2002/95/EC (RoHS), 2011/65/EU (RoHS 2) & 2015/863/EU (RoHS 3) compliant.
  2. See <https://www.diodes.com/quality/lead-free/> for more information about Diodes Incorporated's definitions of Halogen- and Antimony-free, "Green" and Lead-free.
  3. Halogen- and Antimony-free "Green" products are defined as those which contain <900ppm bromine, <900ppm chlorine (<1500ppm total Br + Cl) and <1000ppm antimony compounds.
  4. For packaging details, go to our website at <http://www.diodes.com/products/packages.html>.

## Marking Information



D0280 = Product Type Marking Code  
 YY = Year (ex: 19 = 2019)  
 WW or WW - = Week (01 - 53)

**Pin Diagrams**

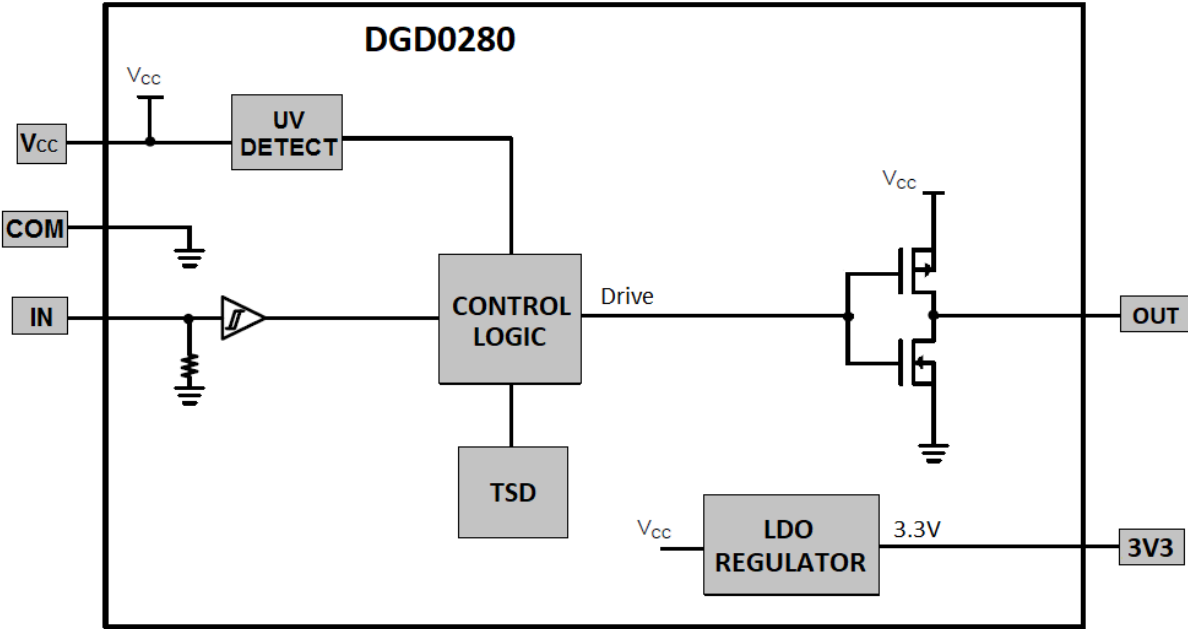


Top View TSOT25

**Pin Descriptions**

Pin Number	Pin Name	Function
1	V <sub>CC</sub>	Supply Input
2	COM	Supply Return
3	IN	Logic Input, In Phase with OUT
4	3V3	LDO Regulator 3.3V Output
5	OUT	Gate Drive Output

**Functional Block Diagram**



**Absolute Maximum Ratings** (@T<sub>A</sub> = +25°C, unless otherwise specified.)

Characteristic	Symbol	Value	Unit
Low-Side Fixed Supply Voltage	V <sub>CC</sub>	-0.3 to +22	V
Output Voltage (OUT)	V <sub>OUT</sub>	-0.3 to V <sub>CC</sub> +0.3	V
Logic Input Voltage (IN)	V <sub>IN</sub>	-5 to V <sub>CC</sub> +0.3	V

**Thermal Characteristics** (@T<sub>A</sub> = +25°C, unless otherwise specified.)

Characteristic	Symbol	Value	Unit
Power Dissipation Linear Derating Factor (Note 5)	P <sub>D</sub>	0.89	W
Thermal Resistance, Junction to Ambient (Note 5)	R <sub>θJA</sub>	117	°C/W
Thermal Resistance, Junction to Case (Note 5)	R <sub>θJC</sub>	12.5	°C/W
Operating Temperature	T <sub>J</sub>	+150	°C
Lead Temperature (Soldering, 10s)	T <sub>L</sub>	+300	
Storage Temperature Range	T <sub>STG</sub>	-55 to +150	

Note: 5. When mounted on a standard JEDEC 2-layer FR-4 board with minimum recommended pad layout.

**ESD Ratings** (Note 6)

Characteristic	Symbol	Value	Unit	JEDEC Class
Electrostatic Discharge – Human Body Model	ESD HBM	2000	V	2
Electrostatic Discharge – Charged Device Model	ESD CDM	1000	V	IV

Note: 6. Refer to JEDEC specification JESD22-A114 and JESD22-C101.

**Recommended Operating Conditions**

Parameter	Symbol	Min	Max	Unit
Supply Voltage	V <sub>CC</sub>	4.5	18	V
Output Voltage (OUT)	V <sub>OUT</sub>	0	V <sub>CC</sub>	V
Logic Input Voltage (IN)	V <sub>IN</sub>	0	5	V
Ambient Temperature	T <sub>A</sub>	-40	+125	°C

**DC Electrical Characteristics** ( $V_{CC} = 12V$ ,  $@T_A = +25^\circ C$ , unless otherwise specified.) (Note 7)

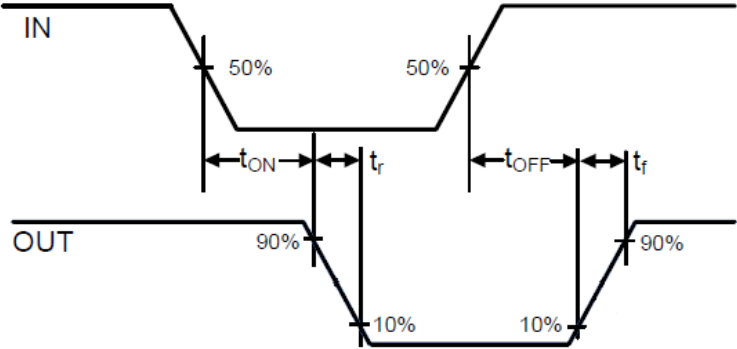
Parameter	Symbol	Min	Typ	Max	Unit	Conditions
Logic "1" Input Voltage	$V_{IH}$	2.0	—	—	V	—
Logic "0" Input Voltage	$V_{IL}$	—	—	0.8	V	—
Input Hysteresis	$V_{IN\_HYS}$	—	0.5	—	V	—
Logic "1" Input Bias Current	$I_{IN+}$	—	7.5	20	$\mu A$	$V_{IN} = 3V$
Logic "0" Input Bias Current	$I_{IN-}$	—	—	1	$\mu A$	$V_{IN} = 0V$
Quiescent $V_{CC}$ Supply Current	$I_{CCQ}$	—	—	250	$\mu A$	Inputs Open
Operating $V_{CC}$ Supply Current	$I_{CCO}$	—	1.5	—	mA	$f_s = 100kHz$ $C_L = 1000pF$
		—	12.5	—		$f_s = 1MHz$ $C_L = 1000pF$
$V_{CC}$ Supply Undervoltage Positive Going Threshold	$V_{CCUV+}$	4.5	4.75	5.0	V	—
$V_{CC}$ Supply Undervoltage Negative Going Threshold	$V_{CCUV-}$	4.2	4.5	4.8	V	—
Output High Short-Circuit Pulsed Current	$I_{O+}$	—	2.5	—	A	$V_O = 0V$ , $PW \leq 10\mu s$
Output Low Short-Circuit Pulsed Current	$I_{O-}$	—	2.8	—	A	$V_O = 15V$ , $PW \leq 10\mu s$
LDO Output Voltage	$V_{LDO}$	3.267	3.3	3.333	V	$I_{OUT} = 10mA$
LDO Line Regulation	$V_{LDO\_LINE}$	—	21	38	mV	$V_{CC} = 5V$ to $18V$ , $I_{OUT} = 10mA$
LDO Load Regulation	$V_{LDO\_LOAD}$	—	—	10	mV	$V_{CC} = 12V$ , $I_{OUT} = 0.1mA$ to $10mA$
Maximum LDO Current	$I_{LDO\_MAX}$	—	15	—	mA	$R_L = 220\Omega$
LDO Current Limit	$I_{LDO\_LIM}$	20	68	—	mA	$R_L = 0\Omega$
Thermal Shutdown Turn On	$TSD_{ON}$	—	150	—	$^\circ C$	—
Thermal Shutdown Turn Off	$TSD_{OFF}$	—	125	—	$^\circ C$	—

Note: 7. The  $V_{IN}$  and  $I_{IN}$  parameters are applicable to the logic input pin: IN. The  $V_O$  and  $I_O$  parameters are applicable to the output pin: OUT.

**AC Electrical Characteristics** ( $V_{CC} = 12V$ ,  $@T_A = +25^\circ C$ , unless otherwise specified.)

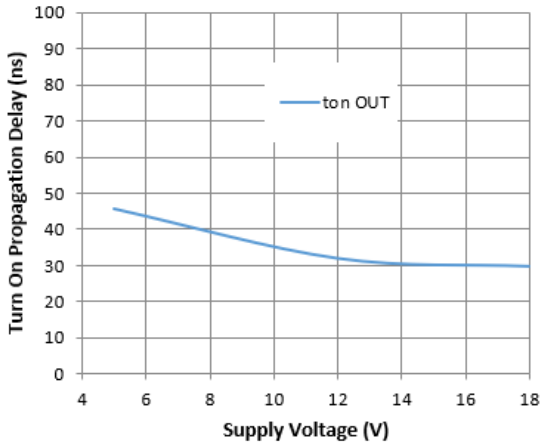
Parameter	Symbol	Min	Typ	Max	Unit	Conditions
Turn-on Rise Time	$t_r$	—	20	35	ns	$C_L = 1000pF$
Turn-off Fall Time	$t_f$	—	15	35	ns	$C_L = 1000pF$
Turn-on Propagation Delay	$t_{ON}$	20	35	50	ns	—
Turn-off Propagation Delay	$t_{OFF}$	15	30	50	ns	—

**Timing Waveforms**

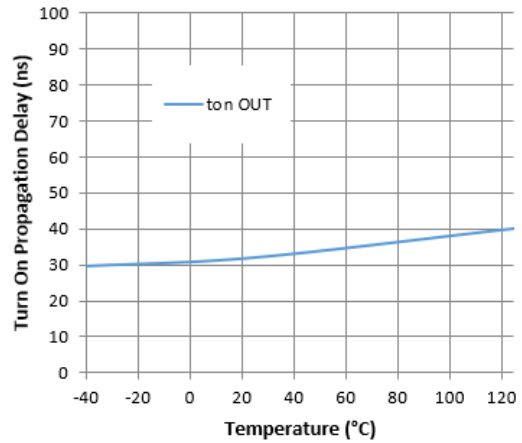


**Figure 1.** Switching Time Waveform Definitions

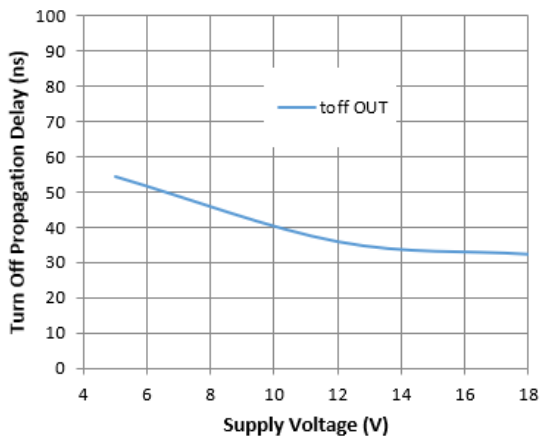
**Typical Performance Characteristics** ( $V_{CC} = 12V$ ,  $@T_A = +25^\circ C$ , unless otherwise specified.)



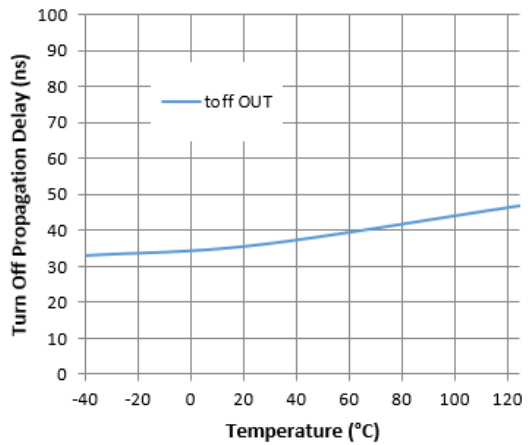
**Figure 2.** Turn-on Propagation Delay vs. Supply Voltage



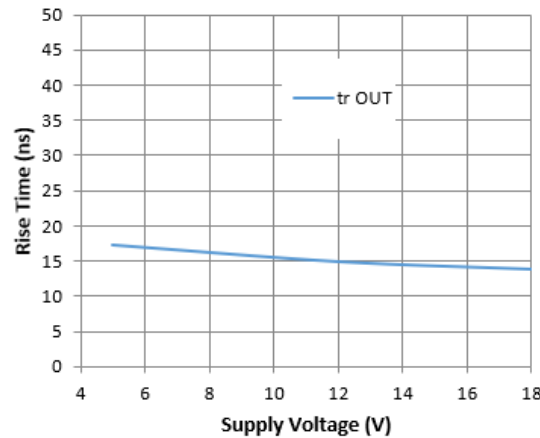
**Figure 3.** Turn-on Propagation Delay vs. Temperature



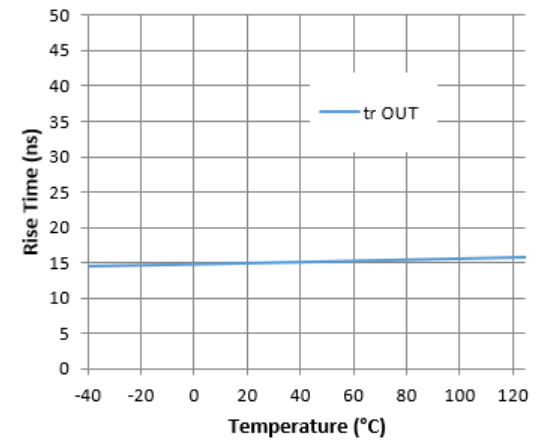
**Figure 4.** Turn-off Propagation Delay vs. Supply Voltage



**Figure 5.** Turn-off Propagation Delay vs. Temperature

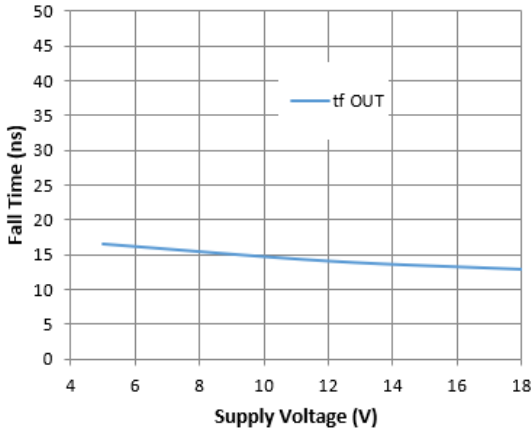


**Figure 6.** Rise Time vs. Supply Voltage

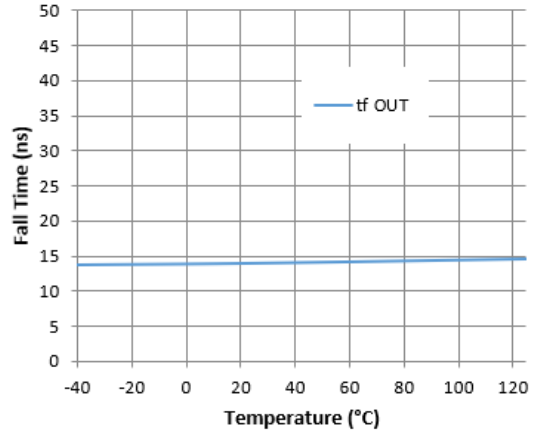


**Figure 7.** Rise Time vs. Temperature

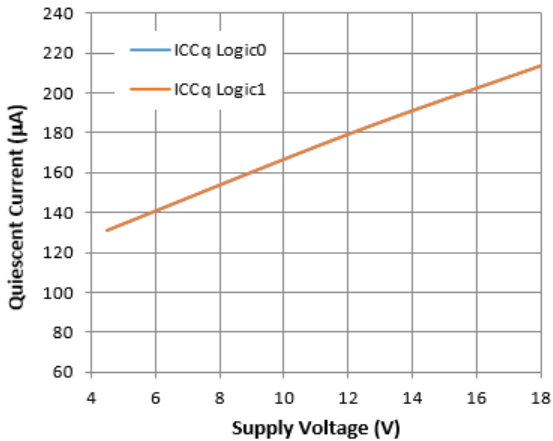
**Typical Performance Characteristics** (continued)



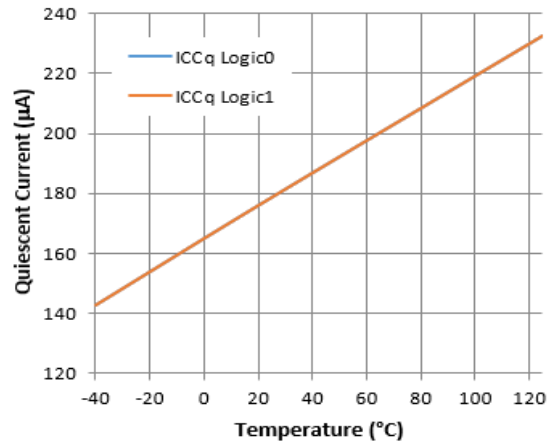
**Figure 8.** Fall Time vs. Supply Voltage



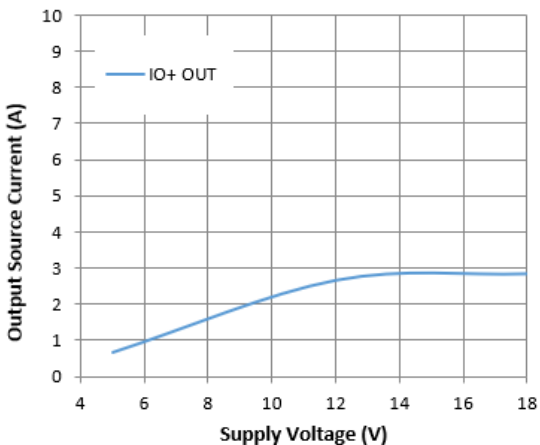
**Figure 9.** Fall Time vs. Temperature



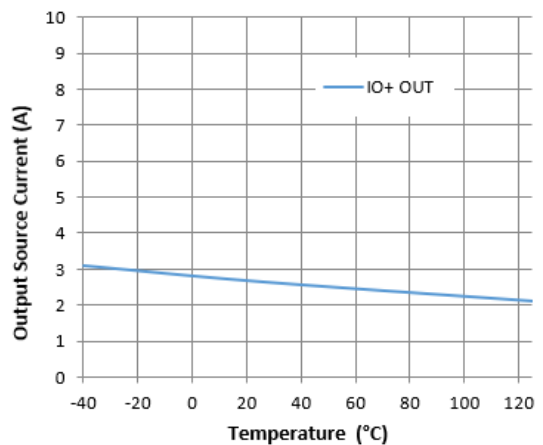
**Figure 10.** Quiescent Current vs. Supply Voltage



**Figure 11.** Quiescent Current vs. Temperature

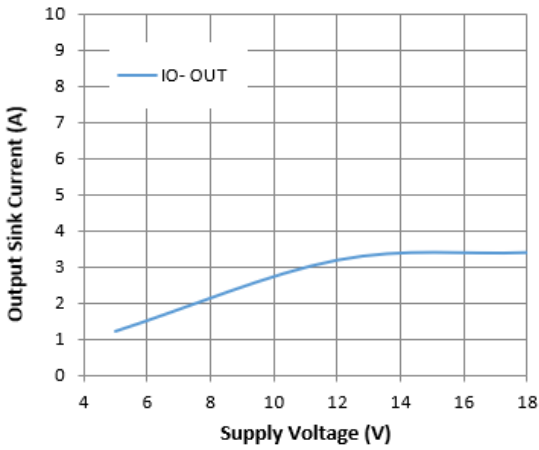


**Figure 12.** Output Source Current vs. Supply Voltage

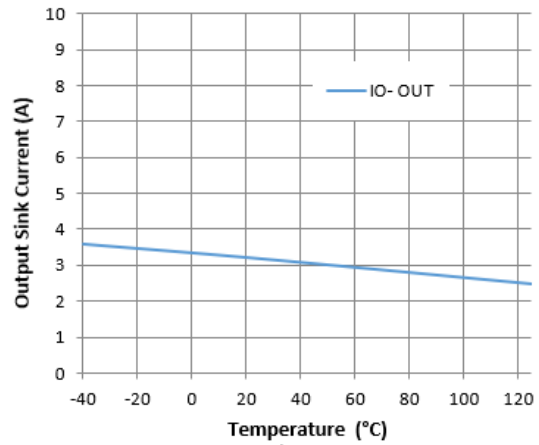


**Figure 13.** Output Source Current vs. Temperature

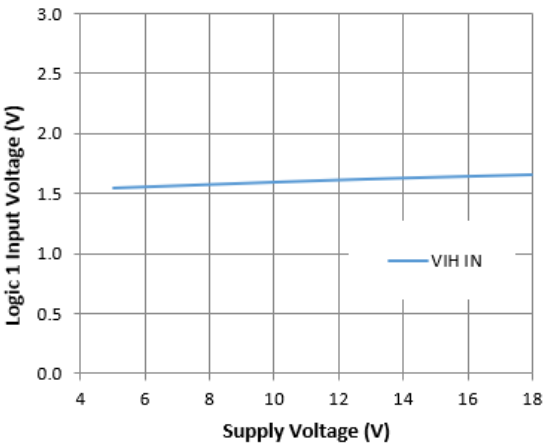
**Typical Performance Characteristics** (cont.)



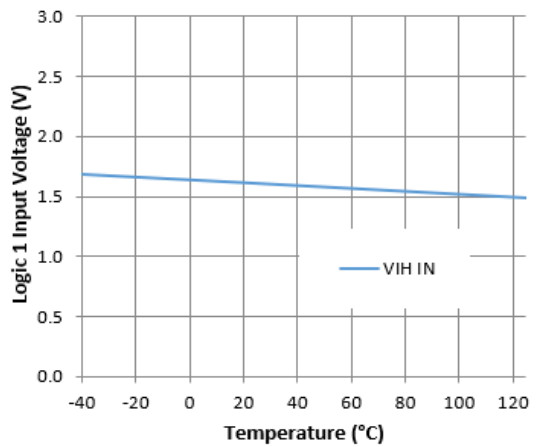
**Figure 14.** Output Sink Current vs. Supply Voltage



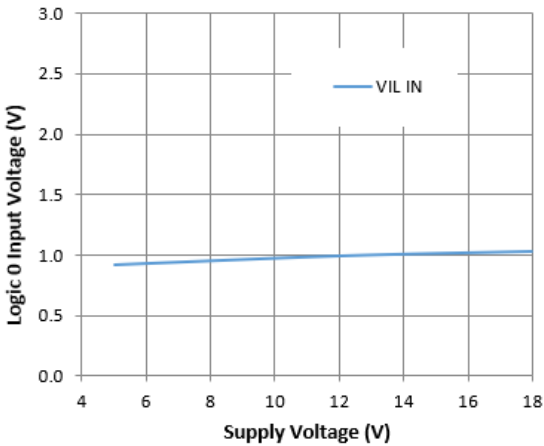
**Figure 15.** Output Sink Current vs. Temperature



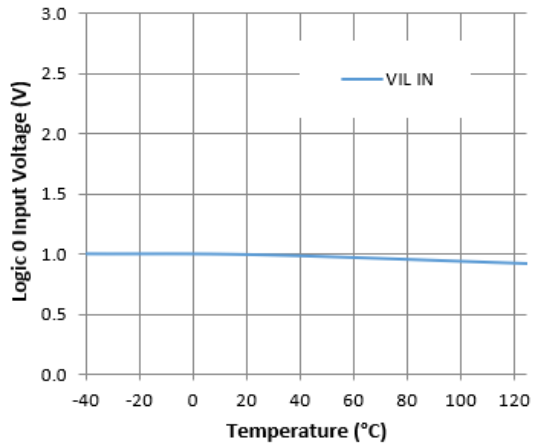
**Figure 16.** Logic 1 Input Voltage vs. Supply Voltage



**Figure 17.** Logic 1 Input Voltage vs. Temperature



**Figure 18.** Logic 0 Input Voltage vs. Supply Voltage



**Figure 19.** Logic 0 Input Voltage vs. Temperature



**Typical Performance Characteristics** (cont.)

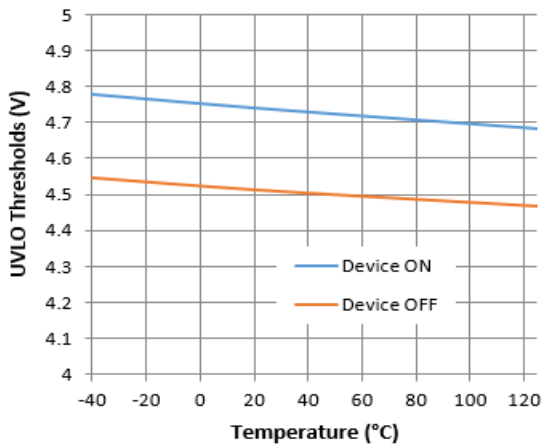


Figure 20. UVLO Thresholds vs. Temperature

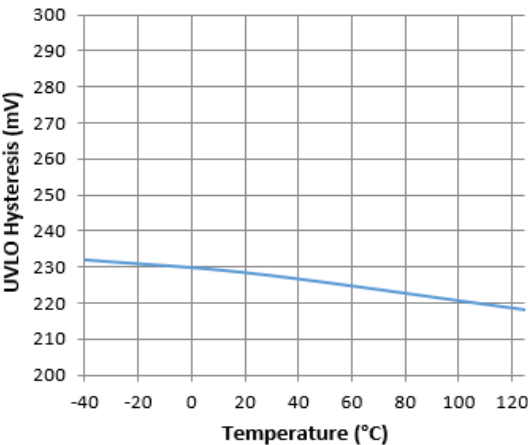
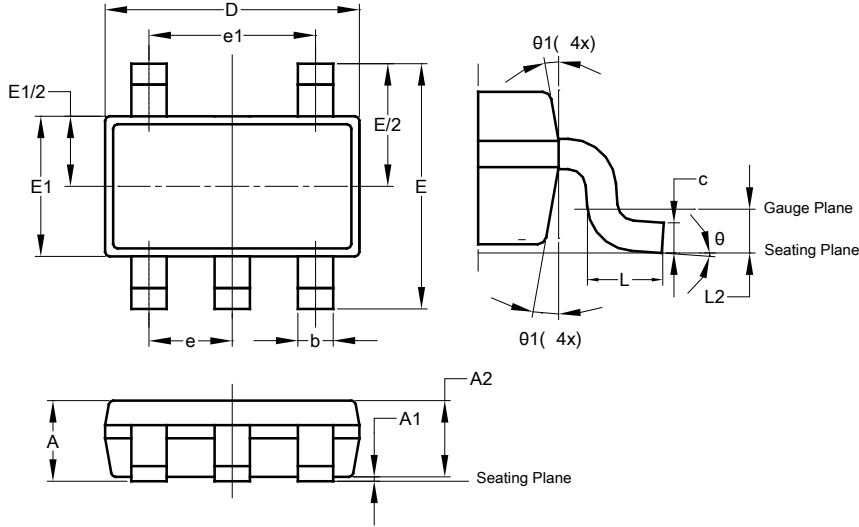


Figure 21. UVLO Hysteresis vs. Temperature

**Package Outline Dimensions**

Please see <http://www.diodes.com/package-outlines.html> for the latest version.

**TSOT25**

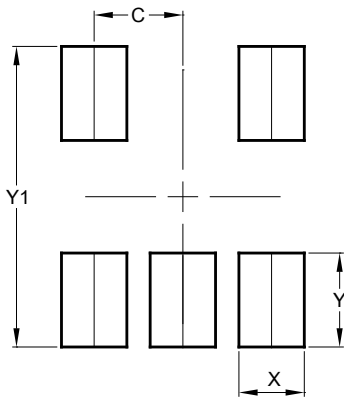


TSOT25			
Dim	Min	Max	Typ
A	—	1.00	—
A1	0.01	0.10	—
A2	0.84	0.90	—
b	0.30	0.45	—
c	0.12	0.20	—
D	—	—	2.90
E	—	—	2.80
E1	—	—	1.60
e	0.95 BSC		
e1	1.90 BSC		
L	0.30	0.50	—
L2	0.25 BSC		
theta	0°	8°	4°
theta1	4°	12°	—
All Dimensions in mm			

**Suggested Pad Layout**

Please see <http://www.diodes.com/package-outlines.html> for the latest version.

**TSOT25**



Dimensions	Value (in mm)
C	0.950
X	0.700
Y	1.000
Y1	3.199

**IMPORTANT NOTICE**

DIODES INCORPORATED MAKES NO WARRANTY OF ANY KIND, EXPRESS OR IMPLIED, WITH REGARDS TO THIS DOCUMENT, INCLUDING, BUT NOT LIMITED TO, THE IMPLIED WARRANTIES OF MERCHANTABILITY AND FITNESS FOR A PARTICULAR PURPOSE (AND THEIR EQUIVALENTS UNDER THE LAWS OF ANY JURISDICTION).

Diodes Incorporated and its subsidiaries reserve the right to make modifications, enhancements, improvements, corrections or other changes without further notice to this document and any product described herein. Diodes Incorporated does not assume any liability arising out of the application or use of this document or any product described herein; neither does Diodes Incorporated convey any license under its patent or trademark rights, nor the rights of others. Any Customer or user of this document or products described herein in such applications shall assume all risks of such use and will agree to hold Diodes Incorporated and all the companies whose products are represented on Diodes Incorporated website, harmless against all damages.

Diodes Incorporated does not warrant or accept any liability whatsoever in respect of any products purchased through unauthorized sales channel. Should Customers purchase or use Diodes Incorporated products for any unintended or unauthorized application, Customers shall indemnify and hold Diodes Incorporated and its representatives harmless against all claims, damages, expenses, and attorney fees arising out of, directly or indirectly, any claim of personal injury or death associated with such unintended or unauthorized application.

Products described herein may be covered by one or more United States, international or foreign patents pending. Product names and markings noted herein may also be covered by one or more United States, international or foreign trademarks.

This document is written in English but may be translated into multiple languages for reference. Only the English version of this document is the final and determinative format released by Diodes Incorporated.

**LIFE SUPPORT**

Diodes Incorporated products are specifically not authorized for use as critical components in life support devices or systems without the express written approval of the Chief Executive Officer of Diodes Incorporated. As used herein:

A. Life support devices or systems are devices or systems which:

1. are intended to implant into the body, or
2. support or sustain life and whose failure to perform when properly used in accordance with instructions for use provided in the labeling can be reasonably expected to result in significant injury to the user.

B. A critical component is any component in a life support device or system whose failure to perform can be reasonably expected to cause the failure of the life support device or to affect its safety or effectiveness.

Customers represent that they have all necessary expertise in the safety and regulatory ramifications of their life support devices or systems, and acknowledge and agree that they are solely responsible for all legal, regulatory and safety-related requirements concerning their products and any use of Diodes Incorporated products in such safety-critical, life support devices or systems, notwithstanding any devices- or systems-related information or support that may be provided by Diodes Incorporated. Further, Customers must fully indemnify Diodes Incorporated and its representatives against any damages arising out of the use of Diodes Incorporated products in such safety-critical, life support devices or systems.

Copyright © 2019, Diodes Incorporated

[www.diodes.com](http://www.diodes.com)

单击下面可查看定价，库存，交付和生命周期等信息

[>>Diodes Incorporated\(达达科技\(美台\)\)](#)