

### Features

- High efficiency synchronous step-down converter with greater than 94%
- Current Mode Operation for faster transient response and better loop stabilization
- 2.5V to 5.5V operating input voltage range
- Adjustable output voltage range from 0.8V to  $V_{IN}$
- Fixed output voltage options: 1.8V, 2.5V and 3.3V
- Up to 800mA output current
- High efficiency over a wide range of load currents
- PWM operation mode
- Internal soft-start function
- Typical quiescent current of 150 $\mu$ A
- MSOP-10L: Available in "Green" Molding Compound (No Br, Sb)
- Lead Free Finish/ RoHS Compliant (Note 1)

### General Description

The AP6015 is the first device in a family of low-noise current mode synchronous step-down DC-DC converters. It is ideally suited for systems powered by either a 1-cell Li-ion battery or a 2- to 3-cell NiCd/ NiMH/ Alkaline battery.

The AP6015 is a synchronous PWM converter with integrated N- and P-channel power MOSFET switches. Compared to the asynchronous topology, synchronous rectification offers the benefits of higher efficiency and reduced component count. The high operating frequency of 1MHz allows small inductor and capacitor to be used. This results in small pcb area. During shut-down, the standby current drops to 1 $\mu$ A or less. The AP6015 is available in the 10-pin MSOP package. It operates over a free-air temperature range of -40°C to 85°C.

### Applications

- Mobile Handsets
- PDAs, Ultra Mobile PCs
- Portable Media Players, Digital Still/Video Cameras
- USB-based DSL Modems
- LAN/WLAN/WPAN/WWAN Modules

### Ordering Information

#### AP 6015 - XX M10 G - 13

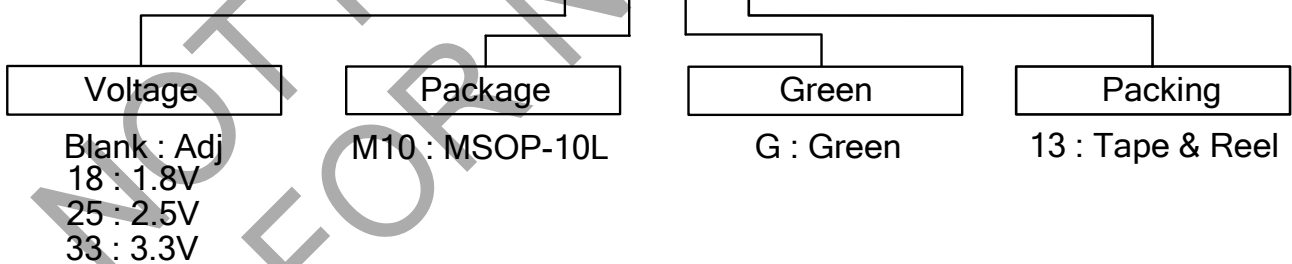

Device	Package Code	Packaging (Note 2)	13" Tape and Reel	
			Quantity	Part Number Suffix
AP6015-XXM10G-13	M10	MSOP-10L	2500/Tape & Reel	-13

Notes: 1. EU Directive 2002/95/EC (RoHS). All applicable RoHS exemptions applied, see *EU Directive 2002/95/EC Annex Notes*.  
2. Pad layout as shown on Diodes Inc. suggested pad layout document AP02001, which can be found on our website at <http://www.diodes.com/datasheets/ap02001.pdf>.

## Pin Assignment

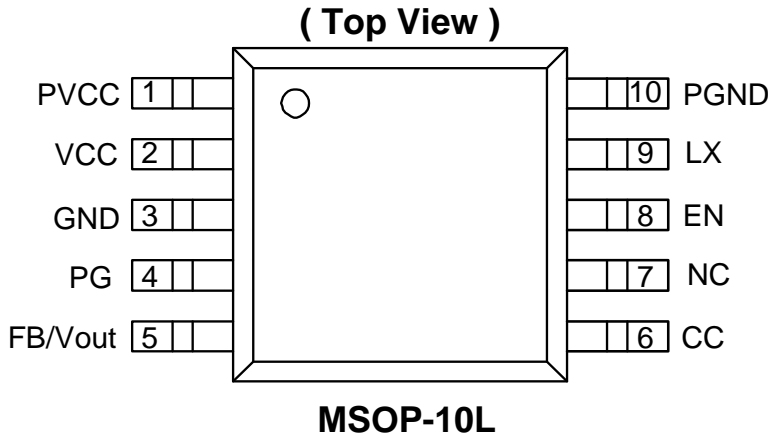

## Pin Descriptions

Pin Name	Pin NO.	I/O	Description
PVCC	1	I	Supply voltage input
VCC	2		Supply bypass pin. A 1 $\mu$ F coupling capacitor should be connected as close as possible to this pin.
GND	3		Ground
PG	4	O	Power good comparator output. A pull-up resistor should be connected between PG and V <sub>o</sub> .
FB	5	I	Feedback pin for the fixed output voltage option.
CC	6	I	Compensation pin
NC	7	NC	No connect
EN	8	I	Enable. Pin, H: Enable. L: shutdown
LX	9	I/O	Connect the inductor to this pin.
PGND	10		Power ground

**Block Diagram**

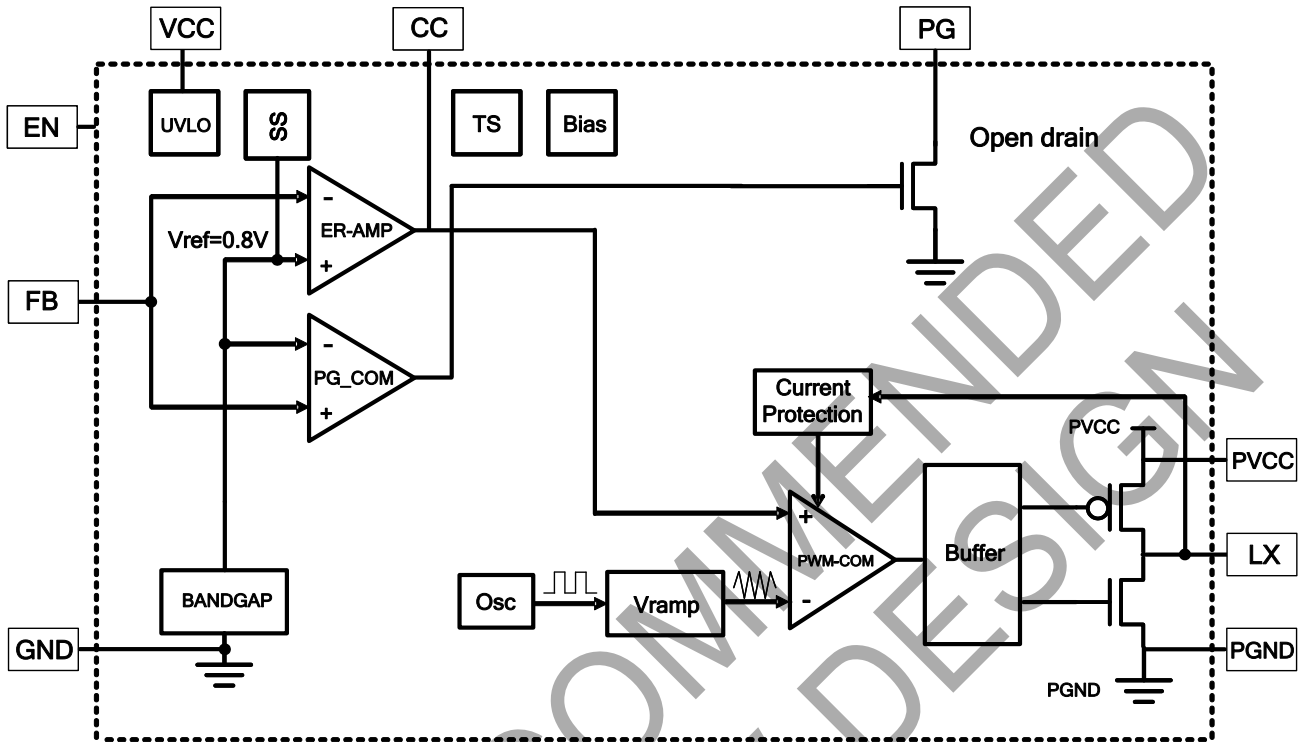

Notes: 3. The adjustable output voltage version does not use the internal feedback resistor divider. The FB pin is directly connected to the error amplifier.

**Absolute Maximum Ratings**

Symbol	Parameter	Rating	Unit
ESD HBM	Human Body Model ESD Protection	2.5	KV
ESD MM	Machine Model ESD Protection	300	V
PVCC, VCC	Supply Voltage	-0.3 to +5.5	V
	Voltages on pins EN, CC, PG, FB, LX	-0.3 to $V_{IN} + 0.3$	V
$T_{J(MAX)}$	Maximum Junction Temperature Range	+150	°C
$T_{ST}$	Storage temperature range	-65 to +150	°C
$T_{OP}$	Operating Junction Temperature Range	-40 to +125	°C

Stresses beyond those listed under "absolute maximum ratings" may cause permanent damage to the device. These are stress ratings only and functional operation of the device at these or any other conditions beyond those indicated under "recommended operating conditions" is not implied. Exposure to absolute-maximum-rated conditions for extended periods may affect device reliability.

### Recommended Operating Conditions (T<sub>A</sub> :-40~85°C)

Symbol	Parameter	Rating	Unit
T <sub>A</sub>	Operating Ambient Temperature Range	-40 to +85	°C
V <sub>IN</sub>	Supply Voltage	2.0 to 5.5	V
V <sub>O</sub>	Output voltage range for adjustable output voltage version	0.8 to V <sub>I</sub>	V
L	Inductor (see Note 4)	3.3	μH
C <sub>i</sub>	Input capacitor (see Note 4)	10	μF
C <sub>o</sub>	Output capacitor (see Note 4) V <sub>O</sub> ≥ 1.8V	10	μF

Notes: 4. Refer to application section for further information.

### Electrical Characteristics (T<sub>A</sub> =25°C)

Over recommended operating free-air temperature range, V<sub>I</sub>=3.6V, V<sub>O</sub>=2.5V, I<sub>O</sub>=300mA, EN=V<sub>IN</sub>. (unless otherwise noted)

Symbol	Parameter	Conditions	Min	Typ.	Max	Unit	
Supply current							
V <sub>IN</sub>	Input Voltage range	-20 to 85 °C	I <sub>O</sub> = 0mA to 800mA	2.5	-	5.5	V
			I <sub>O</sub> = 0mA to 500mA	2	-	5.5	
		-40 to 85 °C	I <sub>O</sub> = 0mA to 600mA	2.5	-	5.5	
			I <sub>O</sub> = 0mA to 400mA	2	-	-	
I <sub>CCQ</sub>	Operating quiescent current	I <sub>O</sub> = 0mA	-	150	-	μA	
I <sub>STBY</sub>	Standby current	EN= GND	-	0.1	1	μA	
Enable							
V <sub>IH</sub>	EN high-level input voltage	V <sub>IN</sub> ≤ 3V	1.5	-	-	V	
		V <sub>IN</sub> > 3V	2.5	-	-		
V <sub>IL</sub>	EN low-level input voltage		-	-	0.7	V	
I <sub>L</sub>	EN input leakage current	EN= GND or V <sub>IN</sub>	-	0.01	0.1	μA	
V <sub>(UVLO)</sub>	Under-voltage-lockout-threshold		1.2	1.6	1.95	V	

### Electrical Characteristics (Continued)

Over recommended operating free-air temperature range,  $V_I=3.6V$ ,  $V_O=2.5V$ ,  $I_O=300mA$ ,  $EN=V_{IN}$ . (unless otherwise noted)

Symbol	Parameter	Conditions	Min	Typ.	Max	Unit	
<b>Power switch and current limit</b>							
$R_{DS(on)}$	P-channel MOSFET on-resistance	$V_I=V_{GS}=3.6V$ ; $I=200mA$	200	280	410	mΩ	
		$V_I=V_{GS}=2V$ ; $I=200mA$	-	480	-		
	P-channel leakage current	$V_{DS}=5.5V$	-	-	1	μA	
$I_{(LIM)}$	P-channel current limit	$2.5V \leq V_I \leq 5.5V$	1200	-	1600	mA	
<b>Power good output (see Note 5)</b>							
$V_{(PG)}$	Power good threshold	Feedback voltage falling	88% $V_O$	92% $V_O$	94% $V_O$	V	
	Power good hysteresis		2.5% $V_O$				
$V_{OL}$	PG output low voltage	$V_{(FB)}=0.8 \times V_O$ nominal; $I_{(sink)}=10\mu A$	-	-	0.3	V	
$I_{LKG}$	PG output leakage current	$V_{(FB)}=V_O$ nominal		0.01	1	μA	
	Minimum supply voltage for valid power good signal		1.2	-	-	V	
<b>Oscillator</b>							
$F_S$	Oscillator frequency		800	1000	1200	KHz	
<b>Output</b>							
$V_O$	Adjustable output voltage range		0.8		5.5	V	
$V_{REF}$	Reference voltage		0.784	0.8	0.816	V	
$V_O$	Fixed output voltage (see Note 6)	AP6015-Adj	$V_I=2.5V$ to $5.5V$ ; $0mA \leq I_O \leq 800mA$	-3%	-	4%	V
		AP6015-1.8V	$10mA \leq I_O \leq 800mA$	-3%	-	3%	
		AP6015-2.5V	$V_I=2.7V$ to $5.5V$ ; $0mA \leq I_O \leq 800mA$	-3%	-	4%	
			$10mA \leq I_O \leq 800mA$	-3%	-	3%	
		AP6015-3.3V	$V_I=3.6V$ to $5.5V$ ; $0mA \leq I_O \leq 800mA$	-3%	-	4%	
$10mA \leq I_O \leq 800mA$	-3%		-	3%			
	Line regulation	$V_I=V_O + 0.5V$ (min.2V) to 6.0V; $I_O=10mA$	0.3			%/V	
	Load regulation	$V_I=5.0V$ ; $I_O=10mA$ to 800mA	0.8			%	
$\eta$	Efficiency	$V_I=5V$ ; $V_O=3.3V$ ; $I_O=300mA$ $V_I=3.6V$ ; $V_O=2.5V$ ; $I_O=200mA$	94			%	
	Start-up time	$I_O=0mA$ , time from active EN to $V_O$	0.4	1	4	ms	
$\theta_{JA}$	Thermal Resistance Junction-to-Ambient	MSOP-10L (Note 7)		161		°C/W	
$\theta_{JC}$	Thermal Resistance Junction-to-Case	MSOP-10L (Note 7)		39		°C/W	

Notes: 5. Power good is not valid for the first 100μs after EN goes high. Please refer to the application section for more information.

6. The output voltage accuracy includes line and load regulation over the full temperature range.

7. Test condition for MSOP-10L: Device mounted on 2oz copper, minimum recommended pad layout on top & bottom layer with thermal vias, double sided FR-4 PCB

## Typical Application Circuit

For best transient response we suggest that  $R_{CC}$ ,  $C_{CC}$  and  $L1$  values as below.

	$R_{CC}$	$C_{CC}$	L1-WURTH	C1, C2 (MLCC)
$V_{IN} < 3.0V, V_{OUT} < 2.5V$	200K $\Omega$	33PF	1.8 $\mu$ H	10 $\mu$ F
$V_{IN} \geq 3.0V, V_{OUT} < 2.5V$	68K $\Omega$	100PF	1.8 $\mu$ H	10 $\mu$ F
$V_{IN} \geq 3.0V, V_{OUT} \geq 2.5V$	82K $\Omega$	100PF	3.3 $\mu$ H	10 $\mu$ F

### (1) ADJ Output

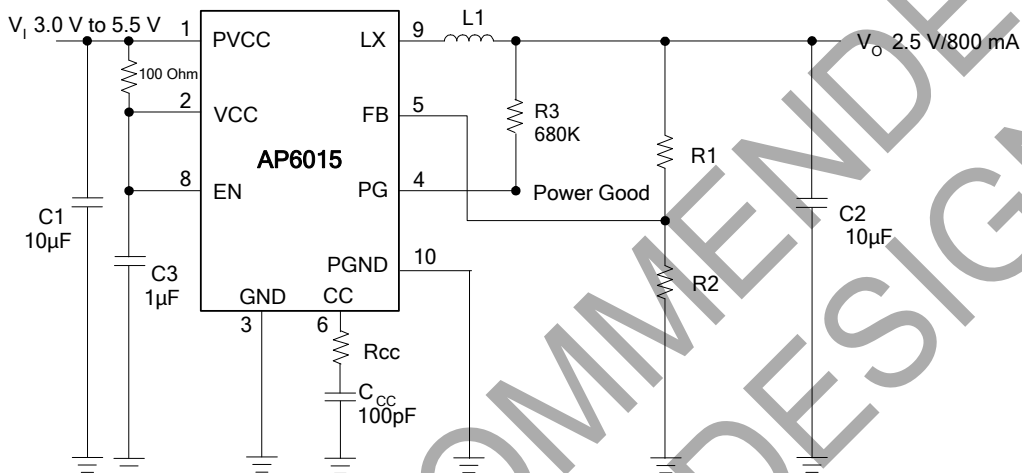

R2: Suggest to be 39K~100K because of stability reasons.

$$V_o = V_{REF} \times \left(1 + \frac{R_1}{R_2}\right)$$

### Typical Application Circuit for Adjustable Output Voltage Option

### (2) FIXED Output

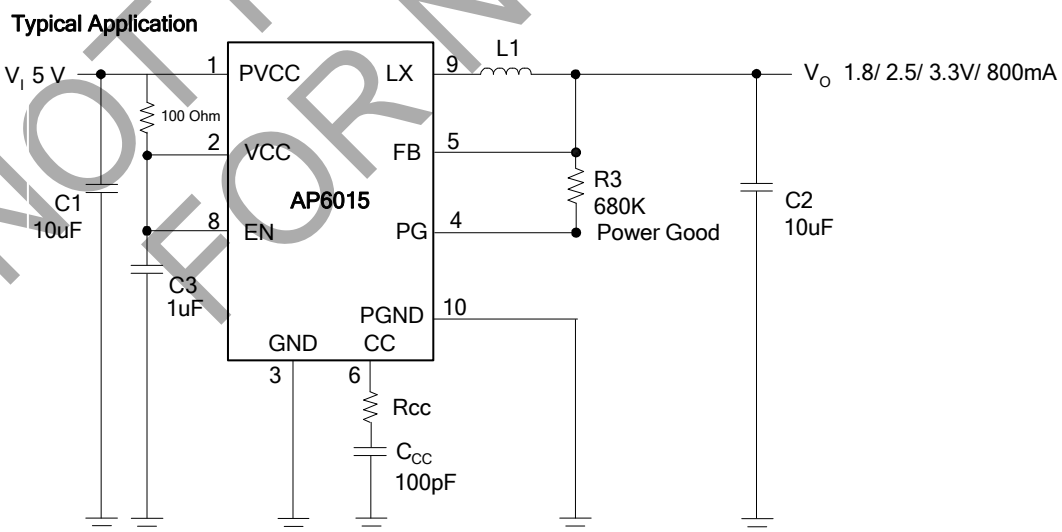

Standard 5 V to 1.8/ 2.5/ 3.3V/ 800mA Conversion; High Efficiency

**Typical Operating Characteristics**

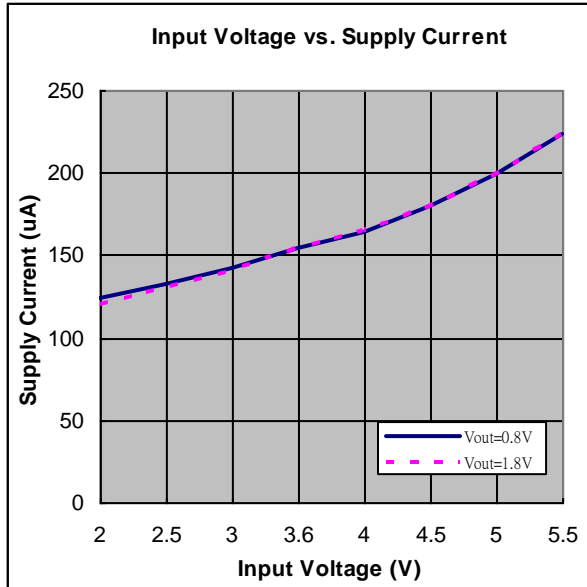

Figure 1

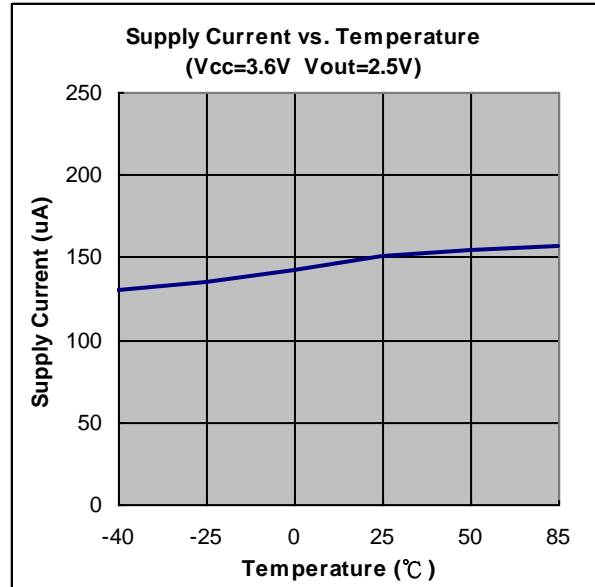

Figure 2

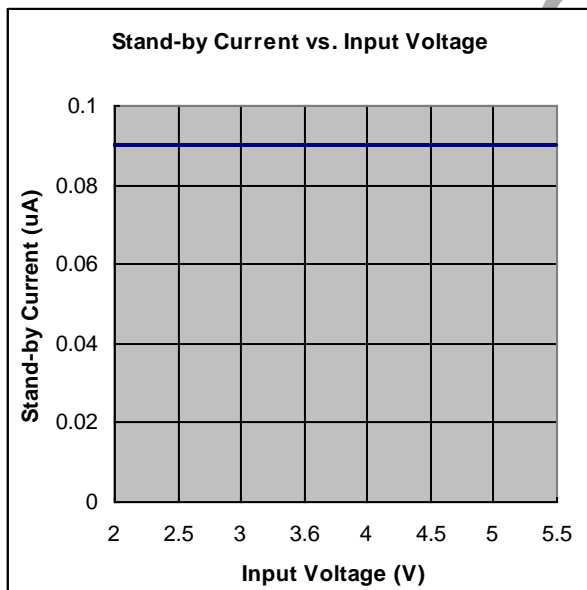

Figure 3

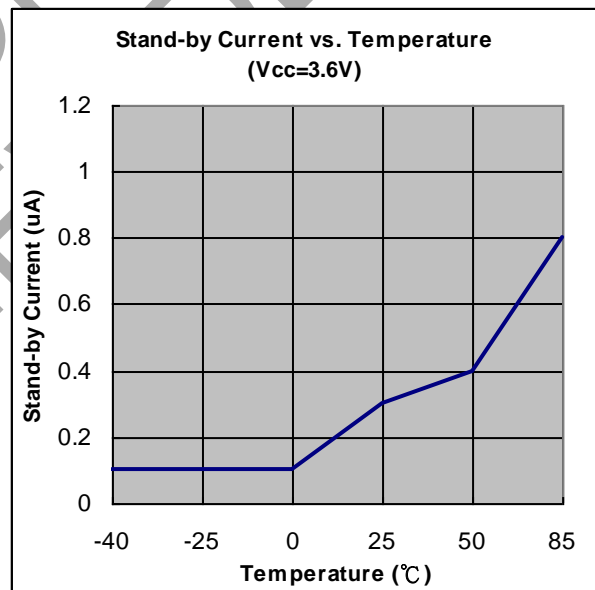

Figure 4

**Typical Operating Characteristics (Continued)**

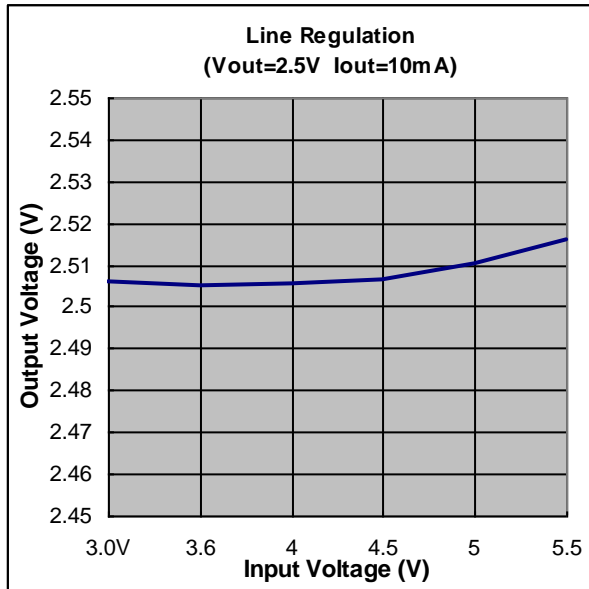

Figure 5

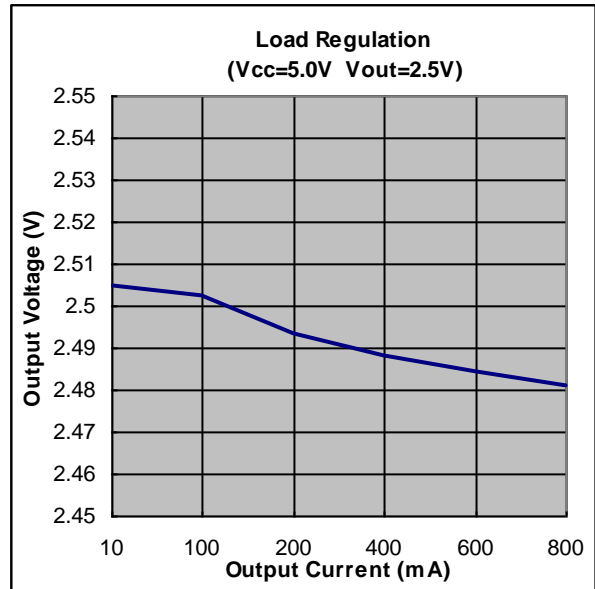

Figure 6

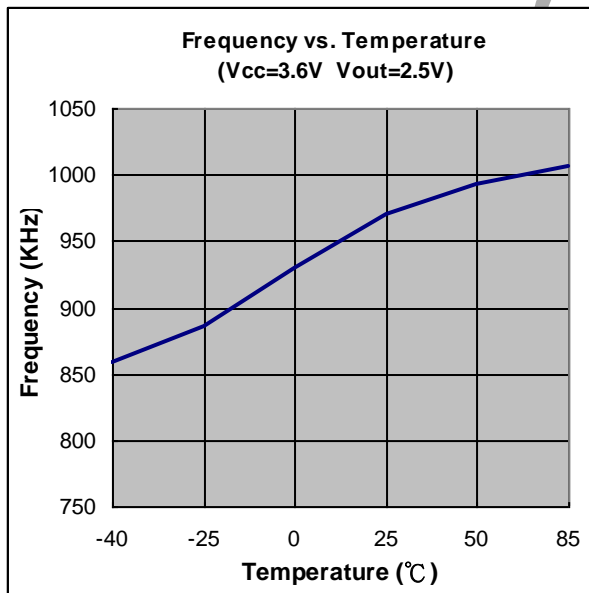

Figure 7

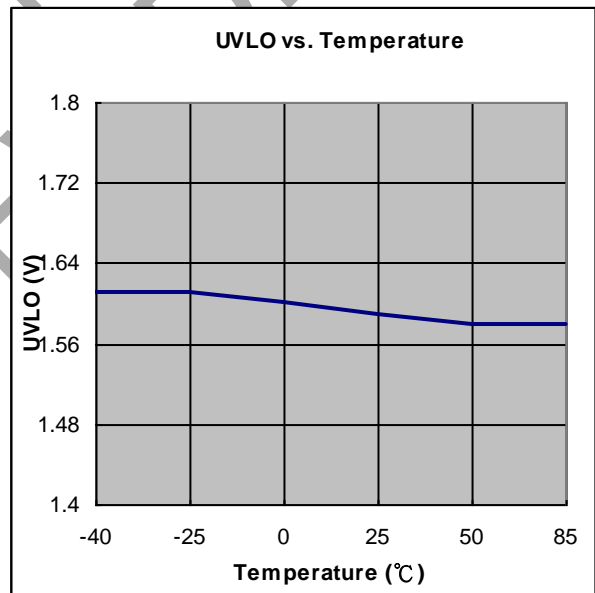

Figure 8



**Typical Operating Characteristics (Continued)**

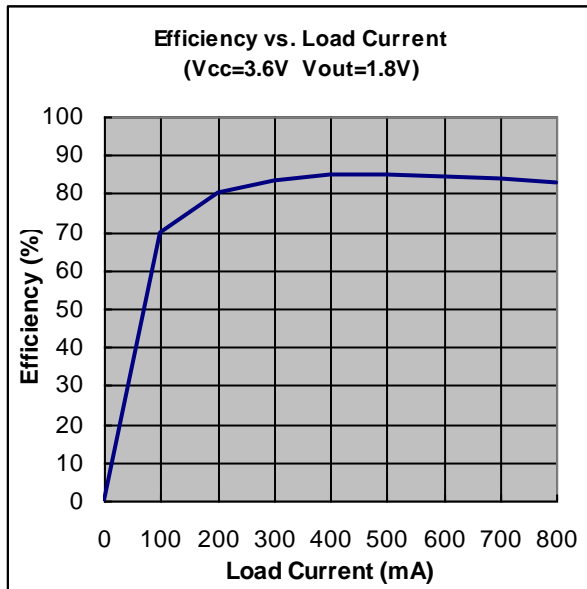

Figure 9

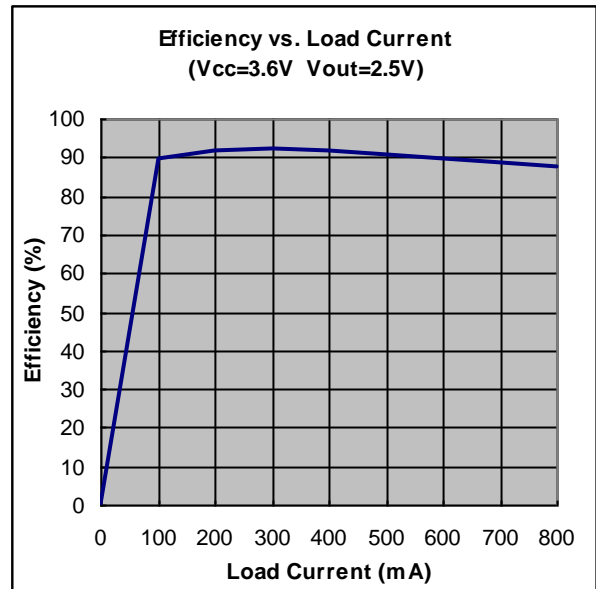

Figure 10

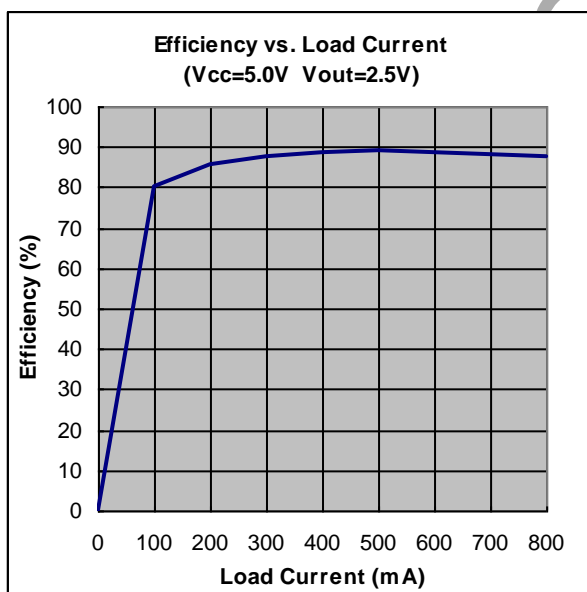

Figure 11

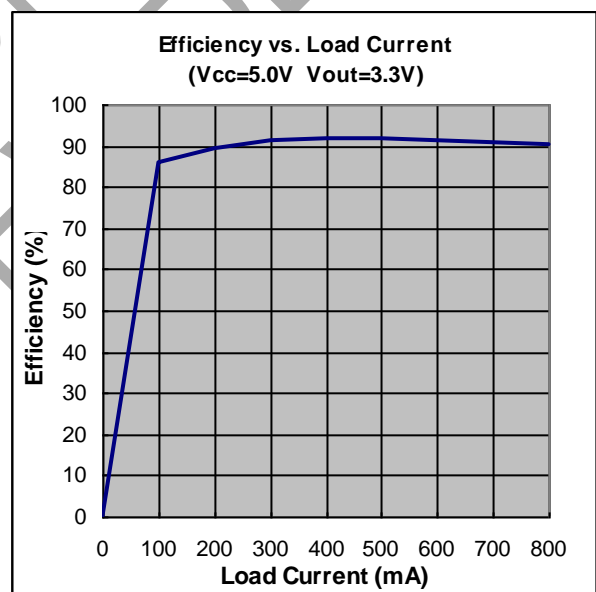

Figure 12

**Typical Operating Characteristics (Continued)**

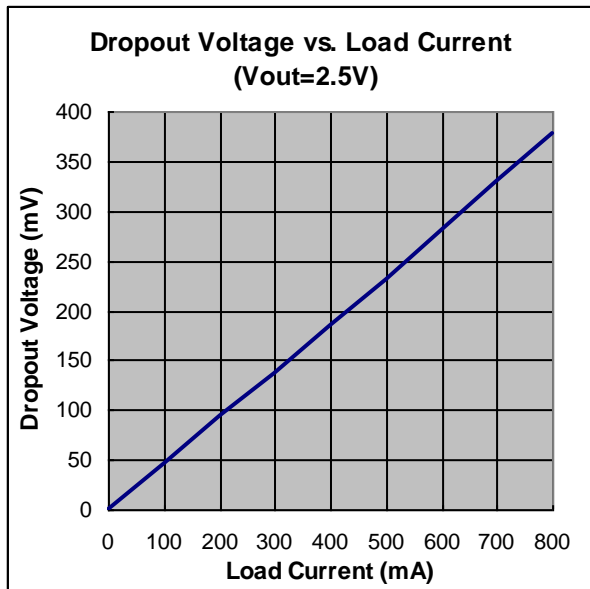

Figure 13

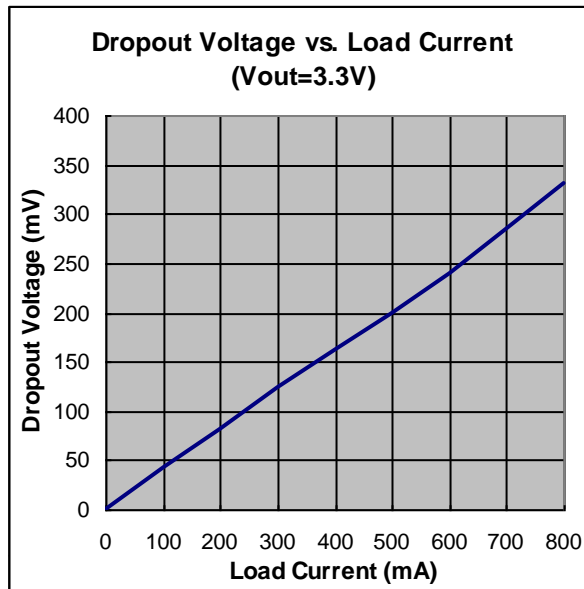

Figure 14

**Output Ripple**

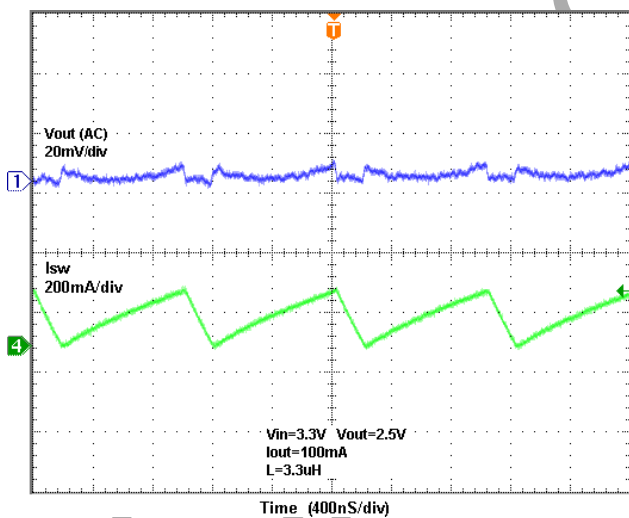

Figure 15

**Output Ripple**

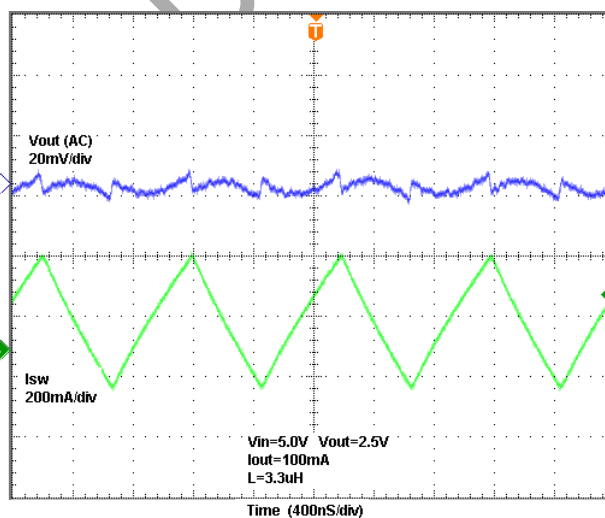

Figure 16

**Typical Operating Characteristics (Continued)**

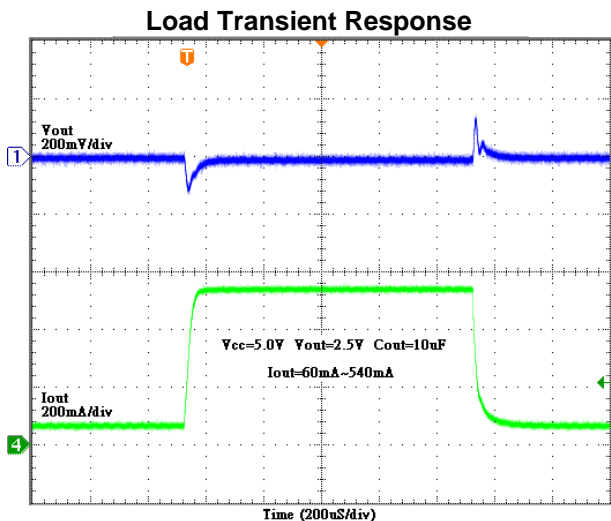

Figure 17

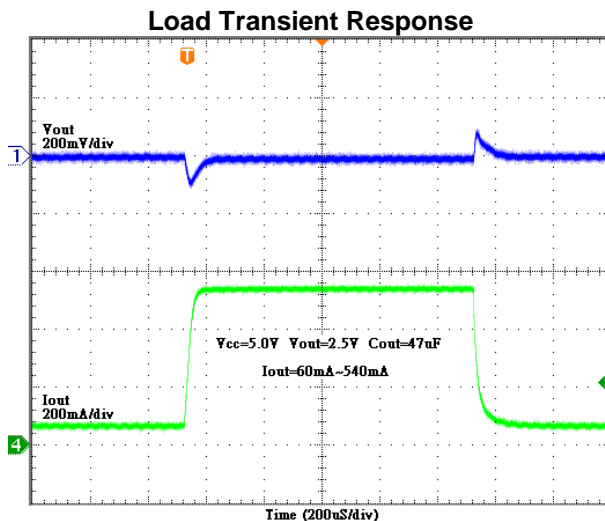

Figure 18

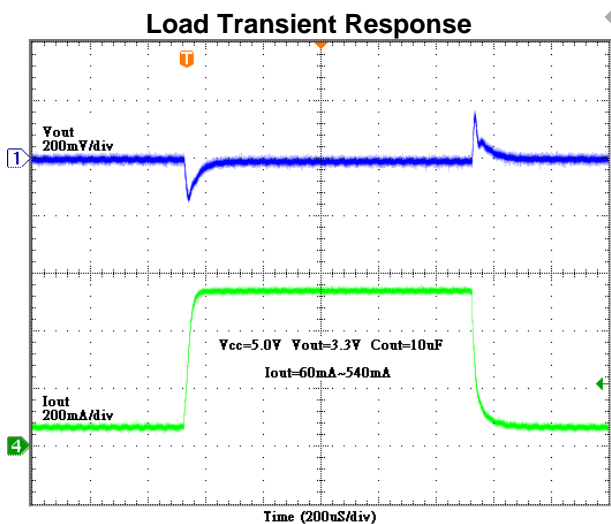

Figure 19

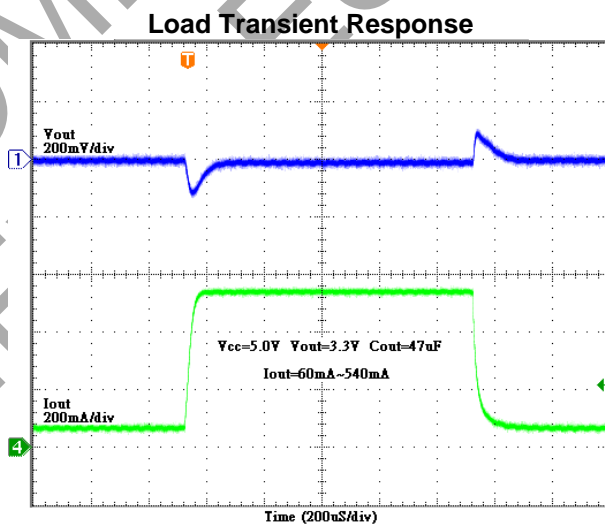

Figure 20

## Application Information

### ■ Enable (EN)

When EN is on logic low, the AP6015 goes into shutdown mode. In shutdown, all other functions are turned off. The supply current is reduced to 1uA (Typ.).

### ■ Soft Start

As the enable pin goes high, the soft-start function generates an internal voltage ramp. This causes the start-up current to slowly raise preventing output voltage overshoot and high inrush currents. The soft-start duration is typical 1mSec.

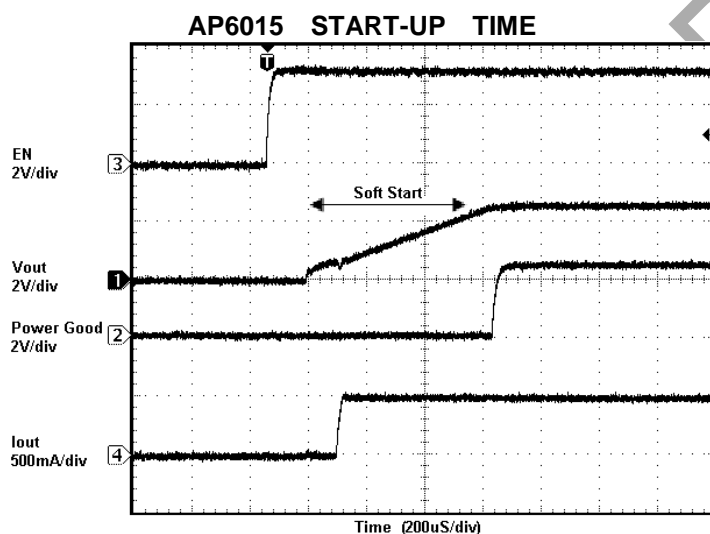

### ■ Under Voltage Lock Out (UVLO)

The UVLO prevents the converter from turning on when the voltage on  $V_{CC}$  is less than typically 1.6V.

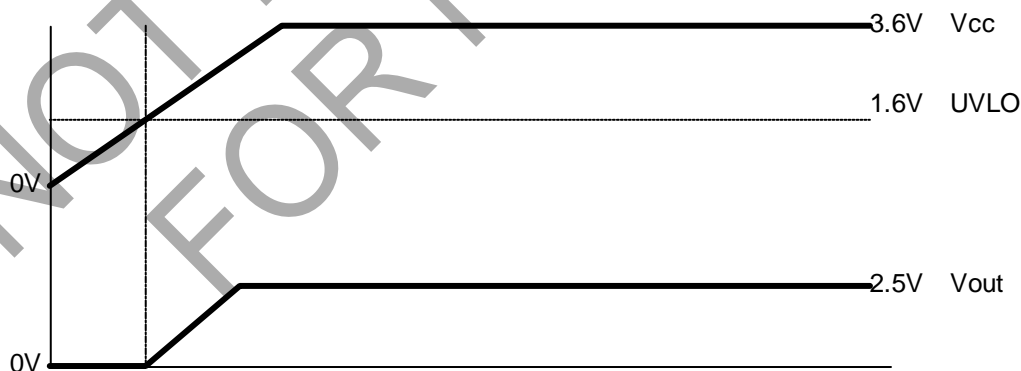

**Application Information (Continued)**

■ **Power Good (PG)**

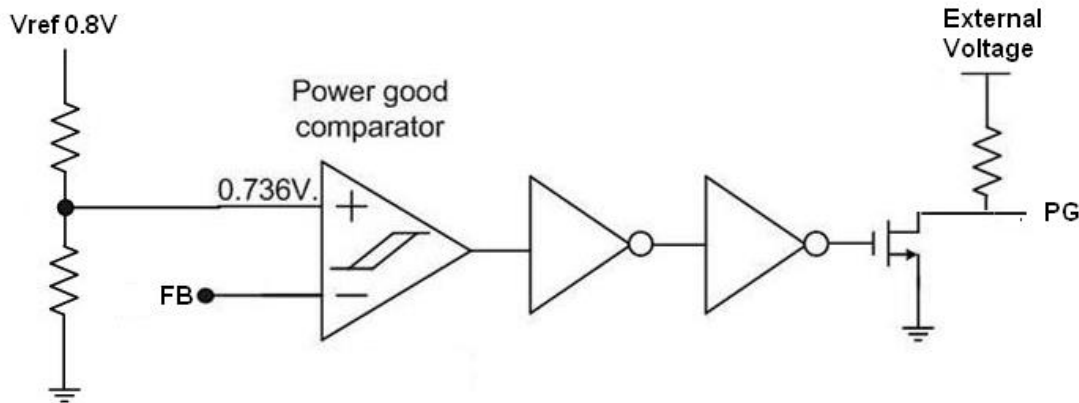

The PG comparator has an open drain output capable of sinking typically 10mA. The PG is only active when the AP6015 is enable (EN=high). When the AP6015 is disable (EN=low), the PG pin is high impedance. If the PG pin is connected to the output of the AP6015 with a pull-up resistor, no initial spike occurs and precautions have to be taken during start-up. The PG pin becomes active high when the output voltage exceeds typically 92% of its nominal value. Leave the PG pin unconnected when not used.

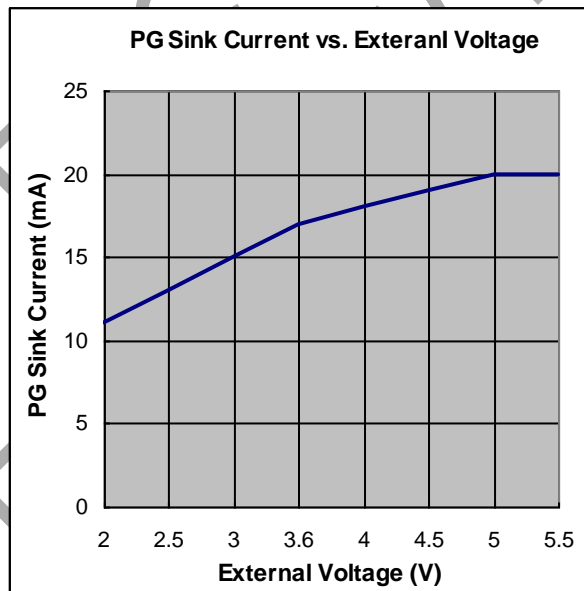

**Application Information (Continued)**

■ **Inductor Selection**

In order to avoid saturation of the inductor, the inductor should be rated at least for the maximum output current plus the inductor ripple current which is calculated as:

$$\Delta I_L = V_O \times \frac{1 - \left(\frac{V_O}{V_{CC}}\right)}{L \times f} \quad I_{L(MAX)} = I_{O(MAX)} + \frac{\Delta I_L}{2}$$

Where:

f= Switching frequency (1MHz typical)

L = Inductor value

$\Delta I_L$  = Peak-to-peak inductor ripple current

$I_L(max)$  = Maximum inductor current

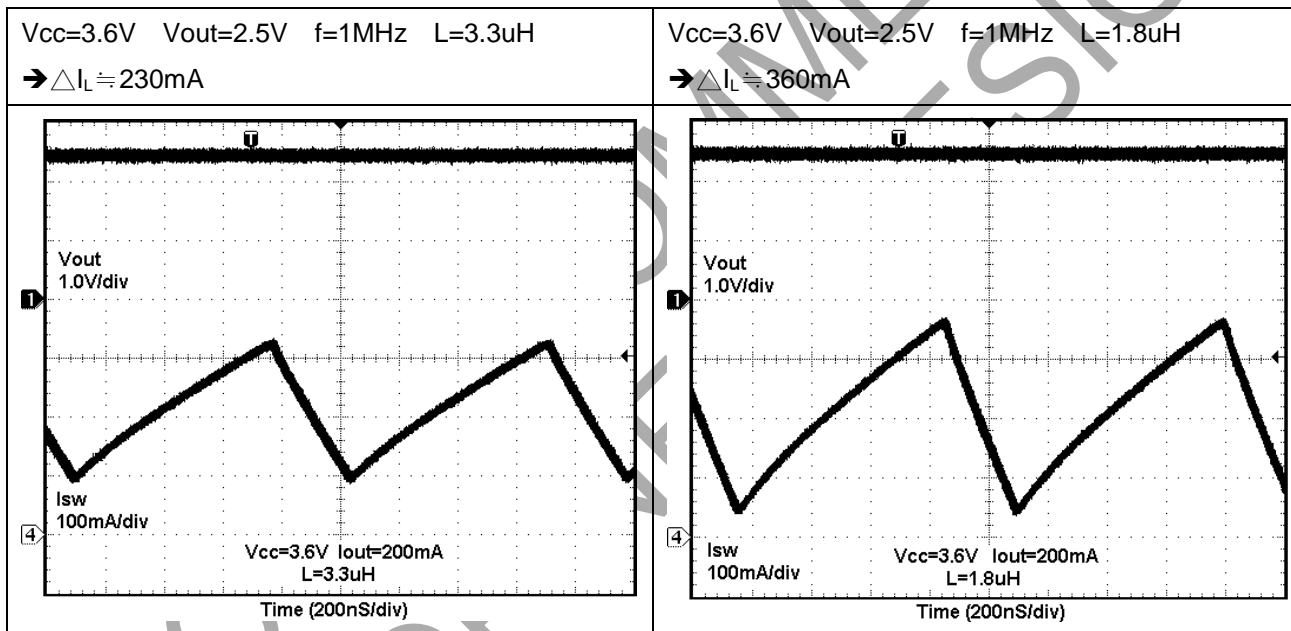

### Application Information (Continued)

#### ■ Input Capacitor Selection

Though there is no special requirement for the ESR (Equivalent Series Resistance) of the input capacitor, due attention should be paid to the tolerance and temperature coefficient of the capacitor used. A 10uF or larger capacitance is required between the PVCC and the GND pins. The input capacitor should be placed as close as possible to the PVCC pin in order to achieve good overall system performance.

#### ■ Output Capacitor Selection

Ripple at the voltage output pin is caused by the charge-and-discharge of the output capacitor. For the best performance, a low ESR output capacitor should be used. The equation below demonstrates how the size of the ripple can be calculated.

$$\Delta V_o = V_o \times \frac{1 - \left(\frac{V_o}{V_{cc}}\right)}{L \times f} \times \left(\frac{1}{8 \times C_o \times f} + ESR\right) = \Delta I_L \times \left(\frac{1}{8 \times C_o \times f} + ESR\right)$$

Where:

$\Delta V_o$  = Output voltage ripple

L = Inductor value

f = Switching frequency (1MHz typical)

$\Delta I_L$  = Peak-to-peak inductor ripple current

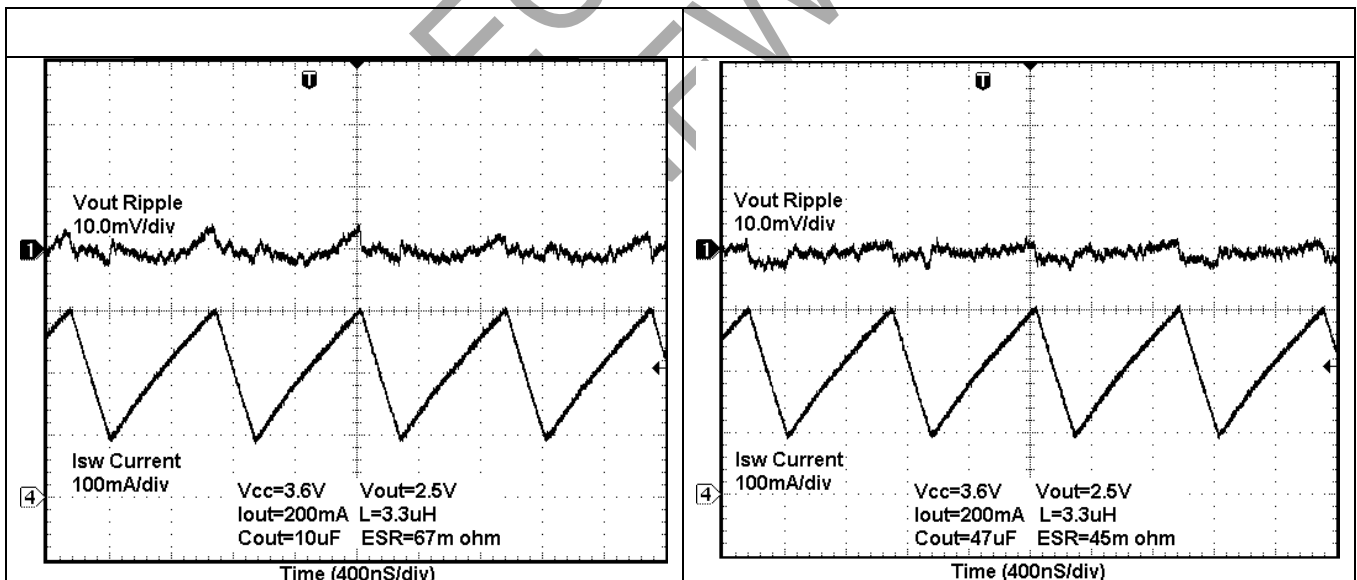

**Application Information (Continued)**

■ **Layout Considerations**

A good board layout practice can significantly improve the stability of the application circuit and reduce the system noise. The feedback path must be as short as possible. The input capacitor and bypass capacitor must be placed close to the PVCC and the VCC pins for optimal performance. It is recommended that the ground planes for System Ground / Power Ground / Analog Ground are isolated from each others, while they should all be joined together at a common point. An example drawing of a circuit with good ground noise performance is shown below.

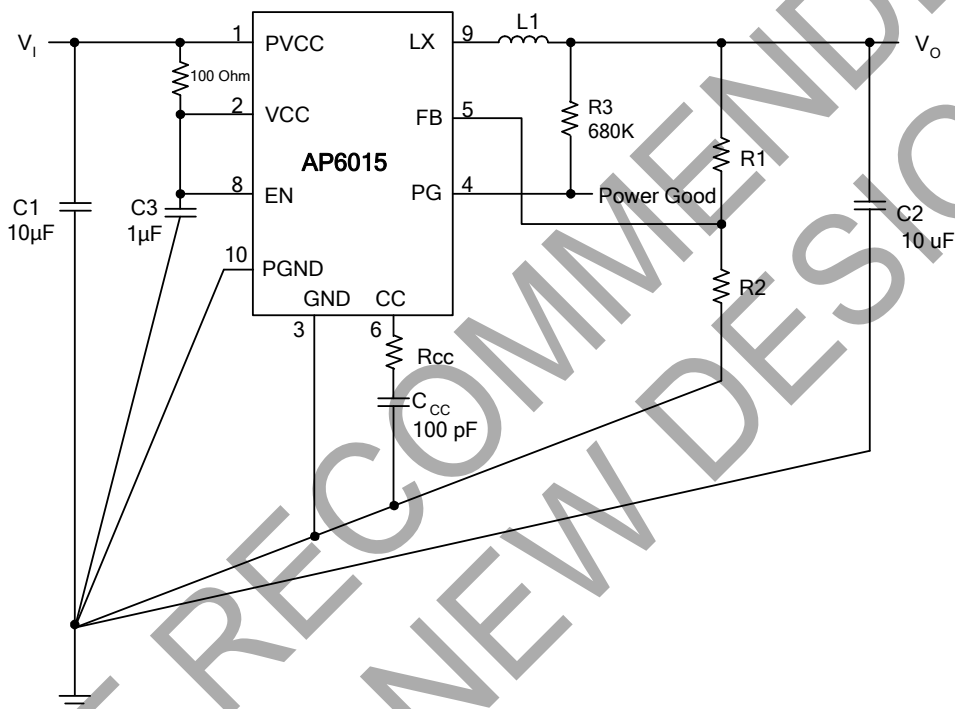

The external inductor must be placed as close as possible to the switching node, i.e. the LX pin. The copper traces on the pcb, where high peak switching current may flow through, should be kept 'wide' and 'short'. This results in low inductance and capacitance in the current path, hence ground shift problem is avoided and system stability stay within bound.



**Marking Information**

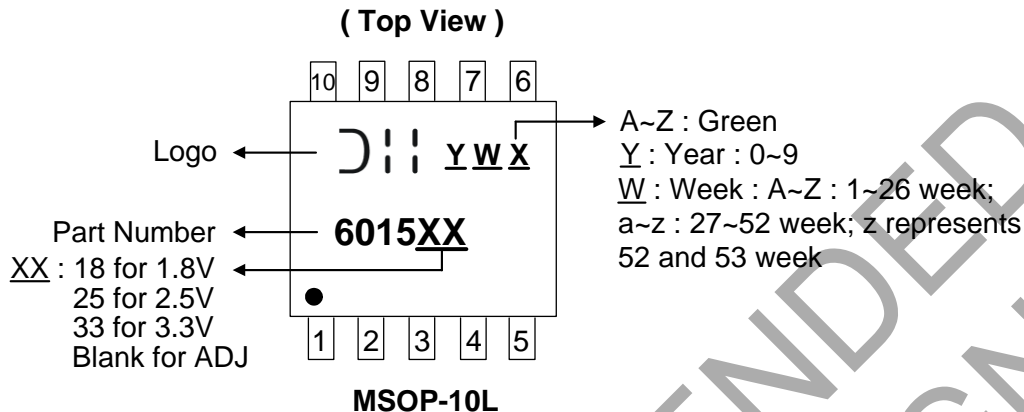

**Package Information (All Dimensions in mm)**

(1) Package type: MSOP-10L

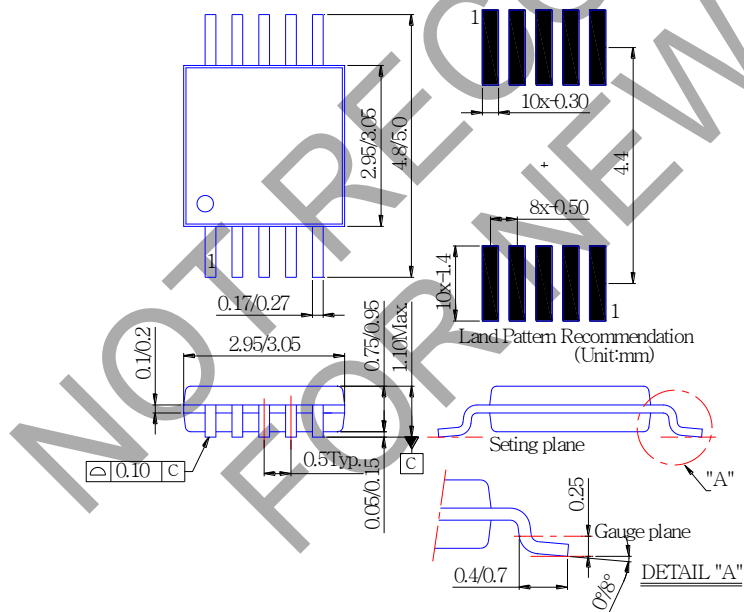

IMPORTANT NOTICE

Diodes Incorporated and its subsidiaries reserve the right to make modifications, enhancements, improvements, corrections or other changes without further notice to any product herein. Diodes Incorporated does not assume any liability arising out of the application or use of any product described herein; neither does it convey any license under its patent rights, nor the rights of others. The user of products in such applications shall assume all risks of such use and will agree to hold Diodes Incorporated and all the companies whose products are represented on our website, harmless against all damages.

LIFE SUPPORT

Diodes Incorporated products are not authorized for use as critical components in life support devices or systems without the expressed written approval of the President of Diodes Incorporated.

NOT RECOMMENDED  
FOR NEW DESIGN

单击下面可查看定价，库存，交付和生命周期等信息

[>>Diodes Incorporated\(达达科技\(美台\)\)](#)