



A Product Line of  
Diodes Incorporated



# SPECIFICATION FOR APPROVAL

CUSTOMER	_____
NOMINAL FREQUENCY	12.288000 MHz
PRODUCT TYPE	TYPE HX 2.5x2.0 SEAM SEALED CRYSTAL CLOCK OSCILLATOR
SPEC. NO. ( P/N )	HX2112201Q
CUSTOMER P/N	_____
ISSUE DATE	May 28, 2018
VERSION	B

APPROVED	PREPARED	QA
<i>Brenda Kuo</i>	<i>Sylvia Yang</i>	<i>Dony Yang</i>

## Diodes Incorporated

No.2, Ziqiang 5th Rd., Zhongli Industrial Park,  
 Zhongli Dist., Taoyuan City 32063, Taiwan (R.O.C.)  
 TEL: 886-3-451-8888  
 FAX: 886-3-461-3865  
<https://www.diodes.com>

- \*Pb-free
- \*RoHS Compliant
- \*HF-Halogen Free
- \*REACH Compliant
- \*AEC-Q200 Compliant



# TYPE HX 2.5x2.0 SEAM SEALED CRYSTAL CLOCK OSCILLATOR

## HX2112201Q

VER. B 28-May-18

### ELECTRICAL SPECIFICATIONS

SRe Part Number : HX2112201Q

Item	Symbol	Specifications	Units	Notes
Nominal Frequency	F <sub>o</sub>	12.288000	MHz	
Frequency Stability	FT	± 40	ppm	**See note
Operating Temperature Range	TR	-40 to +95	°C	
Supply Voltage	V <sub>DD</sub>	+3.3 ± 5%	V	
Logic Type	LT	LVC MOS		
Supply Current, Output Enabled	I <sub>DD</sub> /OE	20	mA	Max
Supply Current, Output Disabled	I <sub>DD</sub> /OD	100	µA	Max
Duty Cycle (Symmetry)	DC/SY	45 / 55	%	Measured 50% of Waveform
Rise / Fall Time	T <sub>R</sub> /T <sub>F</sub>	8	ns	Max. measured 20 / 80% of Waveform
Output Voltage "0" Level	V <sub>OL</sub>	10% V <sub>DD</sub>	V	Max
Output Voltage "1" Level	V <sub>OH</sub>	90% V <sub>DD</sub>	V	Min
Output Load	CL	15	pF	Max
Jitter, Phase	RMS	1	ps	Max. 12KHz ~ 5MHz Frequency Band
Jitter, Accumulated	RMS(1-σ)	4	ps	Max. 20,000 Consecutive Periods
Jitter, Peak to Peak	PK-PK	40	ps	Max. 100,000 Random Periods
Start Up Time		10	ms	Max.
Storage Temperature Range		-55 to +125	°C	

※ This product doesn't include harmful substance that stipulated by SONY SS-00259 Level 1 and S-AT2-001 Level 1 standard. RoHS Compliant (Pb - Free).

\*\*Stability includes all combinations of Operating Temperature, Load changes, rated Input (Supply) Voltage changes, Initial Calibration Tolerance (25°C), Aging (1 year at 25°C Average Effective Ambient Temperature), Shock and Vibration.

#### Output Enable / Disable Function

Parameter	Min.	Typ.	Max.	Units	Notes
Input Voltage (Pin1), Output Enable	0.7V <sub>DD</sub>			V	Or Open
Input Voltage (Pin1), Output Disable (low power standby)			0.3V <sub>DD</sub>	V	Output is Hi-Z
Internal Pullup Resistance	30			KΩ	
Output Disable Delay			50	ns	



# TYPE HX 2.5x2.0 SEAM SEALED CRYSTAL CLOCK OSCILLATOR

## HX2112201Q

VER. B 28-May-18

### TEST CIRCUIT

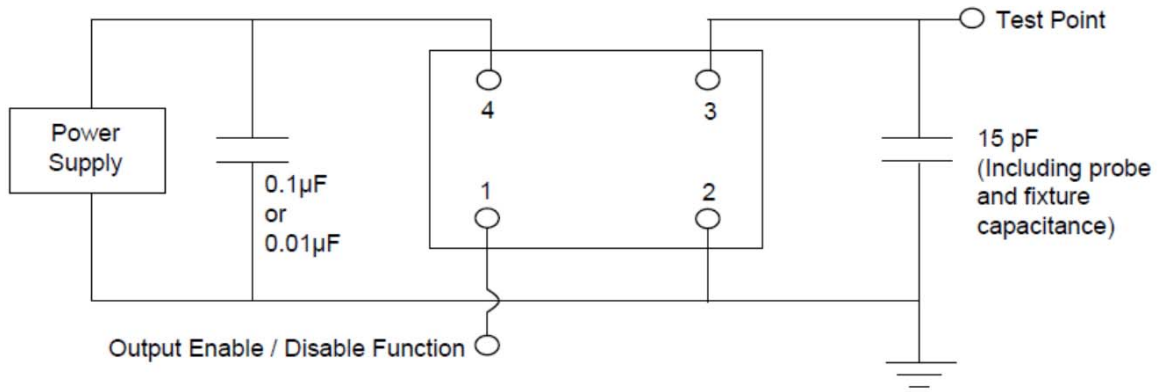

### OUTPUT WAVEFORM

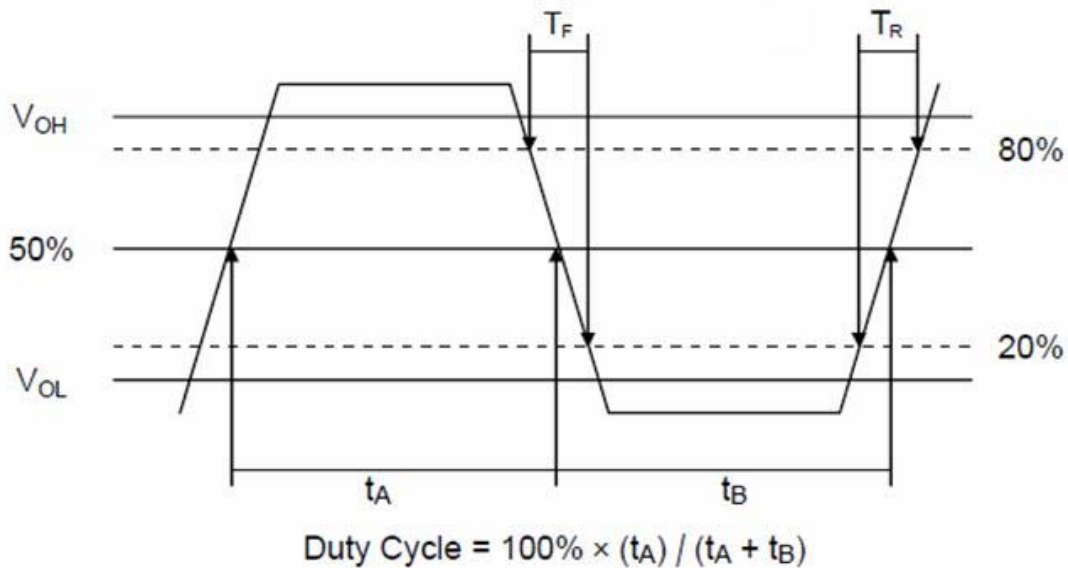

# TYPE HX 2.5x2.0 SEAM SEALED CRYSTAL CLOCK OSCILLATOR

**HX2112201Q**

VER. B 28-May-18

## AEC-Q200 RELIABILITY TEST SPECIFICATIONS:

### 1. Initial

- 1.1 Physical Dimensions: JESD22, Method JB1-100
- 1.2 External Visual: MIL-STD-883, Method 2009
- 1.3 Freq. Vs. Temperature: Per Specification/Datasheet

### 2. Mechanical

- 2.1 Mechanical Shock: MIL-STD-202 Method 213
- 2.2 Vibration: MIL-STD-202 Method 204
- 2.3 Solderability: J-STD-002
- 2.4 Board Flex: AEC Q200-005
- 2.5 Terminal Strength (SMD): AEC Q200-006

### 3.Environmental

- 3.1 Temp Cycle: JESD22, Method JA-104
- 3.2 Resistance to Solder Heat: MIL-STD-202 Method 210
- 3.3 High Temperature Operating Life: MIL-STD-202, Method 108
- 3.4 High Temp Exposure: MIL-STD-202, Method 108
- 3.5 High Temp & High Humidity: MIL-STD-202, Method 103
- 3.6 Thermal Shock: MIL-STD-202, Method 107

## SUGGESTED IR REFLOW PROFILE

\*As per IPC-JEDEC J-STD-020D

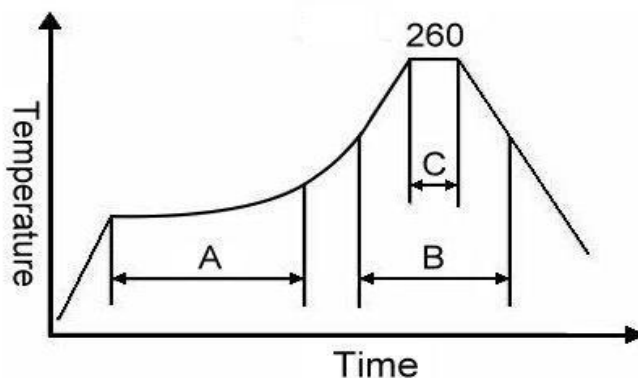

Note:

	Stage	Temperature	Time
A	Preheat	150~200°C	60~120 Sec
B	Primary Heat	217°C	60~150 Sec
C	Peak	260°C	10 Sec

# TYPE HX 2.5x2.0 SEAM SEALED CRYSTAL CLOCK OSCILLATOR

## HX2112201Q

VER. B 28-May-18

### MARKING

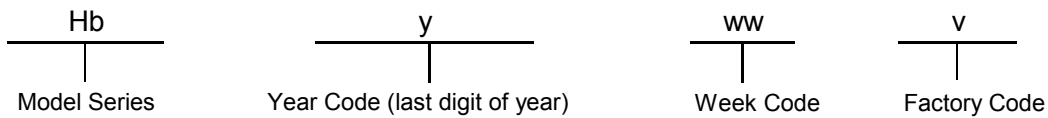
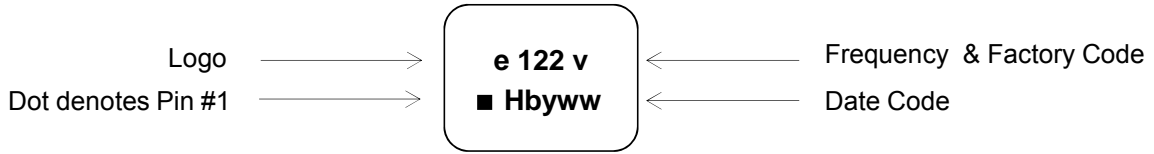

### MECHANICAL DRAWINGS ( Scale:None. Dimensions are in mm.)

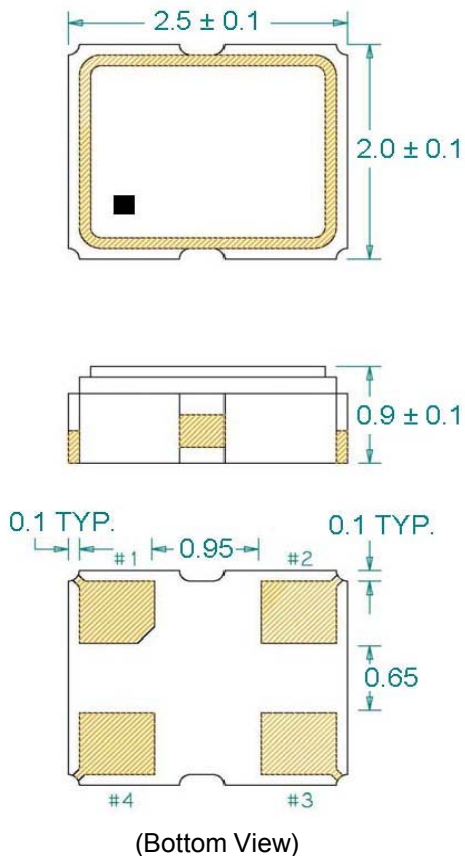

#### Recommended Land Pattern\*

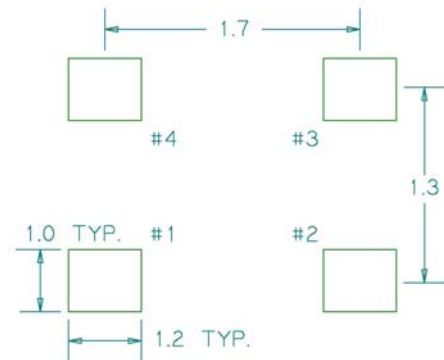

\*External high-frequency power decoupling is recommended. (see test circuit for minimum recommendation). To ensure optimal performance, do not route traces beneath the package.

Pin	Function
1	OE
2	Ground
3	Clock Output
4	$V_{DD}$



# TYPE HX 2.5x2.0 SEAM SEALED CRYSTAL CLOCK OSCILLATOR

## HX2112201Q

VER. B 28-May-18

### PACKING

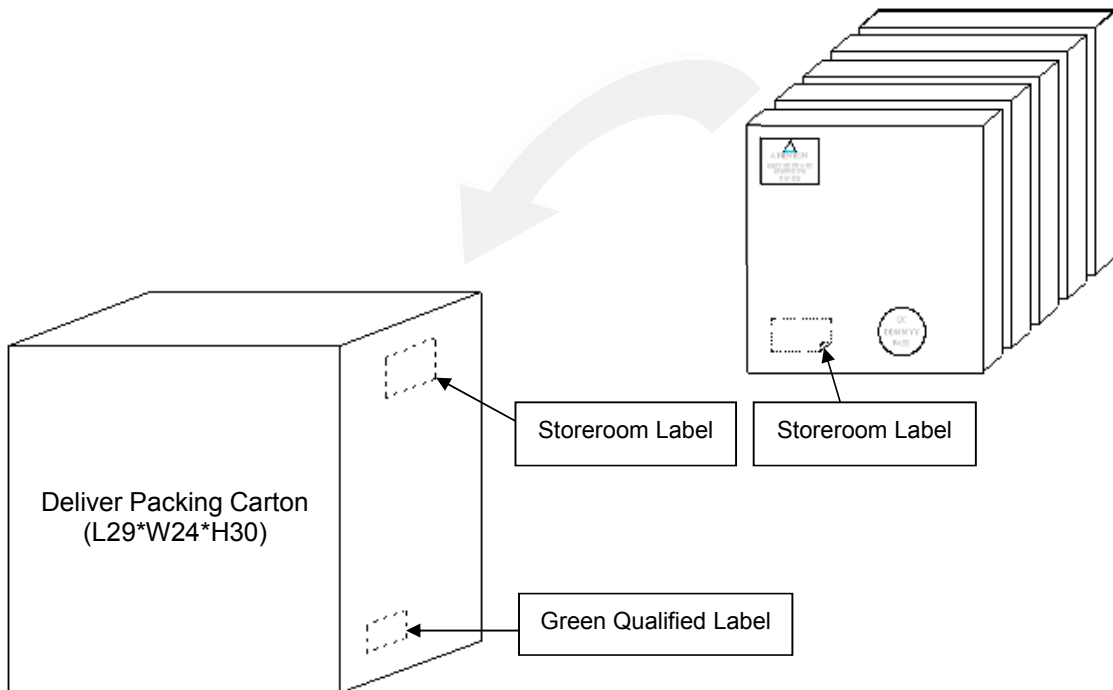
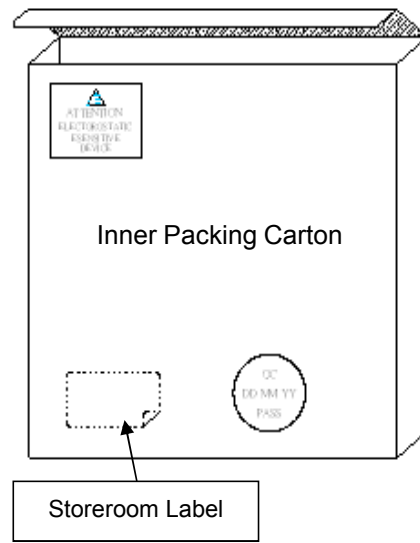
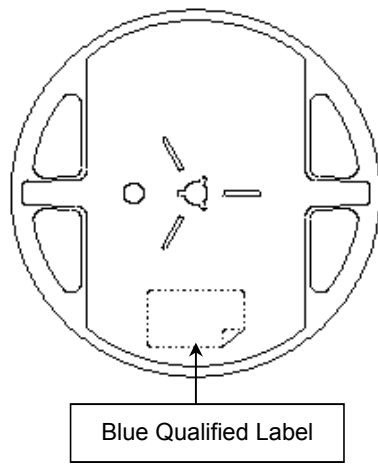
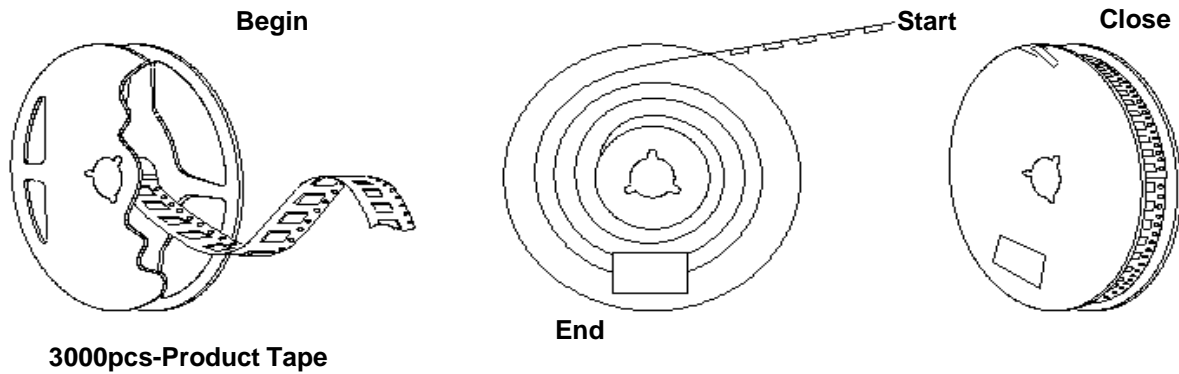



单击下面可查看定价，库存，交付和生命周期等信息

[>>Diodes Incorporated\(达达科技\(美台\)\)](#)