

Description

The AP7340 is a low dropout regulator with high output voltage accuracy, low $R_{DS(on)}$, high PSRR, low output noise and low quiescent current. This regulator is based on a CMOS process.

The AP7340 includes a voltage reference, error amplifier, current limit circuit and an enable input to turn it on and off. With the integrated resistor network, fixed output voltage versions can be delivered.

With its low power consumption and line and load transient response, the AP7340 is well suited for low power handheld communication equipment.

The AP7340 is packaged in an X2-DFN1010-4 package and allows for smallest footprint and dense PCB layout.

Features

- Low V_{IN} and wide V_{IN} Range: 1.7V to 5.25V
- Guarantee Output Current, 150mA
- V_{OUT} accuracy $\pm 1\%$
- Ripple Rejection 75dB at 1kHz
- Low Output Noise, 60uVrms from 10Hz to 100kHz
- Quiescent Current as low as 35 μ A
- V_{OUT} fixed 1.1V to 3.3V
- **Totally Lead-Free & and Fully RoHS Compliant (Notes 1 & 2)**
- **Halogen and Antimony Free, Green Device (Note 3)**

- Notes:
1. No purposely added lead. Fully EU Directive 2002/95/EC (RoHS) & 2011/65/EU (RoHS 2) compliant.
 2. See http://www.diodes.com/quality/lead_free.html for more information about Diodes Incorporated's definitions of Halogen- and Antimony-free, "Green" and Lead-free.
 3. Halogen- and Antimony-free "Green" products are defined as those which contain <900ppm bromine, <900ppm chlorine (<1500ppm total Br + Cl) and <1000ppm antimony compounds.

Pin Assignments

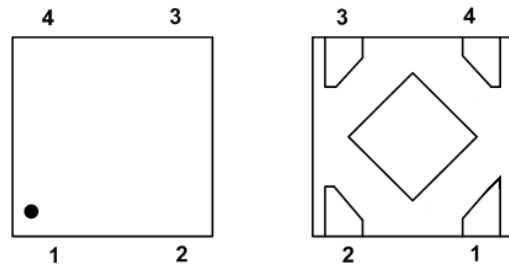

Top View X2-DFN1010-4 Bottom View

PIN1 – V_{OUT} , PIN2 – GND, PIN3 – EN, PIN4 – V_{IN}

Applications

- Smart Phone/PAD
- RF Supply
- Cameras
- Portable Video
- Portable Media Player
- Wireless Adapter
- Wireless Communication

Typical Applications Circuit

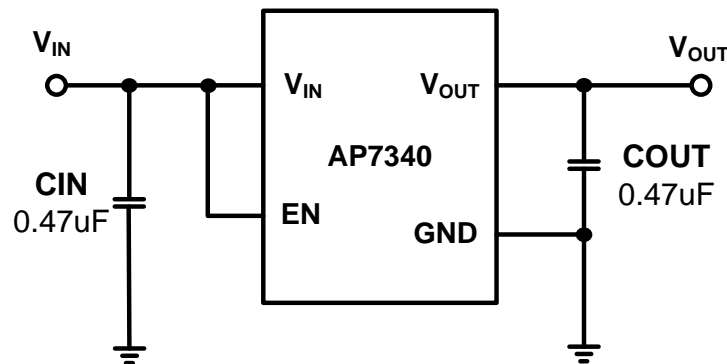
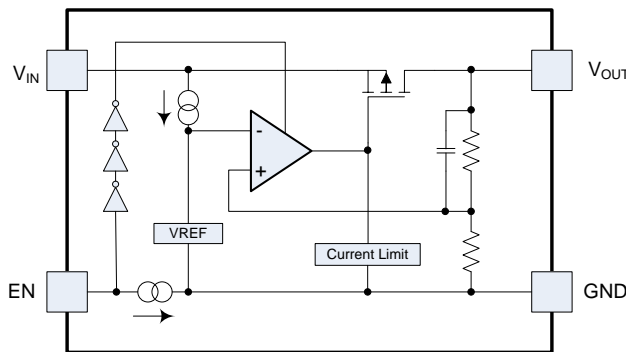

Figure 1 Typical Application Circuit

Pin Descriptions

| Pin Name | PIN No | Function |
|------------------|--------------|--|
| | X2-DFN1010-4 | |
| V _{OUT} | 1 | Power Output Pin |
| GND | 2 | Ground |
| EN | 3 | Enable Pin This pin should be driven either high or low and must not be floating. Driving this pin high enables the regulator, while pulling it low puts the regulator into shutdown mode |
| V _{IN} | 4 | Power Input Pin |
| — | Thermal PAD | In PCB layout, it is preferred to use large copper area to cover this pad for better thermal dissipation, then connect this area to GND or leave it open. However, do not use it as GND electrode function alone |

Functional Block Diagram



AP7340 (non-discharge)

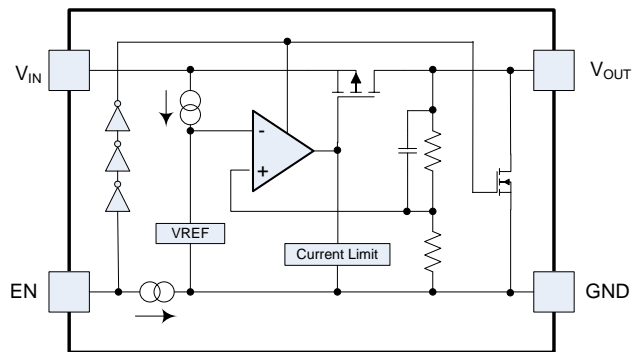

AP7340D (with discharge)

Absolute Maximum Ratings (Note 4) (@T_A = +25°C, unless otherwise specified.)

| Symbol | Parameter | Ratings | Unit |
|------------------|-------------------------------|-------------------------------|------|
| V _{IN} | Input Voltage | 6.0 | V |
| V _{CE} | Input Voltage EN | 6.0 | V |
| V _{OUT} | Output Voltage | -0.3 to V _{IN} + 0.3 | V |
| I _{OUT} | Output Current | 300 | mA |
| P _D | Power Dissipation | 400 | mW |
| T _A | Operating Ambient Temperature | -40 to +85 | °C |
| T _{STG} | Storage Temperature | -55 to +125 | °C |

- Note:
- a). Stresses beyond those listed under Absolute Maximum Ratings may cause permanent damage to the device. These are stress ratings only and functional operation of the device at these conditions is not implied. Exposure to absolute-maximum-rated conditions for extended periods may affect device reliability.
 - b). Ratings apply to ambient temperature at +25°C. The JEDEC High-K board design used to derive this data is a 2in. x 2in. multi-layer board with 1oz. internal power and ground planes and 2oz. copper traces on the top and bottom of the board.

Recommended Operating Conditions (@T_A = +25°C, unless otherwise specified.)

| Symbol | Parameter | Min | Max | Unit |
|------------------|-------------------------------|-----|------|------|
| V _{IN} | Input Voltage | 1.7 | 5.25 | V |
| I _{OUT} | Output Current | 0 | 150 | mA |
| T _A | Operating Ambient Temperature | -40 | +85 | °C |

Electrical Characteristics

($V_{EN} = V_{IN} = V_{OUT} + 1.0V$, $C_{IN} = C_{OUT} = 0.47\mu F$, $I_{OUT} = 1.0mA$ @ $T_A = +25^\circ C$, unless otherwise specified.)

| Parameter | Conditions | Min | Typ | Max | Units | |
|---|---|--------------------------------------|------|----------|----------|-----------------|
| Input Voltage | $T_A = -40^\circ C$ to $+85^\circ C$ | 1.7 | — | 5.25 | V | |
| Output Voltage Accuracy (Note 11) | $V_{IN} = (V_{OUT} - Nom + 1.0V)$ to $5.25V$, $I_{OUT} = 1mA$ to $150mA$ | $T_A = +25^\circ C$ | -1 | — | 1 | % |
| | | $T_A = -40^\circ C$ to $+85^\circ C$ | -1.5 | — | +1.5 | |
| Line Regulation ($dV_{OUT}/dV_{IN}/V_{OUT}$) | $V_{IN} = (V_{OUT} - Nom + 1.0V)$ to $5.25V$, $I_{OUT} = 1.0mA$ | — | 0.02 | 0.1 | %/V | |
| Load Regulation ($dV_{OUT}/V_{OUT}/dI_{OUT}$) | $V_{IN} = V_{OUT} - Nom + 1.0V$, $I_{OUT} = 1mA$ to $150mA$ | — | 0.5 | 1.0 | %/A | |
| Quiescent Current (Note 6) | $I_{OUT} = 0mA$ | — | 35 | 50 | μA | |
| | $I_{OUT} = 150mA$ | — | 60 | 100 | | |
| $I_{STANDBY}$ | $V_{EN} = 0V$ (Disabled) | — | 0.01 | 1.0 | μA | |
| Output Current | — | 150 | — | — | mA | |
| Fold-back Short Current (Note 7) | V_{OUT} short to ground | — | 55 | — | mA | |
| PSRR (Note 8) | $V_{IN} = [V_{OUT} + 1V] VDC + 0.2V_{p-pAC}$, $V_{OUT} \geq 1.8V$, $I_{OUT} = 30mA$ | $f = 1kHz$ | — | 75 | — | dB |
| Output Noise Voltage (Note 8) (Note 9) | $BW = 10Hz$ to $100kHz$, $I_{OUT} = 30mA$ | | — | 60 | — | μV_{rms} |
| Dropout Voltage (Note 5) | $I_{OUT} = 150mA$ | $1.1V \leq V_{OUT} < 1.5V$ | — | 0.50 | 0.62 | V |
| | | $1.5V \leq V_{OUT} < 1.7V$ | — | 0.38 | 0.47 | |
| | | $1.7V \leq V_{OUT} < 2.0V$ | — | 0.34 | 0.42 | |
| | | $2.0V \leq V_{OUT} < 2.5V$ | — | 0.28 | 0.36 | |
| | | $2.5V \leq V_{OUT} < 2.8V$ | — | 0.22 | 0.30 | |
| | | $2.8V \leq V_{OUT} \leq 3.3V$ | — | 0.21 | 0.27 | |
| Output Voltage Temperature Coefficient | $I_{OUT} = 30mA$, $T_A = -40^\circ C$ to $+85^\circ C$ | | — | ± 30 | — | ppm/ $^\circ C$ |
| EN Input Low Voltage | — | 0 | — | 0.5 | V | |
| EN Input High Voltage | — | 1.3 | — | 5.25 | V | |
| EN Input Leakage | $V_{EN} = 0$, $V_{IN} = 5.0V$ or $V_{EN} = 5.0V$, $V_{IN} = 0V$ | -1.0 | — | +1.0 | μA | |
| On Resistance of N-channel for Auto-Discharge (Note 10) | $V_{IN} = 4.0V$, $V_{EN} = 0V$ (Disabled) | — | 30 | — | Ω | |

- Notes:
- Dropout voltage is the voltage difference between the input and the output at which the output voltage drops 2% below its nominal value.
 - Quiescent current is defined here as the difference in current between the input and the output.
 - Short circuit current is measured with V_{OUT} pulled to GND.
 - This specification is guaranteed by design.
 - To make sure lowest environment noise minimizes the influence on noise measurement.
 - AP7340 has 2 options for output, built-in discharge and non-discharge.
 - Potential multiple grades based on following output voltage accuracy.

Typical Characteristics

Output Voltage vs. Output Current
AP7340-18

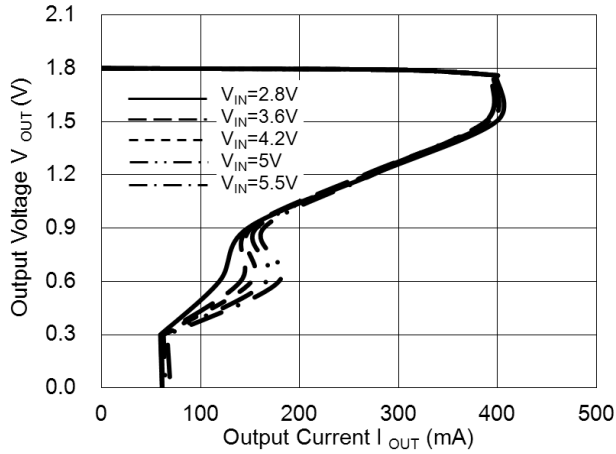

Output Voltage vs. Output Current
AP7340-25

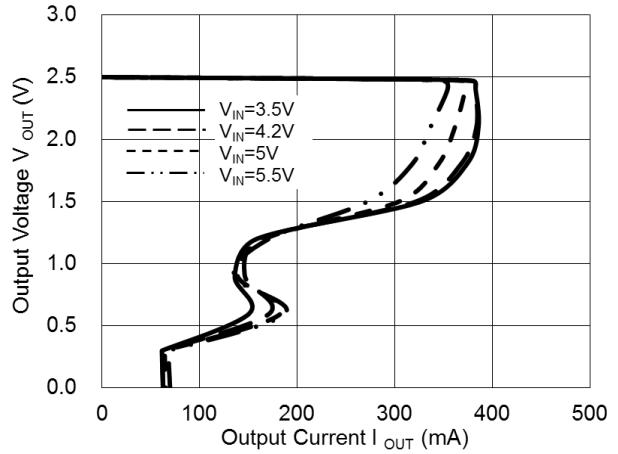

Output Voltage vs. Output Current
AP7340-33

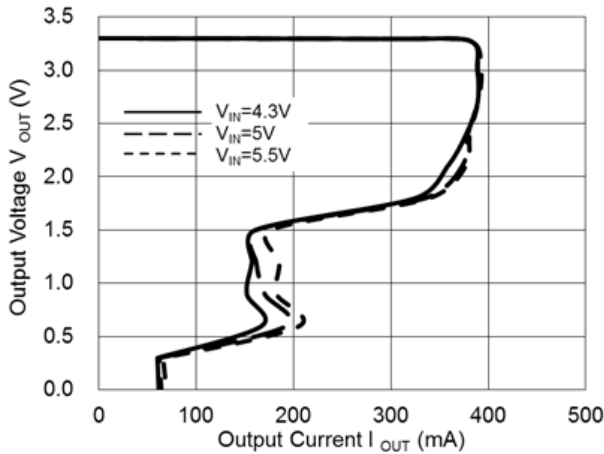

Output Noise (AP7340-33)

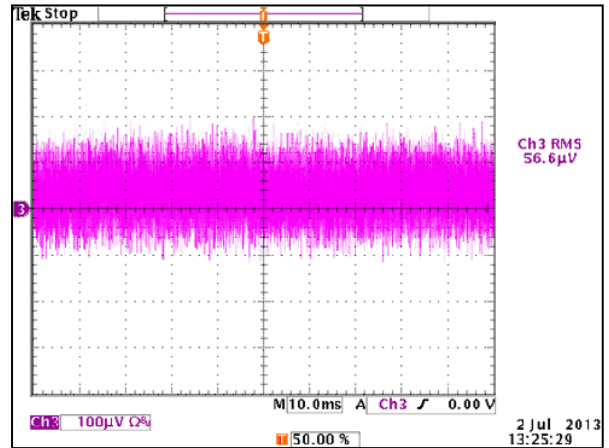

Output Voltage vs. Input Voltage
AP7340-25

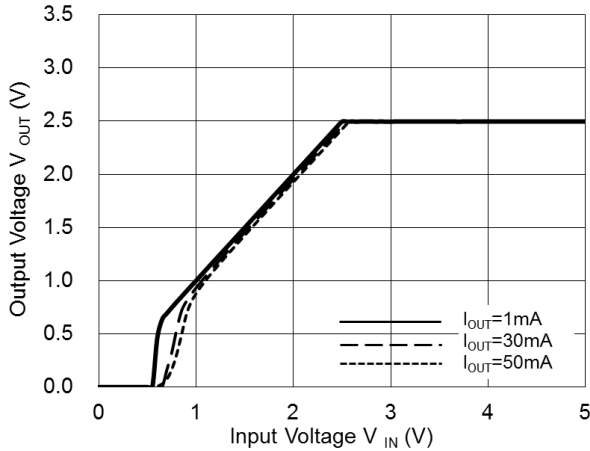

Output Voltage vs. Input Voltage
AP7340-33

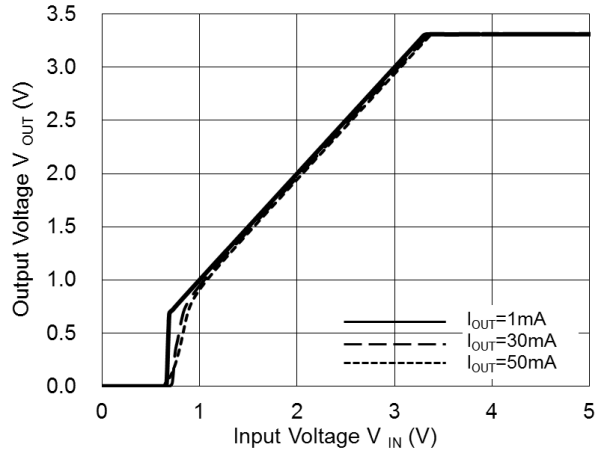

Typical Characteristics (cont.)

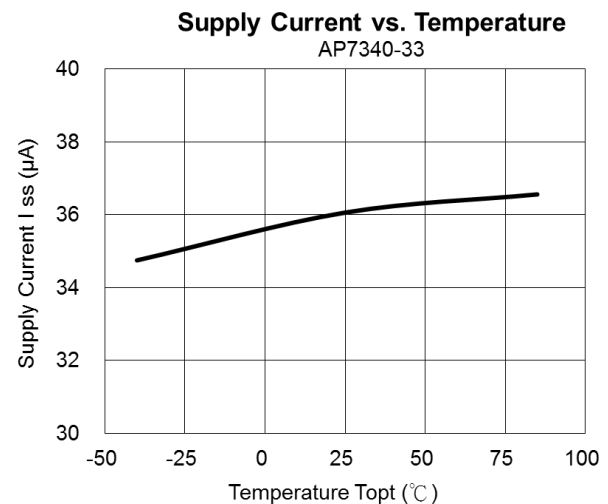
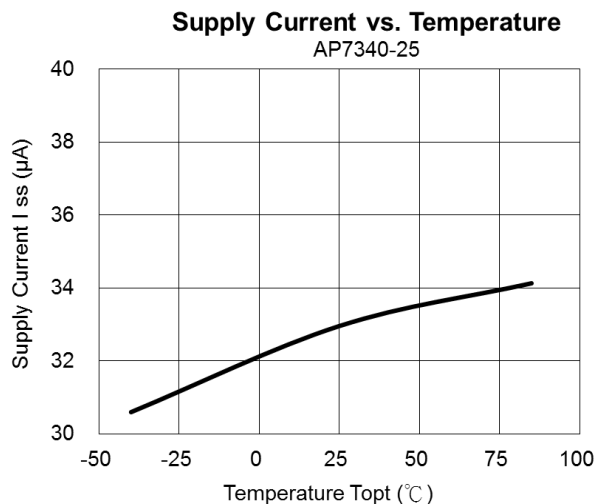
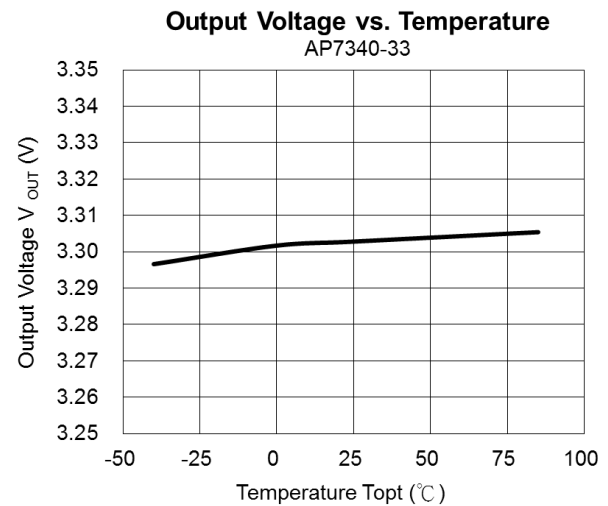
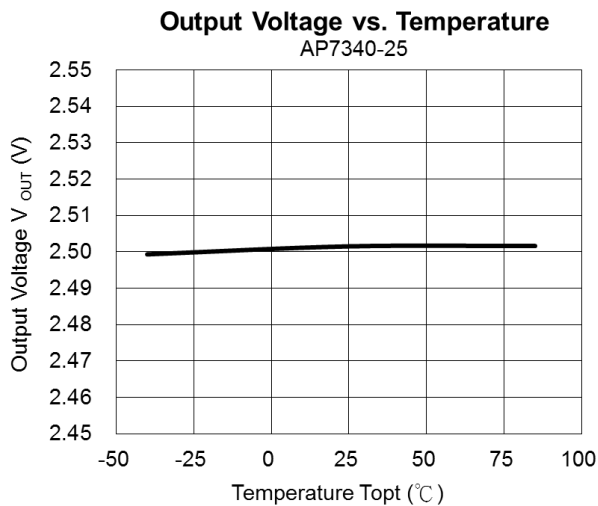
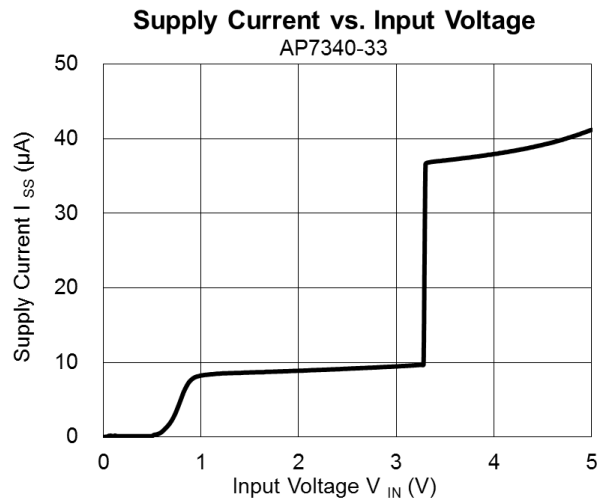
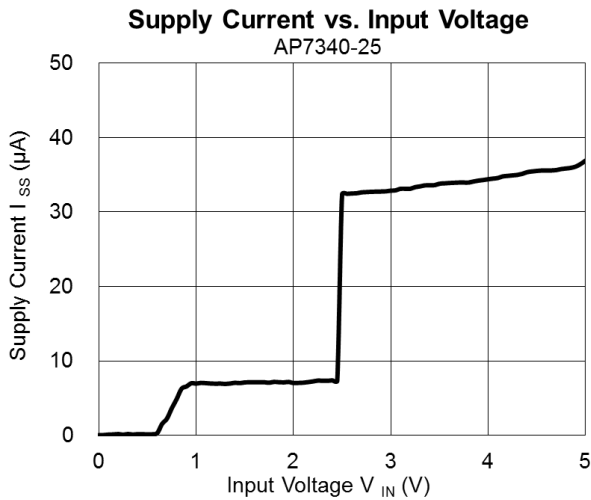

Typical Characteristics (cont.)

Dropout Voltage vs. Output Current
AP7340-25

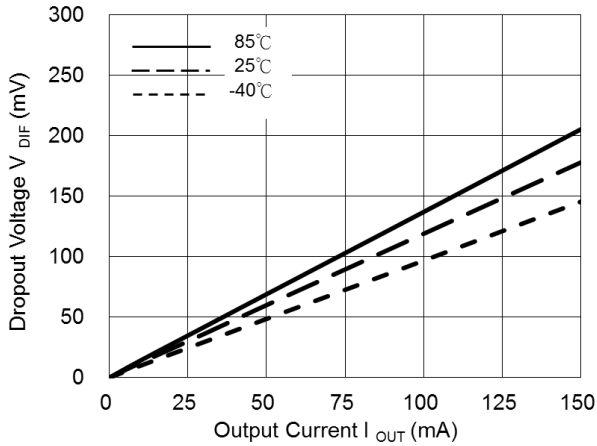

Dropout Voltage vs. Output Current
AP7340-33

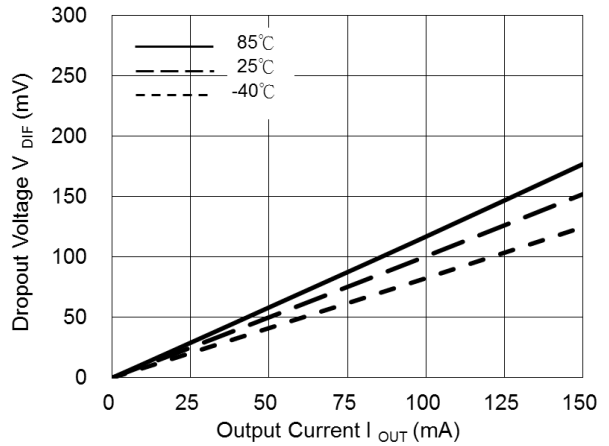

Dropout Voltage vs. Temperature
AP7340-25

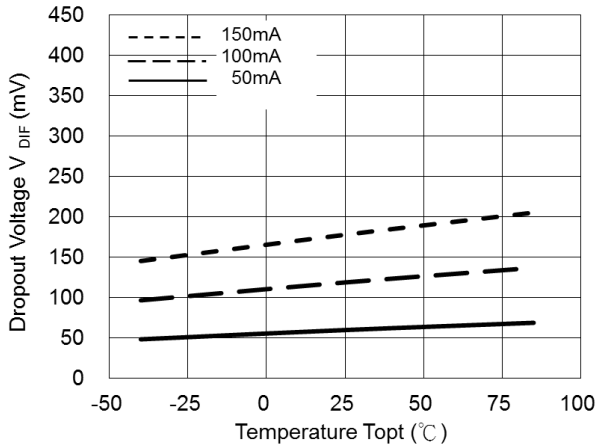

Dropout Voltage vs. Temperature
AP7340-33

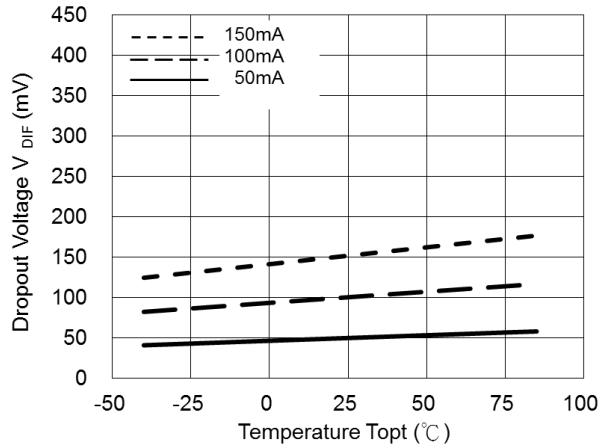

Dropout Voltage vs. Set Output Voltage

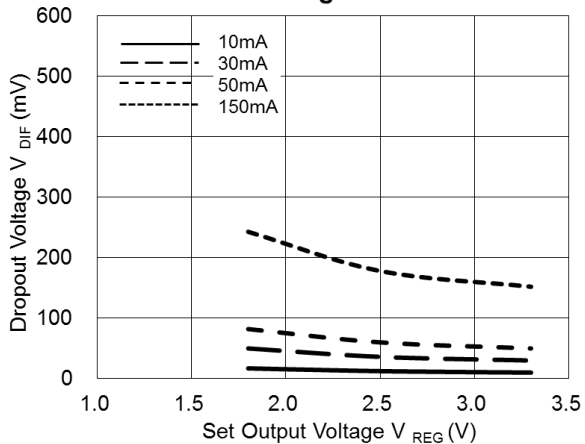

Typical Characteristics (cont.)

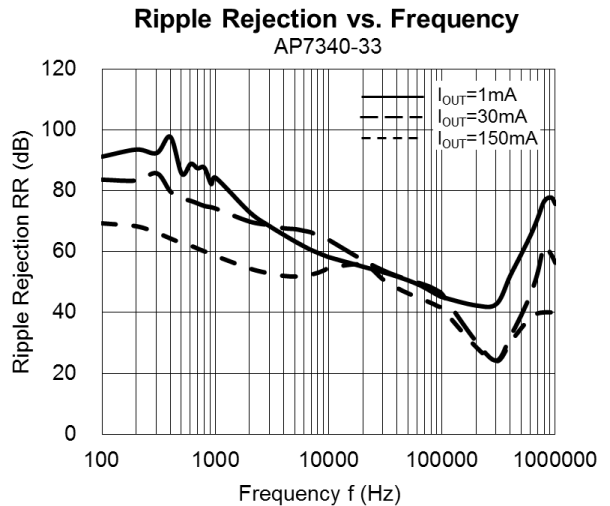
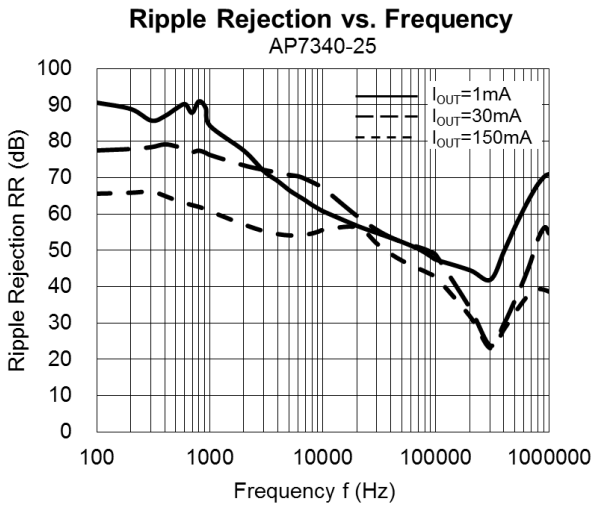
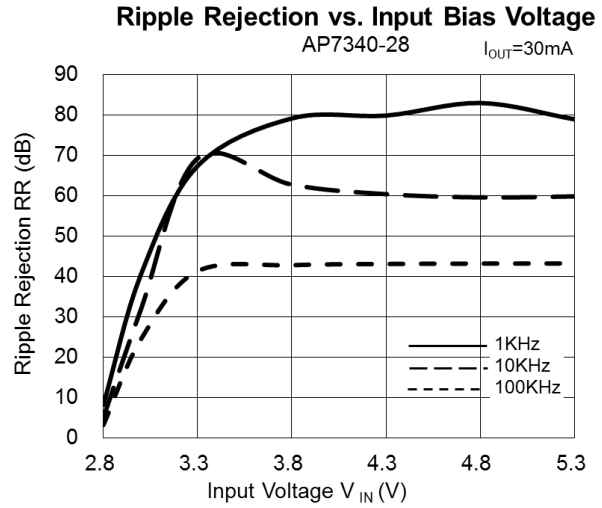
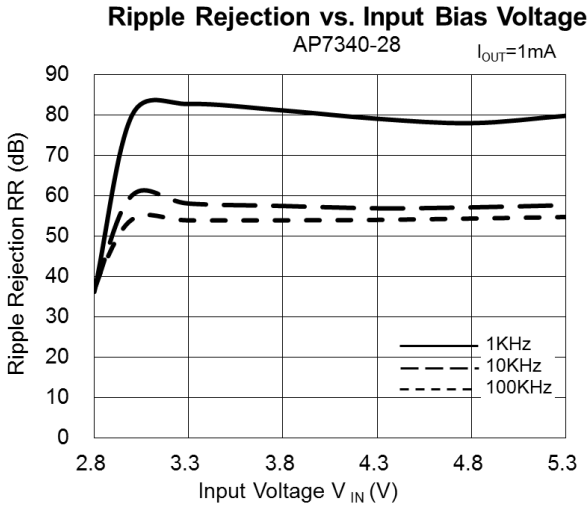

Typical Characteristics (cont.)

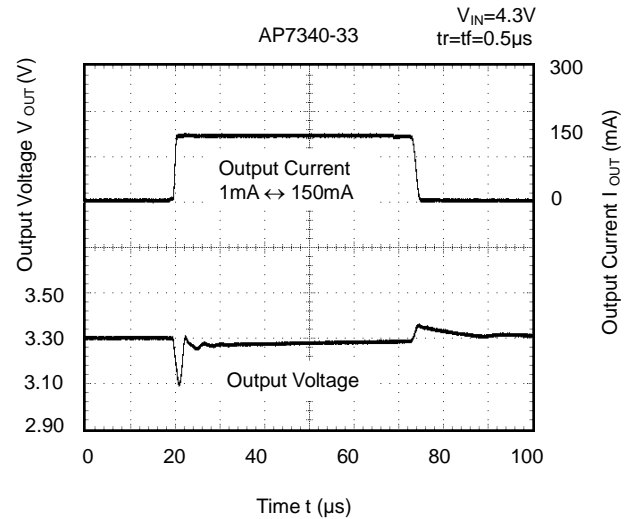
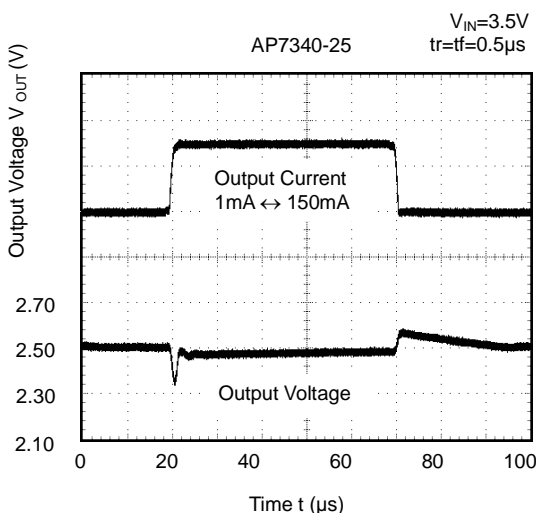
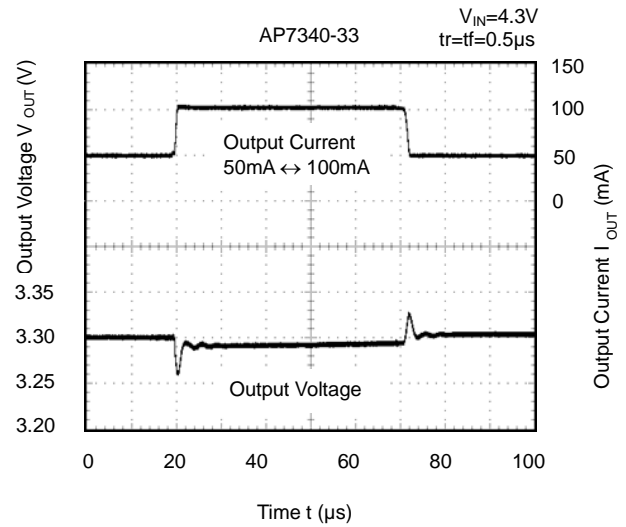
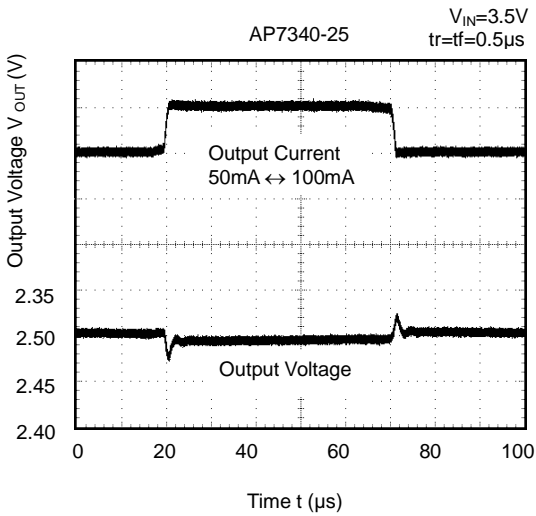
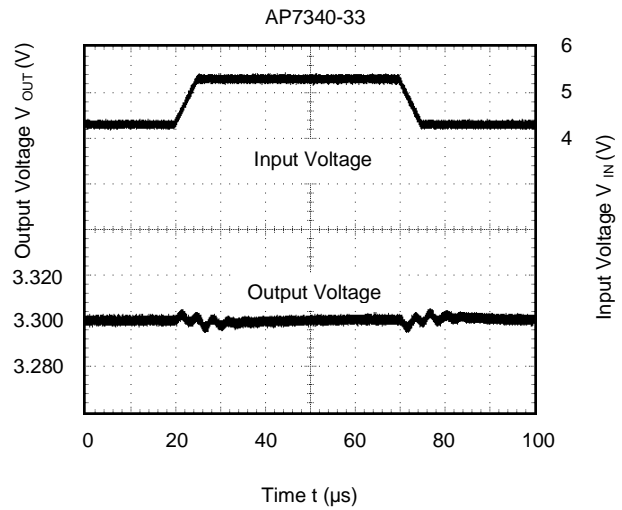
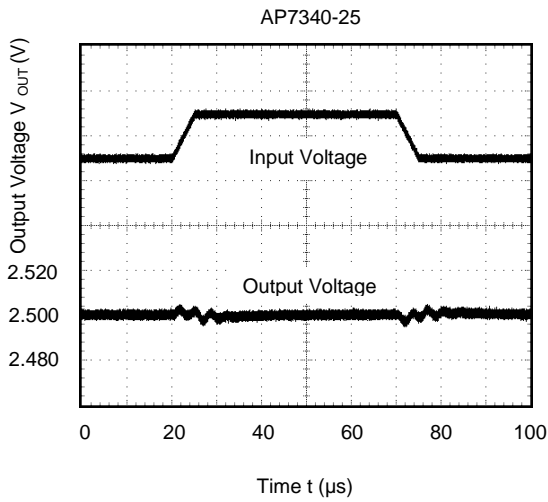

Typical Characteristics (cont.)

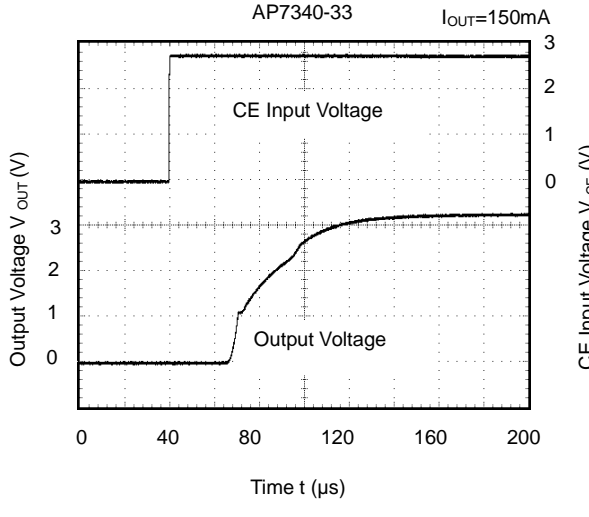
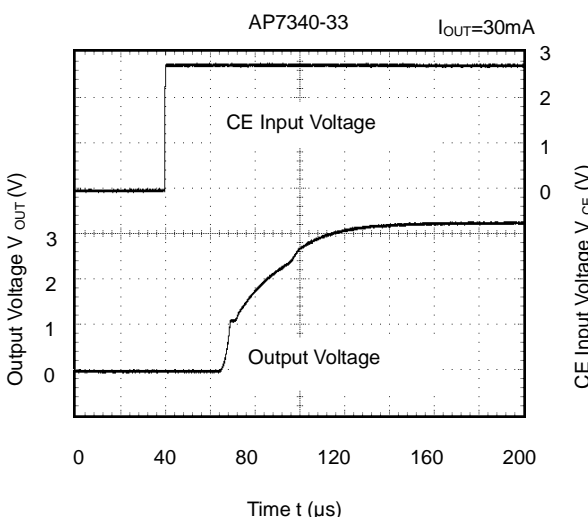
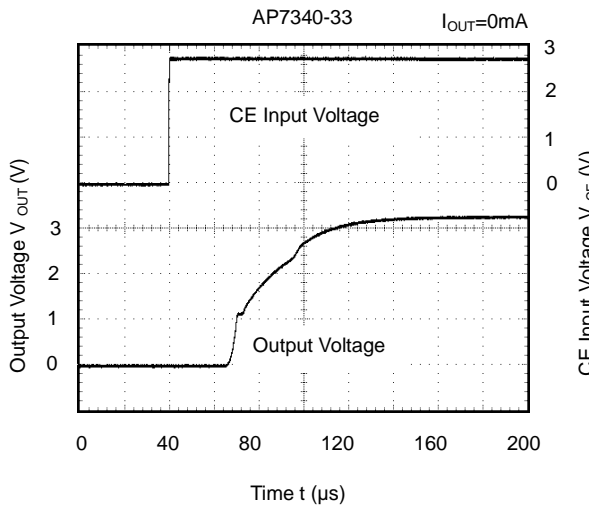
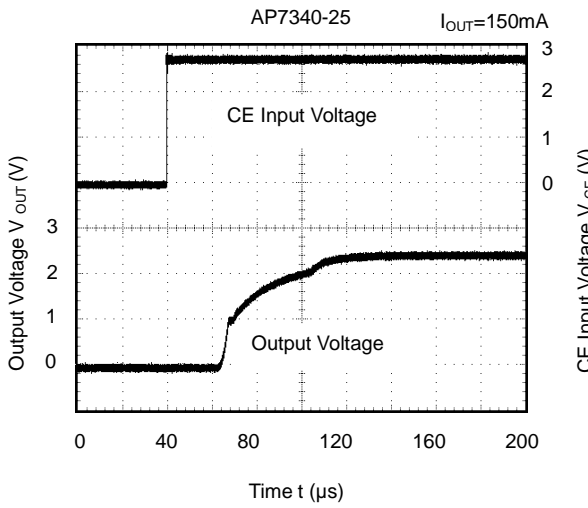
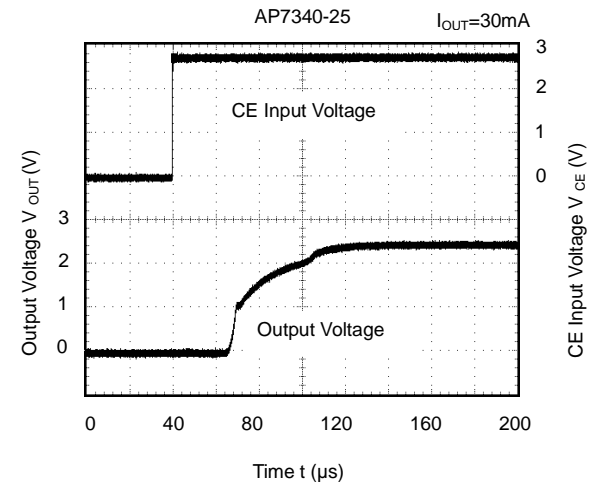
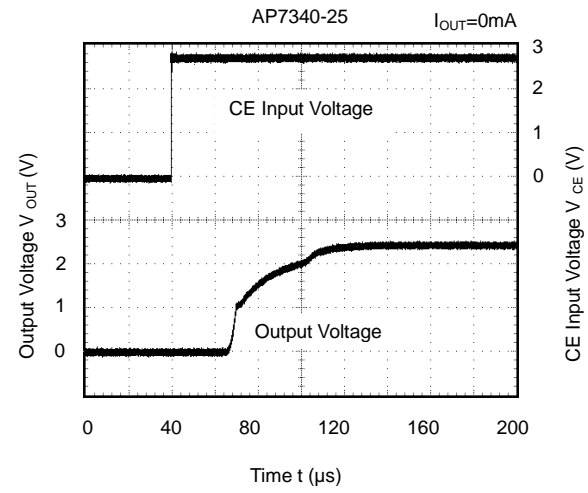

Typical Characteristics (cont.)

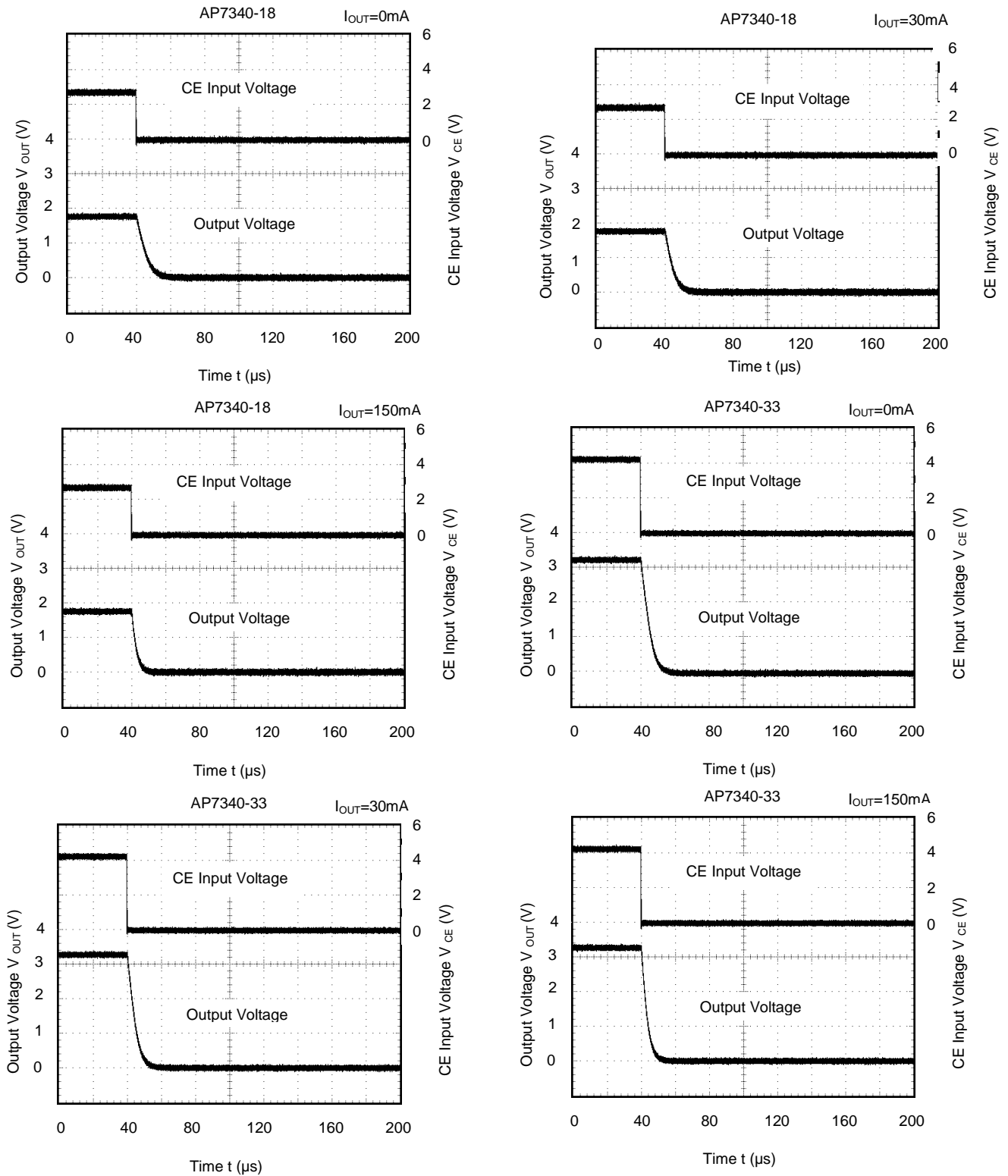

Application Information

Output Capacitor

An output capacitor (C_{OUT}) is needed to improve transient response and maintain stability. The AP7340 is stable with very small ceramic output capacitors. The ESR (equivalent series resistance) and capacitance drives the selection. If the application has large load variations, it is recommended to utilize low-ESR bulk capacitors. It is recommended to place ceramic capacitors as close as possible to the load and the ground pin and care should be taken to reduce the impedance in the layout.

Input Capacitor

To prevent the input voltage from dropping during load steps it is recommended to utilize an input capacitor (C_{IN}). A minimum $0.47\mu F$ ceramic capacitor is recommended between V_{IN} and GND pins to decouple input power supply glitch. This input capacitor must be located as close as possible to the device to assure input stability and reduce noise. For PCB layout, a wide copper trace is required for both V_{IN} and GND pins.

Enable Control

The AP7340 is turned on by setting the EN pin high, and is turned off by pulling it low. If this feature is not used, the EN pin should be tied to V_{IN} pin to keep the regulator output on at all time. To ensure proper operation, the signal source used to drive the EN pin must be able to swing above and below the specified turn-on/off voltage thresholds listed in the Electrical Characteristics section.

Short Circuit Protection

When V_{OUT} pin is short-circuit to GND, short circuit protection will be triggered and clamp the output current to approximately 60mA. This feature protects the regulator from overcurrent and damage due to overheating.

Layout Considerations

For good ground loop and stability, the input and output capacitors should be located close to the V_{in} , V_{out} , and Gnd pins of the device. The regulator Gnd pin should be connected to the external circuit ground to reduce voltage drop caused by trace impedance. Ground plane is generally used to reduce trace impedance. Wide trace should be used for large current paths from V_{IN} to V_{OUT} , and load circuit.

ESR vs. Output Current

Ceramic type output capacitor is recommended for this series; however, the other output capacitors with low ESR also can be used. The relations between I_{OUT} (Output Current) and ESR of an output capacitor are shown below. The stable region is marked as the hatched area in the graph.

Measurement conditions:

Frequency Band: 10Hz to 2MHz, Temperature: $-40^{\circ}C$ to $+85^{\circ}C$

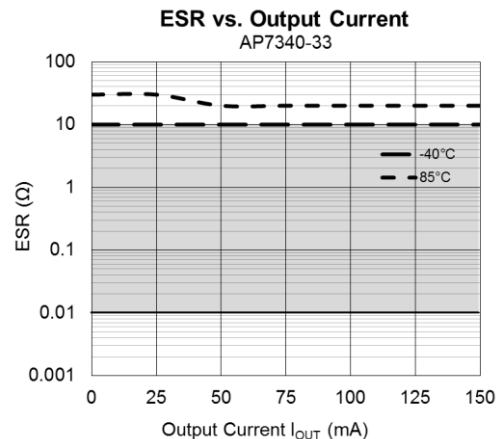
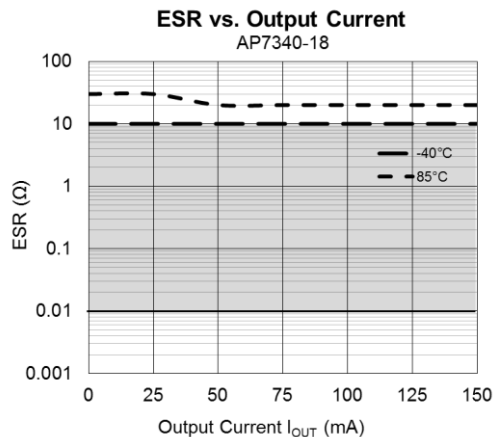

Ordering Information (Note 12)

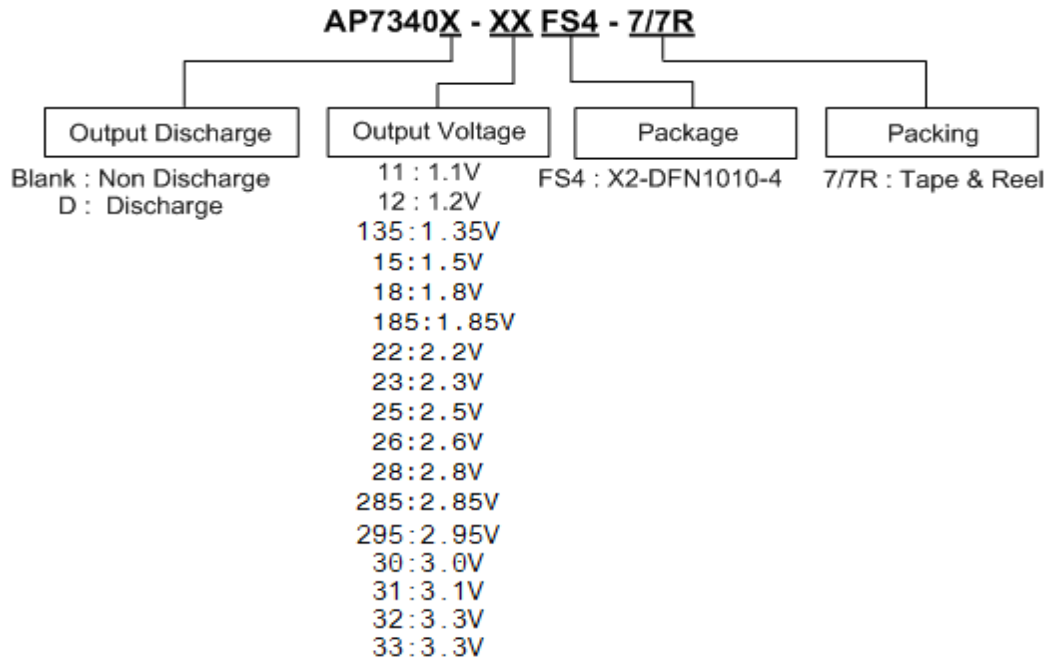

| Part Number | Package Code | Packaging | 7" Tape and Reel | |
|--------------------|--------------|--------------|-------------------|--------------------|
| | | | Quantity | Part Number Suffix |
| AP7340-XXFS4-7/7R | FS4 | X2-DFN1010-4 | 5,000/Tape & Reel | -7/7R |
| AP7340D-XXFS4-7/7R | FS4 | X2-DFN1010-4 | 5,000/Tape & Reel | -7/7R |

Note: 12. For packaging details, go to our website at <http://www.diodes.com/products/packages.html>.

Marking Information

X2-DFN1010-4

(Top View)

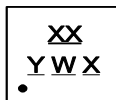

XX : Identification Code
 Y : Year : 0~9
 W : Week : A~Z : 1~26 week;
 a~z : 27~52 week; z represents
 52 and 53 week
 X : A~Z : Internal code

| Part Number | Package | Identification Code |
|-----------------|--------------|---------------------|
| AP7340-11FS4-7 | X2-DFN1010-4 | EA |
| AP7340-12FS4-7 | X2-DFN1010-4 | CH |
| AP7340-135FS4-7 | X2-DFN1010-4 | UP |
| AP7340-15FS4-7 | X2-DFN1010-4 | CJ |
| AP7340-18FS4-7 | X2-DFN1010-4 | CK |
| AP7340-185FS4-7 | X2-DFN1010-4 | EV |
| AP7340-22FS4-7 | X2-DFN1010-4 | CQ |
| AP7340-23FS4-7 | X2-DFN1010-4 | CV |
| AP7340-25FS4-7 | X2-DFN1010-4 | CM |
| AP7340-26FS4-7 | X2-DFN1010-4 | S2 |
| AP7340-28FS4-7 | X2-DFN1010-4 | CN |
| AP7340-285FS4-7 | X2-DFN1010-4 | EW |
| AP7340-295FS4-7 | X2-DFN1010-4 | 6A |
| AP7340-30FS4-7 | X2-DFN1010-4 | EX |
| AP7340-31FS4-7 | X2-DFN1010-4 | EY |
| AP7340-32FS4-7 | X2-DFN1010-4 | EZ |
| AP7340-33FS4-7 | X2-DFN1010-4 | CP |

Marking Information (cont.)

| Part Number | Package | Identification Code |
|-------------------|--------------|---------------------|
| AP7340D-11FS4-7 | X2-DFN1010-4 | EC |
| AP7340D-12FS4-7 | X2-DFN1010-4 | DG |
| AP7340D-135FS4-7 | X2-DFN1010-4 | UR |
| AP7340D-15FS4-7 | X2-DFN1010-4 | DH |
| AP7340D-18FS4-7 | X2-DFN1010-4 | DJ |
| AP7340D-185FS4-7 | X2-DFN1010-4 | DV |
| AP7340D-22FS4-7 | X2-DFN1010-4 | D8 |
| AP7340D-23FS4-7 | X2-DFN1010-4 | D9 |
| AP7340D-25FS4-7 | X2-DFN1010-4 | DK |
| AP7340D-26FS4-7 | X2-DFN1010-4 | S3 |
| AP7340D-28FS4-7 | X2-DFN1010-4 | DM |
| AP7340D-285FS4-7 | X2-DFN1010-4 | DW |
| AP7340D-295FS4-7 | X2-DFN1010-4 | 7A |
| AP7340D-30FS4-7 | X2-DFN1010-4 | DX |
| AP7340D-31FS4-7 | X2-DFN1010-4 | DY |
| AP7340D-32FS4-7 | X2-DFN1010-4 | DZ |
| AP7340D-33FS4-7 | X2-DFN1010-4 | DN |
| AP7340-11FS4-7R | X2-DFN1010-4 | 2A |
| AP7340-12FS4-7R | X2-DFN1010-4 | 2B |
| AP7340-135FS4-7R | X2-DFN1010-4 | 2T |
| AP7340-15FS4-7R | X2-DFN1010-4 | 2C |
| AP7340-18FS4-7R | X2-DFN1010-4 | 2D |
| AP7340-185FS4-7R | X2-DFN1010-4 | 2E |
| AP7340-22FS4-7R | X2-DFN1010-4 | 2F |
| AP7340-23FS4-7R | X2-DFN1010-4 | 2G |
| AP7340-25FS4-7R | X2-DFN1010-4 | 2H |
| AP7340-26FS4-7R | X2-DFN1010-4 | 2J |
| AP7340-28FS4-7R | X2-DFN1010-4 | 2K |
| AP7340-285FS4-7R | X2-DFN1010-4 | 2M |
| AP7340-295FS4-7R | X2-DFN1010-4 | 2U |
| AP7340-30FS4-7R | X2-DFN1010-4 | 2N |
| AP7340-31FS4-7R | X2-DFN1010-4 | 2P |
| AP7340-32FS4-7R | X2-DFN1010-4 | 2R |
| AP7340-33FS4-7R | X2-DFN1010-4 | 2S |
| AP7340D-11FS4-7R | X2-DFN1010-4 | 3A |
| AP7340D-12FS4-7R | X2-DFN1010-4 | 3B |
| AP7340D-135FS4-7R | X2-DFN1010-4 | 3T |
| AP7340D-15FS4-7R | X2-DFN1010-4 | 3C |
| AP7340D-18FS4-7R | X2-DFN1010-4 | 3D |
| AP7340D-185FS4-7R | X2-DFN1010-4 | 3E |
| AP7340D-22FS4-7R | X2-DFN1010-4 | 3F |
| AP7340D-23FS4-7R | X2-DFN1010-4 | 3G |
| AP7340D-25FS4-7R | X2-DFN1010-4 | 3H |
| AP7340D-26FS4-7R | X2-DFN1010-4 | 3J |
| AP7340D-28FS4-7R | X2-DFN1010-4 | 3K |
| AP7340D-285FS4-7R | X2-DFN1010-4 | 3M |
| AP7340D-295FS4-7R | X2-DFN1010-4 | 3U |
| AP7340D-30FS4-7R | X2-DFN1010-4 | 3N |
| AP7340D-31FS4-7R | X2-DFN1010-4 | 3P |
| AP7340D-32FS4-7R | X2-DFN1010-4 | 3R |
| AP7340D-33FS4-7R | X2-DFN1010-4 | 3S |

Package Outline Dimensions (All dimensions in mm.)

Please see AP02001 at <http://www.diodes.com/datasheets/ap02001.pdf> for the latest version.

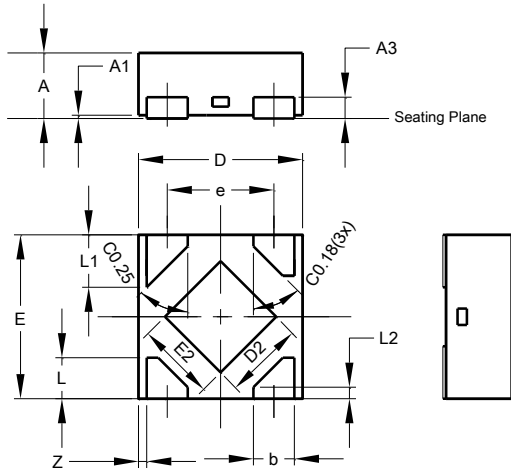

| X2-DFN1010-4 | | | |
|----------------------|------|------|-------|
| Dim | Min | Max | Typ |
| A | - | 0.40 | 0.39 |
| A1 | 0.00 | 0.05 | 0.02 |
| A3 | - | - | 0.13 |
| b | 0.20 | 0.30 | 0.25 |
| D | 0.95 | 1.05 | 1.00 |
| D2 | 0.38 | 0.58 | 0.48 |
| E | 0.95 | 1.05 | 1.00 |
| E2 | 0.38 | 0.58 | 0.48 |
| e | - | - | 0.65 |
| L | 0.20 | 0.30 | 0.25 |
| L1 | 0.27 | 0.37 | 0.32 |
| L2 | 0.02 | 0.12 | 0.07 |
| Z | - | - | 0.050 |
| All Dimensions in mm | | | |

Suggested Pad Layout

Please see AP02001 at <http://www.diodes.com/datasheets/ap02001.pdf> for the latest version.

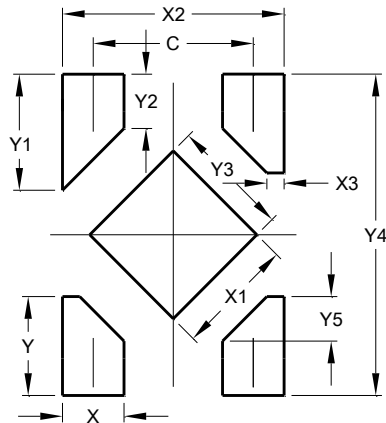

| Dimensions | Value (in mm) |
|------------|---------------|
| C | 0.650 |
| X | 0.250 |
| X1 | 0.480 |
| X2 | 0.900 |
| X3 | 0.070 |
| Y | 0.400 |
| Y1 | 0.470 |
| Y2 | 0.220 |
| Y3 | 0.480 |
| Y4 | 1.300 |
| Y5 | 0.180 |

Tape Orientation

For AP7340-XXFS4-7& AP7340D-XXFS4-7

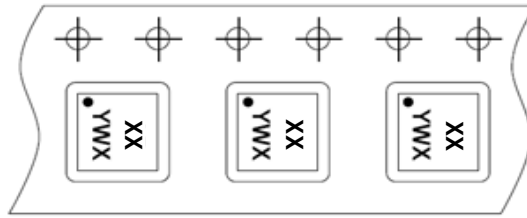

For AP7340-XXFS4-7R& AP7340D-XXFS4-7R

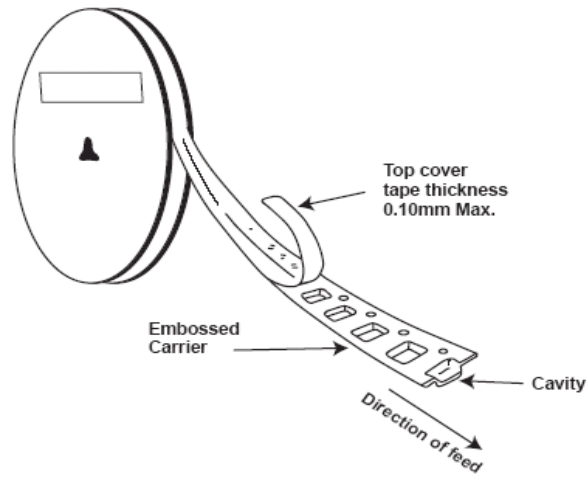
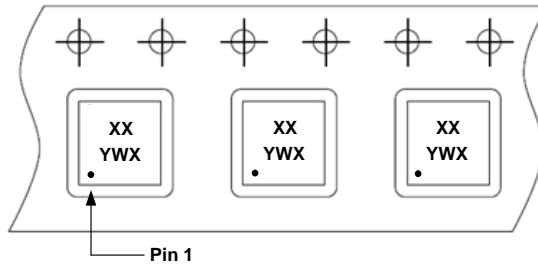

Note: 13. The taping orientation of the other package type can be found on our website at <http://www.diodes.com/datasheets/ap02007.pdf>.

IMPORTANT NOTICE

DIODES INCORPORATED MAKES NO WARRANTY OF ANY KIND, EXPRESS OR IMPLIED, WITH REGARDS TO THIS DOCUMENT, INCLUDING, BUT NOT LIMITED TO, THE IMPLIED WARRANTIES OF MERCHANTABILITY AND FITNESS FOR A PARTICULAR PURPOSE (AND THEIR EQUIVALENTS UNDER THE LAWS OF ANY JURISDICTION).

Diodes Incorporated and its subsidiaries reserve the right to make modifications, enhancements, improvements, corrections or other changes without further notice to this document and any product described herein. Diodes Incorporated does not assume any liability arising out of the application or use of this document or any product described herein; neither does Diodes Incorporated convey any license under its patent or trademark rights, nor the rights of others. Any Customer or user of this document or products described herein in such applications shall assume all risks of such use and will agree to hold Diodes Incorporated and all the companies whose products are represented on Diodes Incorporated website, harmless against all damages.

Diodes Incorporated does not warrant or accept any liability whatsoever in respect of any products purchased through unauthorized sales channel. Should Customers purchase or use Diodes Incorporated products for any unintended or unauthorized application, Customers shall indemnify and hold Diodes Incorporated and its representatives harmless against all claims, damages, expenses, and attorney fees arising out of, directly or indirectly, any claim of personal injury or death associated with such unintended or unauthorized application.

Products described herein may be covered by one or more United States, international or foreign patents pending. Product names and markings noted herein may also be covered by one or more United States, international or foreign trademarks.

This document is written in English but may be translated into multiple languages for reference. Only the English version of this document is the final and determinative format released by Diodes Incorporated.

LIFE SUPPORT

Diodes Incorporated products are specifically not authorized for use as critical components in life support devices or systems without the express written approval of the Chief Executive Officer of Diodes Incorporated. As used herein:

A. Life support devices or systems are devices or systems which:

1. are intended to implant into the body, or
2. support or sustain life and whose failure to perform when properly used in accordance with instructions for use provided in the labeling can be reasonably expected to result in significant injury to the user.

B. A critical component is any component in a life support device or system whose failure to perform can be reasonably expected to cause the failure of the life support device or to affect its safety or effectiveness.

Customers represent that they have all necessary expertise in the safety and regulatory ramifications of their life support devices or systems, and acknowledge and agree that they are solely responsible for all legal, regulatory and safety-related requirements concerning their products and any use of Diodes Incorporated products in such safety-critical, life support devices or systems, notwithstanding any devices- or systems-related information or support that may be provided by Diodes Incorporated. Further, Customers must fully indemnify Diodes Incorporated and its representatives against any damages arising out of the use of Diodes Incorporated products in such safety-critical, life support devices or systems.

Copyright © 2015, Diodes Incorporated

www.diodes.com

单击下面可查看定价，库存，交付和生命周期等信息

[>>Diodes Incorporated\(达尔科技\)](#)