

Description

The AP22802 is a single channel current-limited integrated high-side power switch optimized for Universal Serial Bus (USB) and other hot-swap applications. The family of devices complies with USB standards and is available with both polarities of Enable input.

The device has fast short-circuit response time for improved overall system robustness, and has an integrated output discharge function to ensure completely controlled discharging of the output voltage capacitor. They provide a complete protection solution for applications subject to heavy capacitive loads and the prospect of short circuit, and offer reverse current blocking, over-current, over-temperature and short-circuit protection, as well as controlled rise time and under-voltage lockout functionality. A 6ms deglitch capability on the open-drain Flag output prevents false over-current reporting and does not require any external components.

The AP22802 is available in a standard Green SOT25 and RoHS compliant.

Features

- Integrated Single Channel Load Switch
- Protection
 - Over Current with Auto Recovery
 - Short Circuit with Auto Recovery
 - Over Temperature with Auto Recovery
- Small Form Factor Packages
SOT25 – Footprint of just 9mm²
- Thermally Efficient Low Profile Package
- **Totally Lead-Free & Fully RoHS Compliant (Notes 1 & 2)**
- **Halogen and Antimony Free. "Green" Device (Note 3)**
- UL Recognized, File Number E322375
- IEC60950-1 CB Scheme Certified

Notes: 1. No purposely added lead. Fully EU Directive 2002/95/EC (RoHS), 2011/65/EU (RoHS 2) & 2015/863/EU (RoHS 3) compliant.
 2. See <https://www.diodes.com/quality/lead-free/> for more information about Diodes Incorporated's definitions of Halogen- and Antimony-free, "Green" and Lead-free.
 3. Halogen- and Antimony-free "Green" products are defined as those which contain <900ppm bromine, <900ppm chlorine (<1500ppm total Br + Cl) and <1000ppm antimony compounds.

Pin Assignments

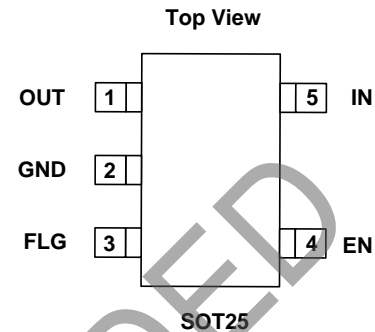

Applications

- Integrated Load Switches in Ultrabook PC's
- Power Up/Down Sequencing in Ultrabook PC's
- Notebook
- Netbook
- Set-Top Boxes
- SSD (Solid State Drives)
- Consumer Electronics
- Tablet PC
- Telecom Systems

Typical Applications Circuit

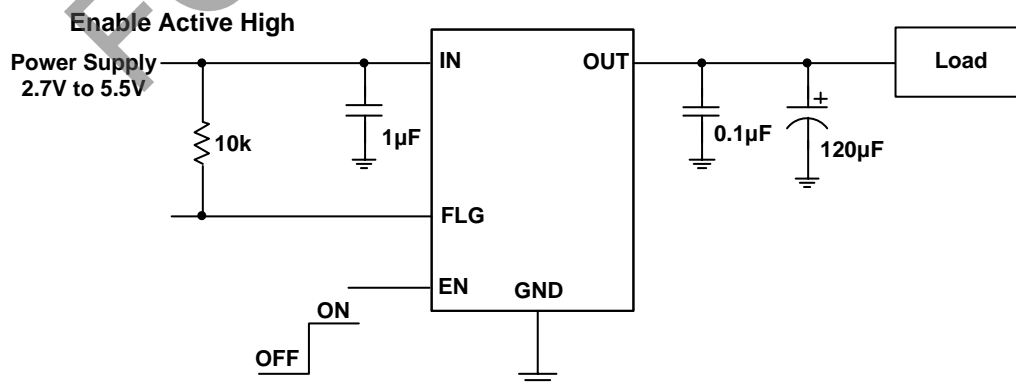

Pin Descriptions

Pin Number	Pin Name	Function
1	OUT	Voltage Output Pin
2	GND	Ground Pin of the Circuitry
3	FLG	Over Current and Over temperature fault report; Open-Drain flag is active low when triggered.
4	EN	Enable Input
		AP22802A: Active High
		AP22802B: Active Low
5	IN	Voltage Input Pin

Functional Block Diagram

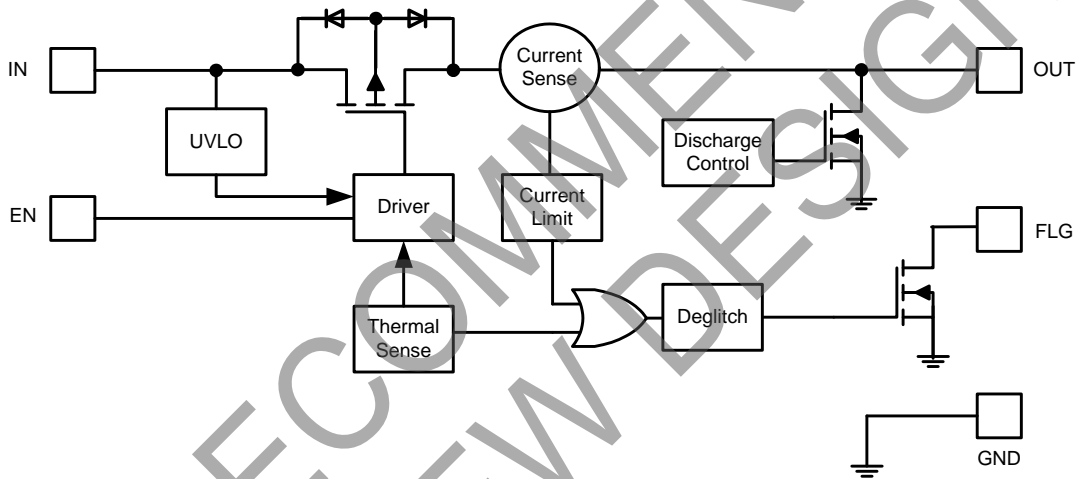

Absolute Maximum Ratings (@ T_A = +25°C, unless otherwise specified.) (Note 4)

Symbol	Parameter	Ratings	Unit	
ESD HBM	Human Body ESD Protection	2000	V	
ESD MM	Machine Model ESD Protection	200	V	
V _{IN}	Input Voltage	-0.3 to 5.7	V	
V _{OUT}	Output Voltage	-0.3 to (V _{IN} + 0.3)	V	
V _{EN}	Enable Voltage	-0.3 to (V _{IN} + 0.3)	V	
I _L	Load Current	Internal Limited	A	
T _{J(max)}	Maximum Junction Temperature	+150	°C	
T _{ST}	Storage Temperature	-65 to +150	°C	
R _{θJA}	Thermal Resistance, Junction to Ambient	SOT25 (Note 5)	180	°C/W
R _{θJC}	Thermal Resistance, Junction to Case	SOT25 (Note 5)	50	°C/W

- Notes:
- Stresses greater than the 'Absolute Maximum Ratings' specified above can cause permanent damage to the device. These are stress ratings only; functional operation of the device at these or any other conditions exceeding those indicated in this specification is not implied. Device reliability can be affected by exposure to absolute maximum rating conditions for extended periods of time.
 - Test condition for SOT25: Device mounted on 1"×1" FR-4 substrate PC board, 2oz copper with minimum recommended pad layout.

Recommended Operating Conditions (Note 6)

Symbol	Parameter	Min	Max	Unit
V _{IN}	Input Voltage	2.7	5.5	V
I _{OUT}	Output Current	0	2	A
V _{IL}	EN Input Logic Low Voltage	0	0.5	V
V _{IH}	EN Input Logic High Voltage	1.5	V _{IN}	V
T _A	Operating Ambient Temperature	-40	+85	°C

Electrical Characteristics (V_{IN} = 5V @ T_A = +25°C, C_{IN} = 1μF, C_L = 100nF, unless otherwise specified.)

Symbol	Parameter	Test Conditions	Min	Typ	Max	Unit
V _{UVLO}	Input UVLO	V _{IN} Rising	1.6	2.0	2.4	V
ΔV _{UVLO}	Input UVLO Hysteresis	V _{IN} Decreasing	—	75	—	mV
I _{SHDN}	Input Shutdown Current	Disabled, OUT = Open	—	0.1	1	μA
I _Q	Input Quiescent Current	Enabled, OUT = Open	—	50	—	μA
I _{LEAK}	Input Leakage Current	Disabled, OUT Grounded	—	0.1	1	μA
I _{REV}	Reverse Leakage Current	Disabled, V _{IN} = 0V, V _{OUT} = 5V, I _{REV} at V _{IN}	—	0.01	1	μA
R _{DS(ON)}	Switch On-Resistance	V _{IN} = 5V, I _{OUT} = 2.0A T _A = +25°C	—	50	—	mΩ
		V _{IN} = 3.3V, I _{OUT} = 2.0A T _A = +25°C	—	60	—	
I _{LIMIT}	Over Load Current Limit	V _{IN} = 5V, V _{OUT} = 4.5V	2.2	2.7	3.2	A
I _{SHORT}	Short-Circuit Current Limit	Enabled into Short Circuit	—	1.1	—	A
t _{SHORT}	Short-Circuit Response Time	V _{IN} = 5V, No Load Figure 1	—	0.7	—	μs
V _{IL}	EN Input Logic Low Voltage	V _{IN} = 2.7V to 5.5V	—	—	0.5	V
V _{IH}	EN Input Logic High Voltage	V _{IN} = 2.7V to 5.5V	1.5	—	—	V
I _{LEAK-EN}	EN Input Leakage	V _{IN} = 5V, V _{EN} = 0V and 5.5V	—	0.01	1	μA
I _{LEAK-O}	Output Leakage Current	Disabled, V _{OUT} = 0V	—	0.5	1	μA
t _{D(ON)}	Output Turn-On Delay Time	C _L = 4.7μF, R _{LOAD} = 10Ω @ V _{IN} = 3.3V Figure 2	—	1.7	—	ms
t _r	Output Turn-On Rise Time	C _L = 4.7μF, R _{LOAD} = 10Ω @ V _{IN} = 3.3V Figure 2	1.0	2.1	3.5	ms
t _{D(OFF)}	Output Turn-Off Delay Time	C _L = 4.7μF, R _{LOAD} = 10Ω @ V _{IN} = 3.3V Figure 2	—	0.2	—	ms
t _f	Output Turn-Off Fall Time	C _L = 4.7μF, R _{LOAD} = 100Ω @ V _{IN} = 3.3V Figure 2	—	0.65	—	ms
R _{FLG}	FLG output FET On-Resistance	I _{FLG} = 10mA	—	40	60	Ω
I _{FOH}	FLG Off Current	V _{FLG} = 5V	—	0.01	1	μA
t _{Blank}	FLG Blanking Time	Assertion or deassertion due to overcurrent and over-temperature condition	2	6	13	ms
t _{DIS}	Discharge Time	C _L = 1μF, V _{IN} = 5V, Disabled to V _{OUT} < 0.5V	—	0.4	—	ms
R _{DIS}	Discharge Resistance	V _{IN} = 5V, Disabled, I _{OUT} = 1mA	—	90	—	Ω
T _{SHDN}	Thermal Shutdown Threshold	Enabled	—	+140	—	°C
T _{HYS}	Thermal Shutdown Hysteresis	—	—	+60	—	°C

Note: 6. Refer to the typical application circuit.

Performance Characteristics

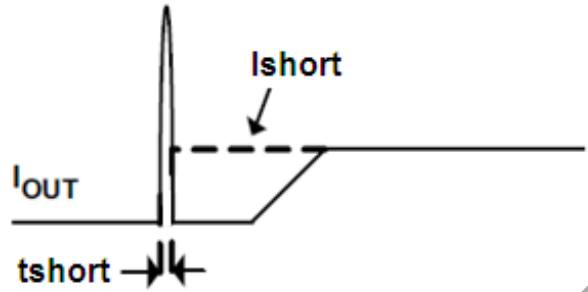

Figure 1. Response Time to Short Circuit Waveform

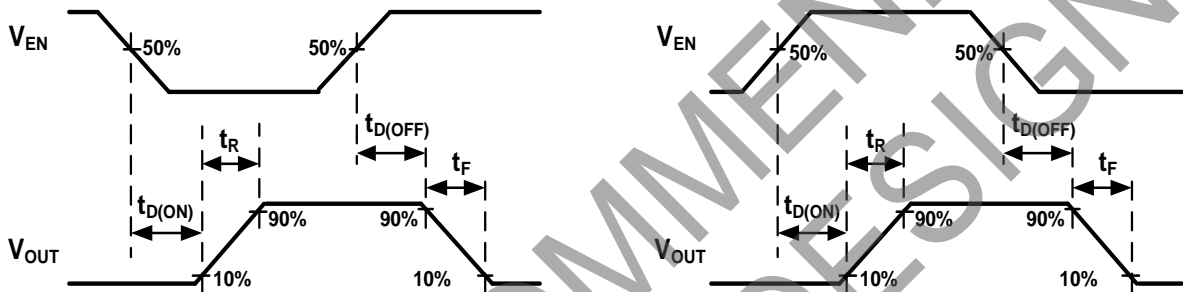
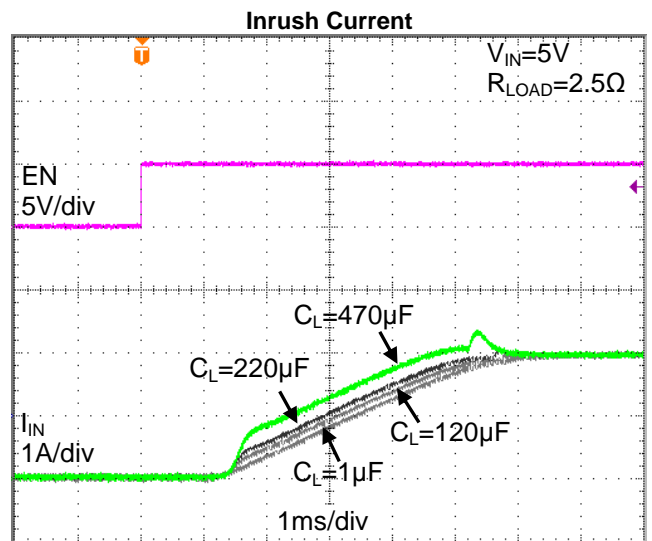
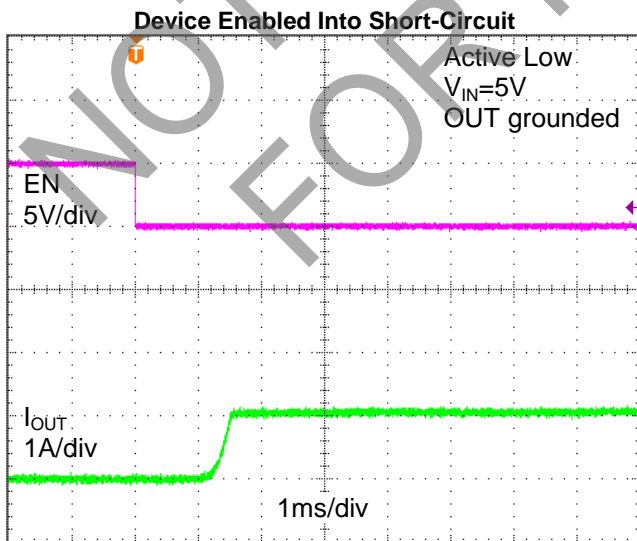
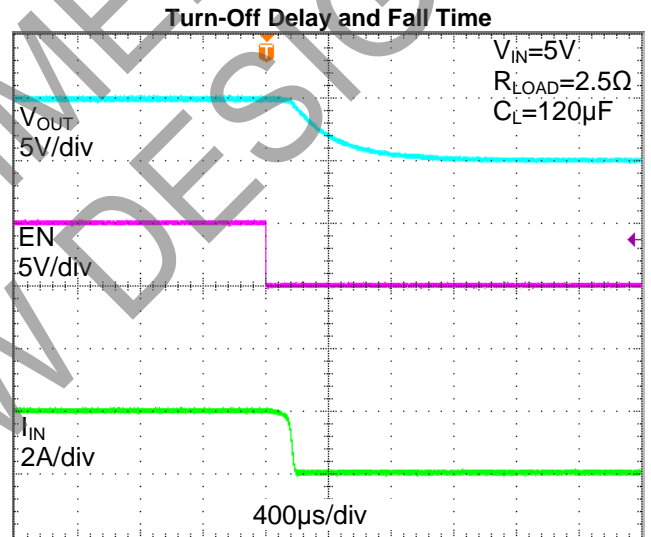
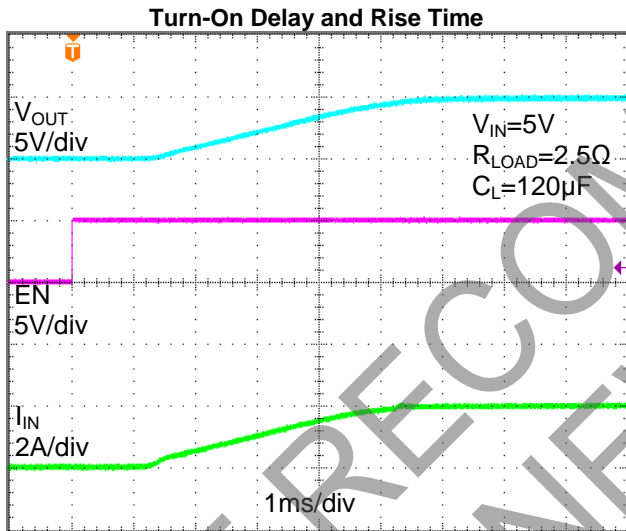
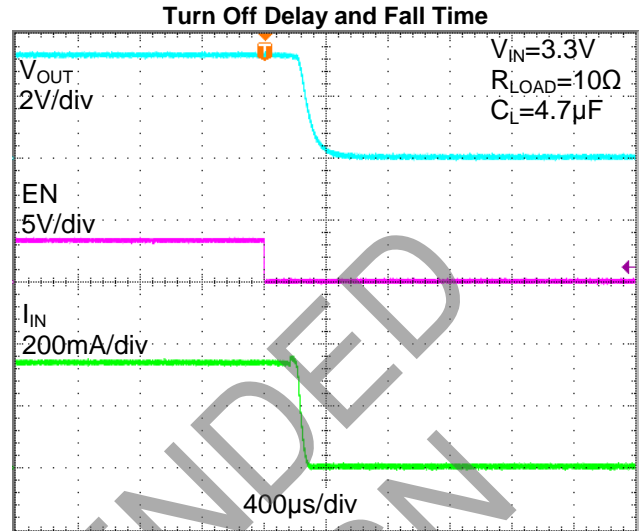
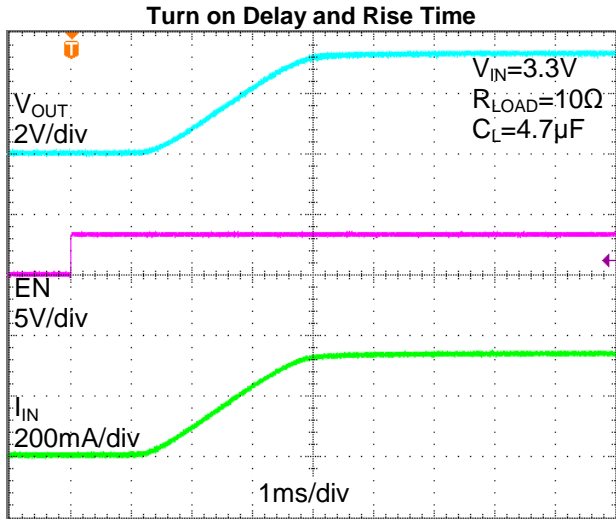

Figure 2. Voltage Waveforms: AP22802B (Active Low, left), AP22802A (Active High, right)

NOT RECOMMENDED FOR NEW DESIGN

Performance Characteristics (continued) ($T_A = +25^\circ\text{C}$, $V_{IN} = 5\text{V}$, $C_{IN} = 1\mu\text{F}$, $C_L = 0.1\mu\text{F}$, unless otherwise specified.)



Performance Characteristics (continued) ($T_A = +25^\circ\text{C}$, $V_{IN} = 5\text{V}$, $C_{IN} = 1\mu\text{F}$, $C_L = 0.1\mu\text{F}$, unless otherwise specified.)

Full-Load to Short-Circuit Transient Response

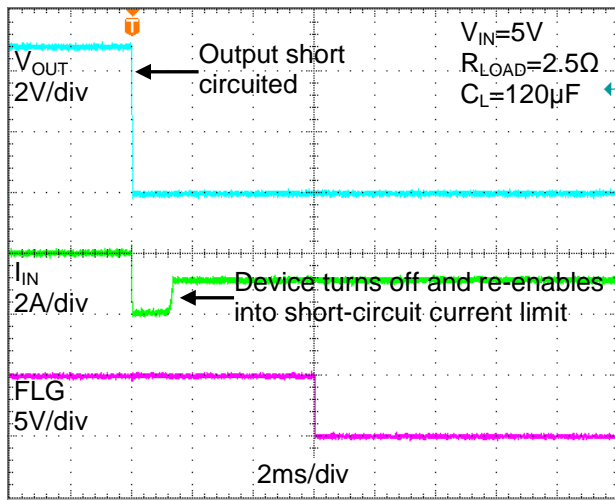

Short-Circuit to Full-Load Recovery Response

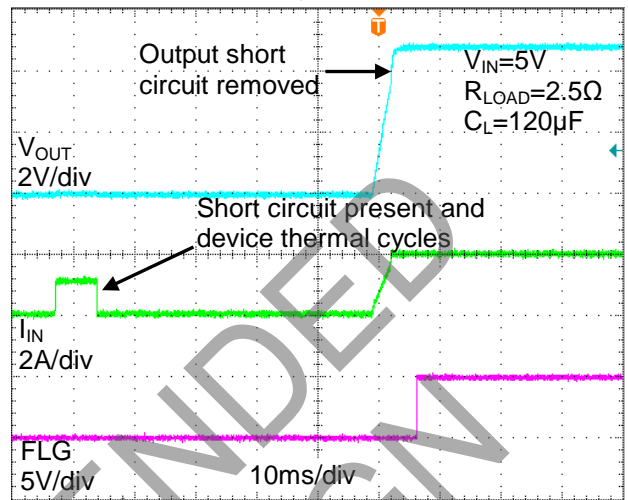

No-Load to Short-Circuit Transient Response

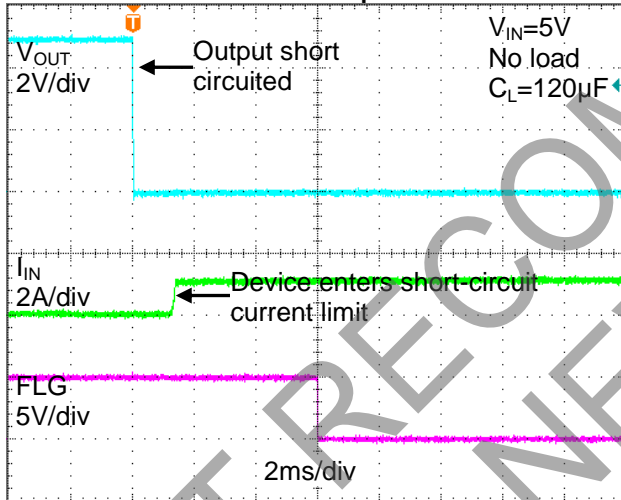

Short-Circuit to No-Load Recovery Response

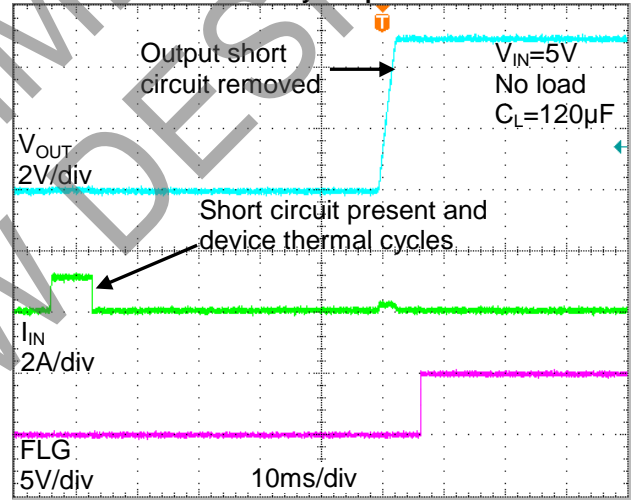

Power ON

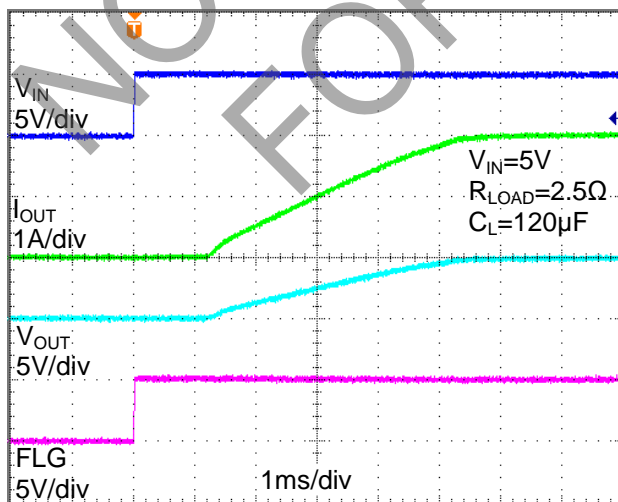

Short-Circuit with Blanking Time and Recovery

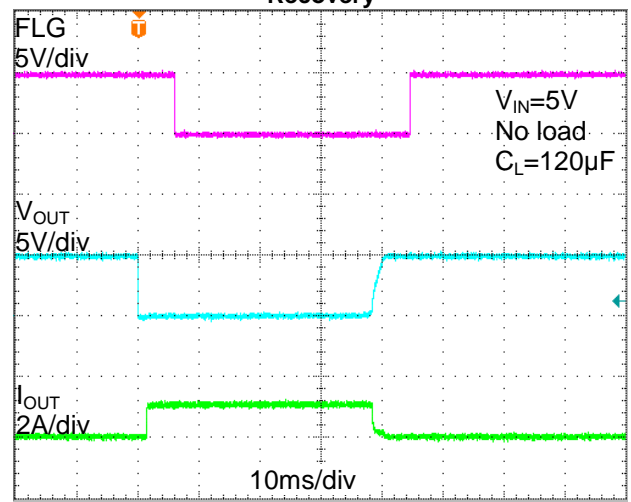

Performance Characteristics (continued) ($T_A = +25^\circ\text{C}$, $V_{IN} = 5\text{V}$, $C_{IN} = 1\mu\text{F}$, $C_L = 0.1\mu\text{F}$, unless otherwise specified.)

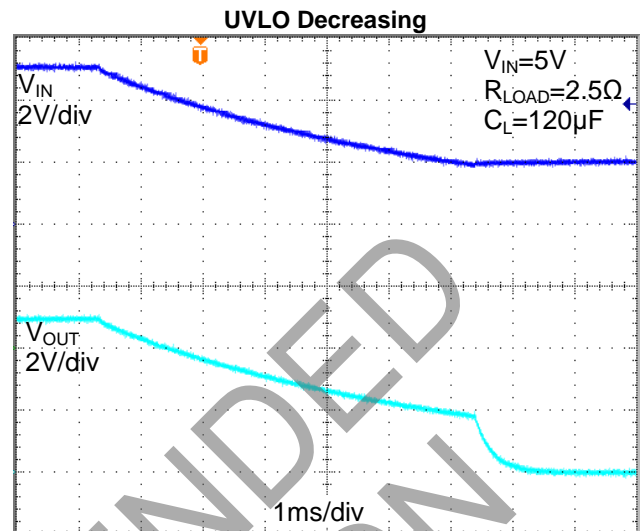
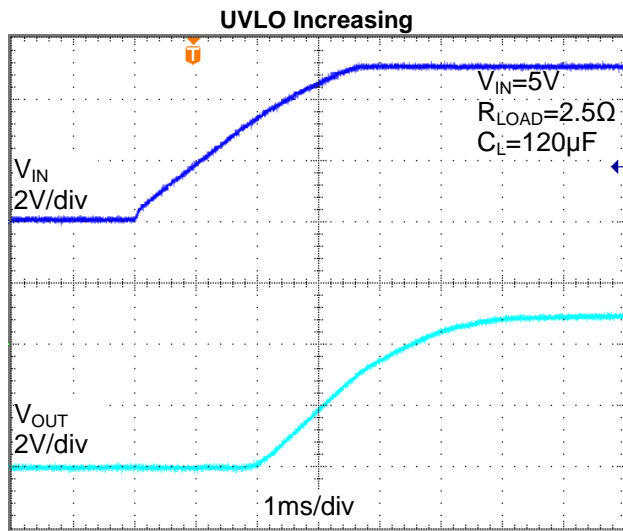

NOT RECOMMENDED FOR NEW DESIGN

Performance Characteristics (continued) ($T_A = +25^\circ\text{C}$, $V_{IN} = 5\text{V}$, $C_{IN} = 1\mu\text{F}$, $C_L = 0.1\mu\text{F}$, unless otherwise specified.)

Turn-on Time vs. Input Voltage

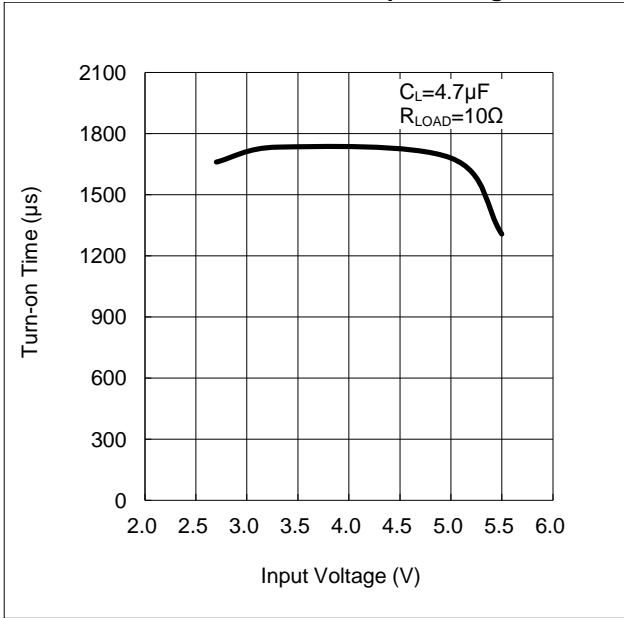

Turn-off Time vs. Input Voltage

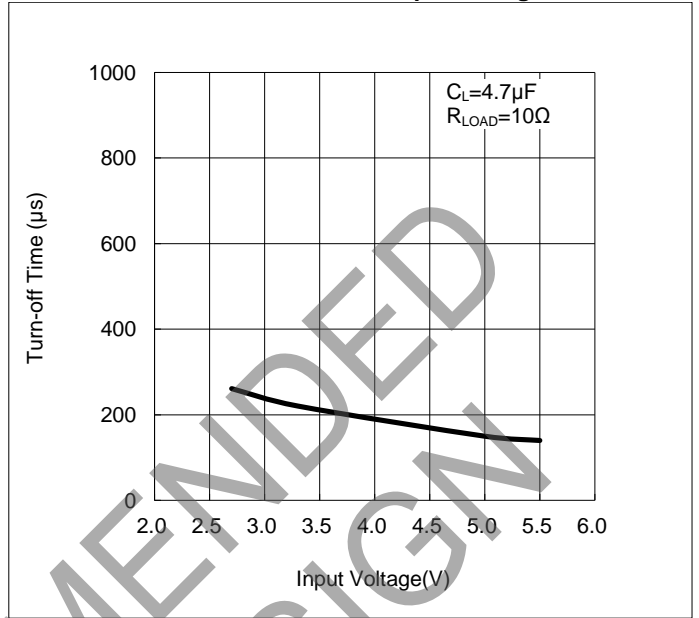

Rise Time vs. Input Voltage

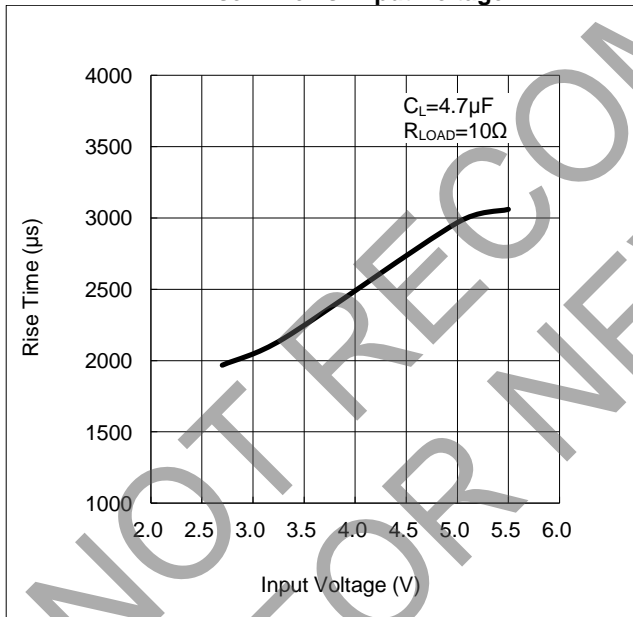

Fall Time vs. Input Voltage

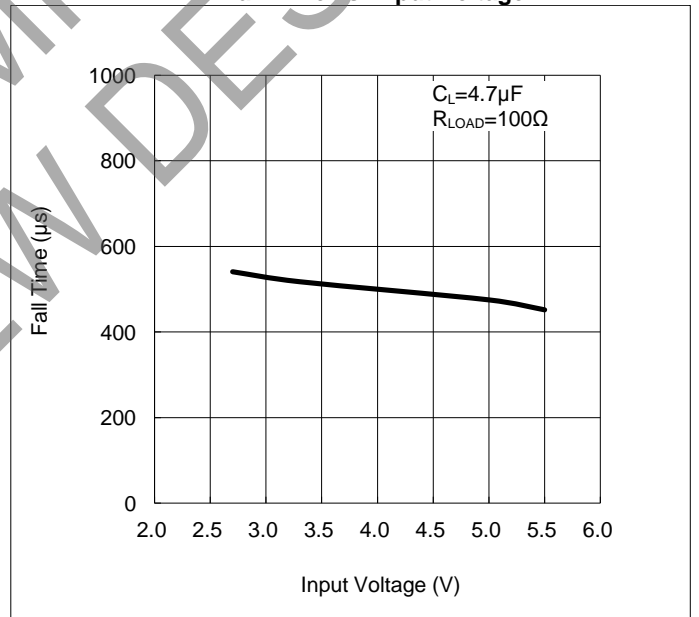

Performance Characteristics (continued) ($T_A = +25^\circ\text{C}$, $V_{IN} = 5\text{V}$, $C_{IN} = 1\mu\text{F}$, $C_L = 0.1\mu\text{F}$, unless otherwise specified.)

Supply Current vs. Temperature (Output Enabled)

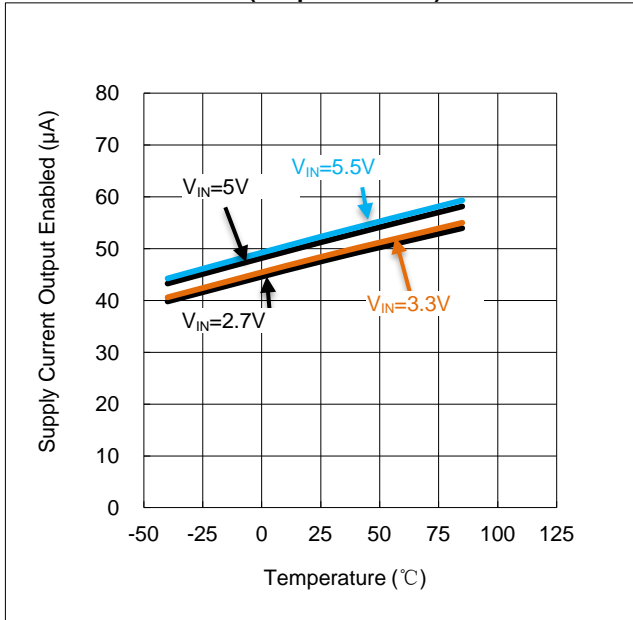

Supply Current vs. Temperature (Output Disabled)

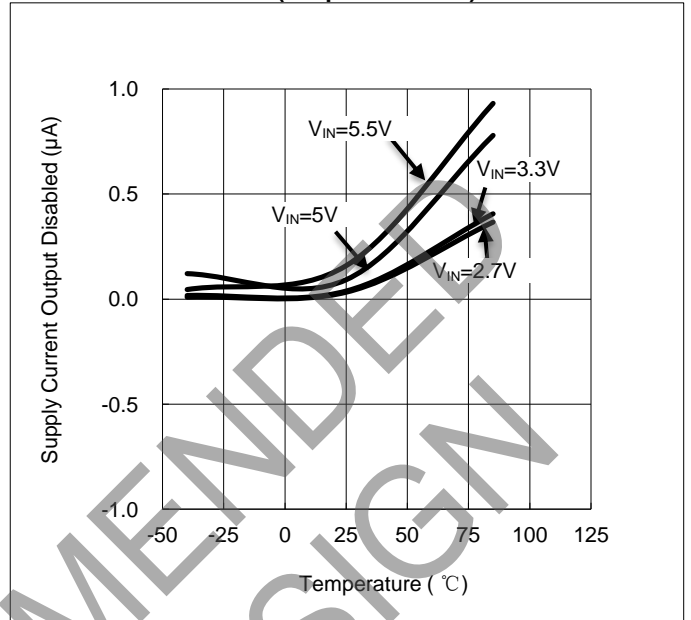

$R_{DS(ON)}$ vs. Temperature

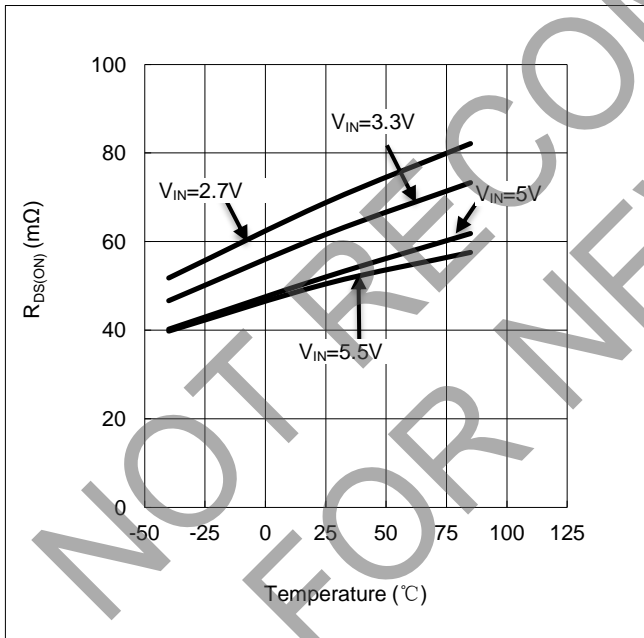

Short-Circuit Output Current vs. Temperature

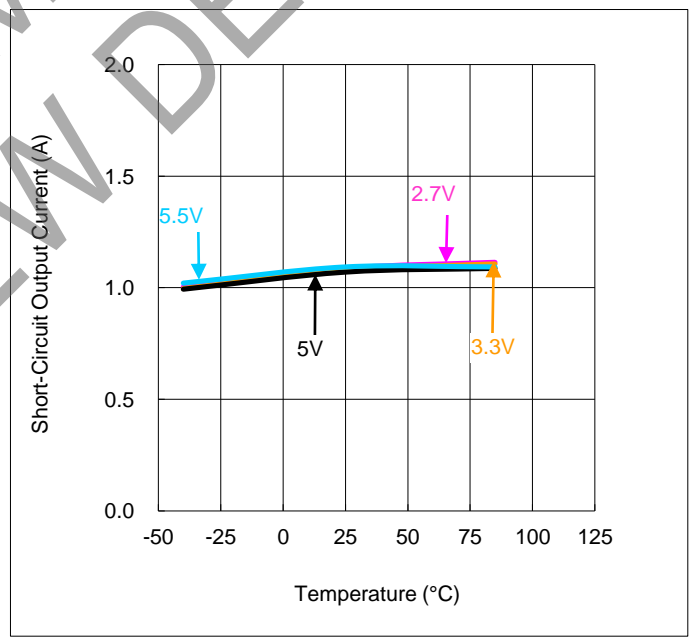

Performance Characteristics (continued) ($T_A = +25^\circ\text{C}$, $V_{IN} = 5\text{V}$, $C_{IN} = 1\mu\text{F}$, $C_L = 0.1\mu\text{F}$, unless otherwise specified.)

Under Voltage Lockout vs. Temperature

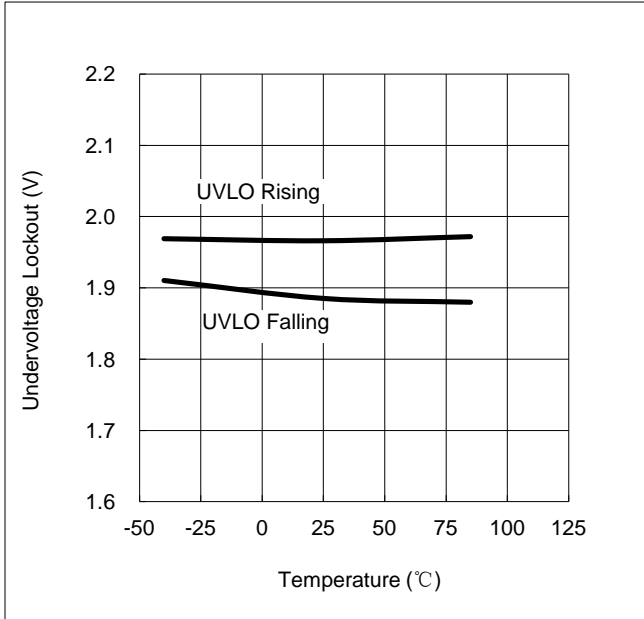

Over Load Current Limit vs. Input Voltage

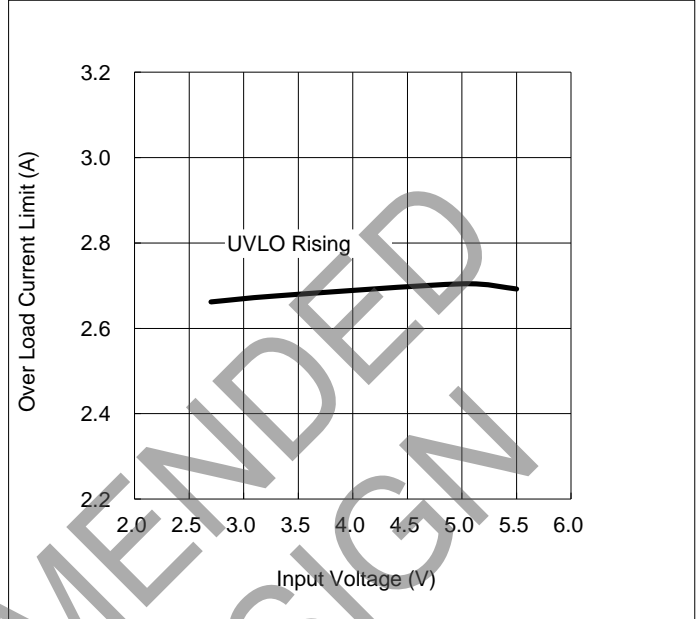

NOT RECOMMENDED FOR NEW DESIGN

Application Information

Power Supply Considerations

A 1 μ F X7R or X5R ceramic bypass capacitor between IN and GND, close to the device, is recommended. Placing a high-value capacitor (10 μ F minimum) on both input and output pins is recommended when the output transient load is heavy. This precaution reduces power-supply transients that may cause ringing on the input. Additionally, bypassing the output with a 0.01 μ F to 0.1 μ F ceramic capacitor improves the immunity of the device to short-circuit transients.

FLG Response

When an over-current or over-temperature shutdown condition is encountered, the FLG open-drain output goes active low after a nominal 6ms deglitch timeout. The FLG output remains low until both over-current and over-temperature conditions are removed. Connecting a heavy capacitive load to the output of the device can cause a momentary over-current condition, which does not trigger the FLG due to the 6ms deglitch timeout. The AP22802 is designed to eliminate false over-current reporting without the need of external components to remove unwanted pulses.

Over-Current and Short Circuit Protection

An internal sensing FET is employed to check for over-current conditions. Unlike current-sense resistors, sense FETs do not increase the series resistance of the current path. When an overcurrent condition is detected, the device maintains a constant output current and reduces the output voltage accordingly. Complete shutdown occurs only if the fault stays long enough to activate thermal limiting.

Three possible overload conditions can occur. In the first condition, the output has been shorted to GND before the device is enabled or before VIN has been applied. The AP22802 senses the short circuit and immediately clamps output current to a certain safe level.

In the second condition, an output short or an overload occurs while the device is enabled. At the instance the overload occurs, higher current may flow for a very short period of time before the current limit function can react. After the current limit function has tripped, the device switches into current limiting mode and the current is clamped at I_{LIMIT}, or I_{SHORT}.

In the third condition, the load has been gradually increased beyond the recommended operating current. The current is permitted to rise until the current-limit threshold (I_{TRIG}) is reached or until the thermal limit of the device is exceeded. The AP22802 is capable of delivering current up to the current-limit threshold without damaging the device. Once the threshold has been reached, the device switches into its current limiting mode and is set at I_{LIMIT}.

Thermal Protection

Thermal protection prevents the IC from damage when heavy-overload or short-circuit faults are present for extended periods of time. The AP22802 implements a thermal sensing to monitor the operating junction temperature of the power distribution switch. Once the die temperature rises to approximately +140°C due to excessive power dissipation in an over-current or short-circuit condition the internal thermal sense circuitry turns the power switch off, thus preventing the power switch from damage. Hysteresis is built into the thermal sense circuit allowing the device to cool down approximately +60°C before the switch turns back on. The switch continues to cycle in this manner until the load fault or input power is removed. The FLG open-drain output is asserted when an over-temperature shutdown or over-current occurs with 6ms deglitch.

ON/OFF Input Operator

The EN input allows the output current to be switched on and off using a GPIO compatible input. The high signal (switch on) should be at least 1.5V, and the low signal (switch off) no higher than 0.5V. This pin should NOT be left floating. It is advisable to hold the EN signal low when applying or removing power.

Under-voltage Lockout (UVLO)

Under-voltage lockout function (UVLO) keeps the internal power switch from being turned ON until the power supply has reached at least 2V, even if the switch is enabled. Whenever the input voltage falls below approximately 2V, the power switch is quickly turned off. This facilitates the design of hot-insertion systems where it is not possible to turn off the power switch before input power is removed.

Discharge Function

The discharge function of the device is active when enable is disabled or de-asserted. The discharge function with the N-MOS power switch implementation is activated and offers a resistive discharge path for the external storage capacitor. This is designed for discharging any residue of the output voltage when either no external output resistance or load resistance is present at the output.

Application Information (continued)

Power Dissipation and Junction Temperature

The low on-resistance of the internal MOSFET allows the small surface-mount packages to pass large current. Using the maximum operating ambient temperature (T_A) and $R_{DS(ON)}$, the power dissipation can be calculated by:

$$P_D = R_{DS(ON)} \times I^2$$

Finally, calculate the junction temperature:

$$T_J = P_D \times R_{\theta JA} + T_A$$

Where:

- T_A = Ambient temperature °C
- $R_{\theta JA}$ = Thermal resistance
- P_D = Total power dissipation

Ordering Information

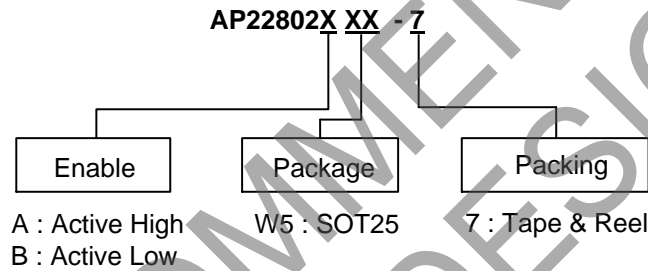

Part Number	Package Code	Packaging	7" Tape and Reel	
			Quantity	Part Number Suffix
AP22802AW5-7	W5	SOT25	3000/Tape & Reel	-7
AP22802BW5-7	W5	SOT25	3000/Tape & Reel	-7

Marking Information

(Top View)

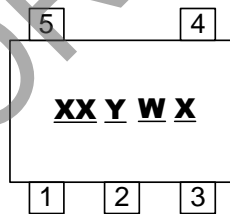

- XX** : Identification code
- Y** : Year 0~9
- W** : Week : A~Z : 1~26 week;
a~z : 27~52 week; z represents 52 and 53 week
- X** : A~Z : Green

Part Number	Package Type	Identification Code
AP22802AW5-7	SOT25	XA
AP22802BW5-7	SOT25	XB

Package Outline Dimensions

Please see <http://www.diodes.com/package-outlines.html> for the latest version.

SOT25

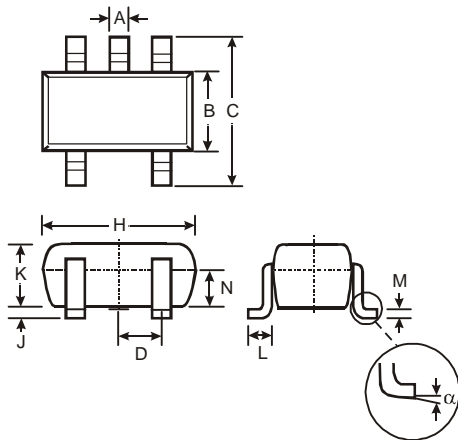

SOT25			
Dim	Min	Max	Typ
A	0.35	0.50	0.38
B	1.50	1.70	1.60
C	2.70	3.00	2.80
D	—	—	0.95
H	2.90	3.10	3.00
J	0.013	0.10	0.05
K	1.00	1.30	1.10
L	0.35	0.55	0.40
M	0.10	0.20	0.15
N	0.70	0.80	0.75
α	0°	8°	—
All Dimensions in mm			

Suggested Pad Layout

Please see <http://www.diodes.com/package-outlines.html> for the latest version.

SOT25

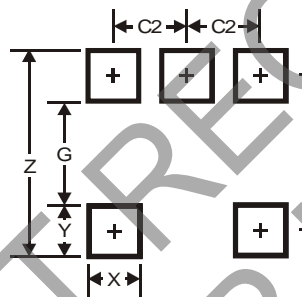

Dimensions	Value (in mm)
Z	3.20
G	1.60
X	0.55
Y	0.80
C1	2.40
C2	0.95

IMPORTANT NOTICE

DIODES INCORPORATED MAKES NO WARRANTY OF ANY KIND, EXPRESS OR IMPLIED, WITH REGARDS TO THIS DOCUMENT, INCLUDING, BUT NOT LIMITED TO, THE IMPLIED WARRANTIES OF MERCHANTABILITY AND FITNESS FOR A PARTICULAR PURPOSE (AND THEIR EQUIVALENTS UNDER THE LAWS OF ANY JURISDICTION).

Diodes Incorporated and its subsidiaries reserve the right to make modifications, enhancements, improvements, corrections or other changes without further notice to this document and any product described herein. Diodes Incorporated does not assume any liability arising out of the application or use of this document or any product described herein; neither does Diodes Incorporated convey any license under its patent or trademark rights, nor the rights of others. Any Customer or user of this document or products described herein in such applications shall assume all risks of such use and will agree to hold Diodes Incorporated and all the companies whose products are represented on Diodes Incorporated website, harmless against all damages.

Diodes Incorporated does not warrant or accept any liability whatsoever in respect of any products purchased through unauthorized sales channel. Should Customers purchase or use Diodes Incorporated products for any unintended or unauthorized application, Customers shall indemnify and hold Diodes Incorporated and its representatives harmless against all claims, damages, expenses, and attorney fees arising out of, directly or indirectly, any claim of personal injury or death associated with such unintended or unauthorized application.

Products described herein may be covered by one or more United States, international or foreign patents pending. Product names and markings noted herein may also be covered by one or more United States, international or foreign trademarks.

This document is written in English but may be translated into multiple languages for reference. Only the English version of this document is the final and determinative format released by Diodes Incorporated.

LIFE SUPPORT

Diodes Incorporated products are specifically not authorized for use as critical components in life support devices or systems without the express written approval of the Chief Executive Officer of Diodes Incorporated. As used herein:

A. Life support devices or systems are devices or systems which:

1. are intended to implant into the body, or
2. support or sustain life and whose failure to perform when properly used in accordance with instructions for use provided in the labeling can be reasonably expected to result in significant injury to the user.

B. A critical component is any component in a life support device or system whose failure to perform can be reasonably expected to cause the failure of the life support device or to affect its safety or effectiveness.

Customers represent that they have all necessary expertise in the safety and regulatory ramifications of their life support devices or systems, and acknowledge and agree that they are solely responsible for all legal, regulatory and safety-related requirements concerning their products and any use of Diodes Incorporated products in such safety-critical, life support devices or systems, notwithstanding any devices- or systems-related information or support that may be provided by Diodes Incorporated. Further, Customers must fully indemnify Diodes Incorporated and its representatives against any damages arising out of the use of Diodes Incorporated products in such safety-critical, life support devices or systems.

Copyright © 2019, Diodes Incorporated

www.diodes.com

单击下面可查看定价，库存，交付和生命周期等信息

[>>Diodes Incorporated\(达达科技\(美台\)\)](#)