

Description

The DPO2036 provides 4 channels of over-voltage protection over the CC1/2 & SBU1/2 pins which are connected to the USB Type-C® connector. The 4 channels are divided into two pairs, one pair of channels protect the CC1 and CC2 pins from being shorted to the V_{BUS} , one pair of channels protect the SBU1 and SBU2 pins from being shorted to the V_{BUS} . Whenever the voltage threshold set for any of the two pairs of channels is reached, the exception condition becomes valid and the low-active flag FAULTB is subsequently asserted.

This device is designed to draw its operating voltage primarily from the system power, V_{SYS} , which is either the always-ON 3.3V/5V existed within the system or the 1-cell battery inside the mobile system. Under the circumstance when the battery inside a mobile system is fully depleted, DPO2036 can obtain power from the external peripheral system connected to the USB Type-C connector. The DPO2036 supports the dead battery mode by having both of the CC1C and CC2C pins tied to the pull-down resistor R_D (resistor value per the USB Type-C Specification) embedded in the device.

The DPO2036 is housed in the low-profile and space-saving U-QFN2020-12 (Type B) package which is manufactured with environmental-friendly material.

Features

- Operating Voltage Range: 2.7V to 5.5V
- 4-Channel Over-Voltage Protection with Auto-Recovery
- $R_{DS(ON)}$ of OVP MOSFET for CC-Pin Protection: 350m Ω Typical
- $R_{DS(ON)}$ of OVP MOSFET for SBU-Pin Protection: 5 Ω Typical
- C_{IN} of OVP MOSFET for CC-Pin Protection: 50pF
- C_{IN} of OVP MOSFET for SBU-Pin Protection: 5pF
- Dead Battery Support for CC Lines
- Built-In Over-Temperature Protection
- IEC61000-4-2 ESD Protection on CC1C, CC2C, SBU1C, SBU2C
- **Totally Lead-Free & Fully RoHS Compliant (Notes 1 & 2)**
- **Halogen and Antimony Free. "Green" Device (Note 3)**
- **For automotive applications requiring specific change control (i.e. parts qualified to AEC-Q100/101/200, PPAP capable, and manufactured in IATF 16949 certified facilities), please [contact us](https://www.diodes.com) or your local Diodes representative.**
<https://www.diodes.com/quality/product-definitions/>

Notes: 1. No purposely added lead. Fully EU Directive 2002/95/EC (RoHS), 2011/65/EU (RoHS 2) & 2015/863/EU (RoHS 3) compliant.
2. See <https://www.diodes.com/quality/lead-free/> for more information about Diodes Incorporated's definitions of Halogen- and Antimony-free, "Green" and Lead-free.
3. Halogen- and Antimony-free "Green" products are defined as those which contain <900ppm bromine, <900ppm chlorine (<1500ppm total Br + Cl) and <1000ppm antimony compounds.

Pin Assignments

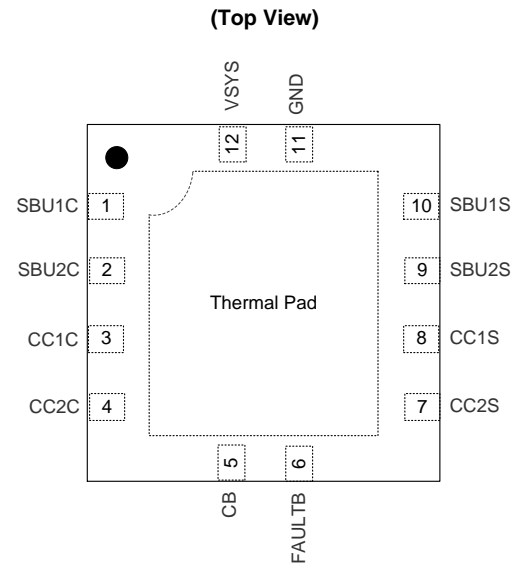

U-QFN2020-12 (Type B)

Applications

- Notebook/Desktop/AIO PCs, Tablets, Mobile Phones
- VR/AR Headsets
- Docking Stations, Universal & Multimedia Hubs
- FPTVs, PC Monitors
- Set-Top-Boxes, Residential Gateways, Storage Devices
- Universal AC/DC Chargers/Adapters

Typical Application Circuit

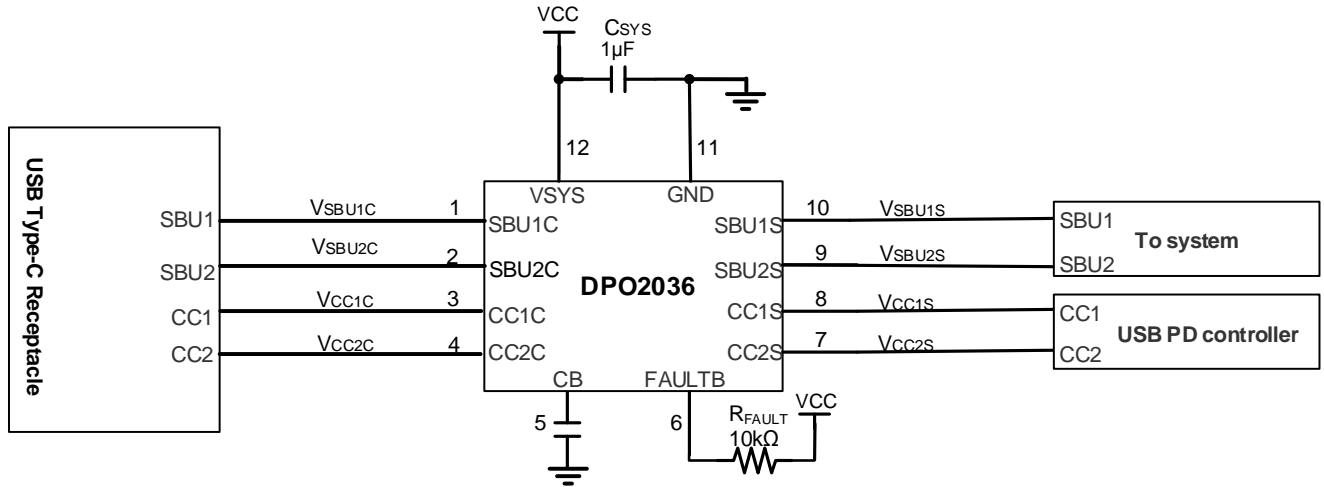

Figure 1. Typical Application Circuit

Pin Descriptions

Pin Number	Pin Name	Function
1	SBU1C	SBU1 connector side. This shall be connected to the SBU1 pin of the USB Type-C connector.
2	SBU2C	SBU2 connector side. This shall be connected to the SBU2 pin of the USB Type-C connector.
3	CC1C	CC1 connector side. This shall be connected to the CC1 pin of the USB Type-C connector.
4	CC2C	CC2 connector side. This shall be connected to the CC2 pin of the USB Type-C connector.
5	CB	Pin for ESD support capacitor. Place a 0.1µF capacitor on this pin to ground
6	FAULTB	Fault status. This is an active-low open-drain output.
7	CC2S	CC2 system side. This shall be connected to the CC2 pin of the component to be protected.
8	CC1S	CC1 system side. This shall be connected to the CC1 pin of the component to be protected.
9	SBU2S	SBU2 system side. This shall be connected to the SBU2 pin of the component to be protected.
10	SBU1S	SBU1 system side. This shall be connected to the SBU1 pin of the component to be protected.
11	GND	Ground.
12	VSYS	Power Input. This shall be connected to the 2.7 to 5.5V power source inside the system.
—	Thermal Pad	Need to connect pad to the PCB ground plane. It serves as a heatsink.

Functional Block Diagram

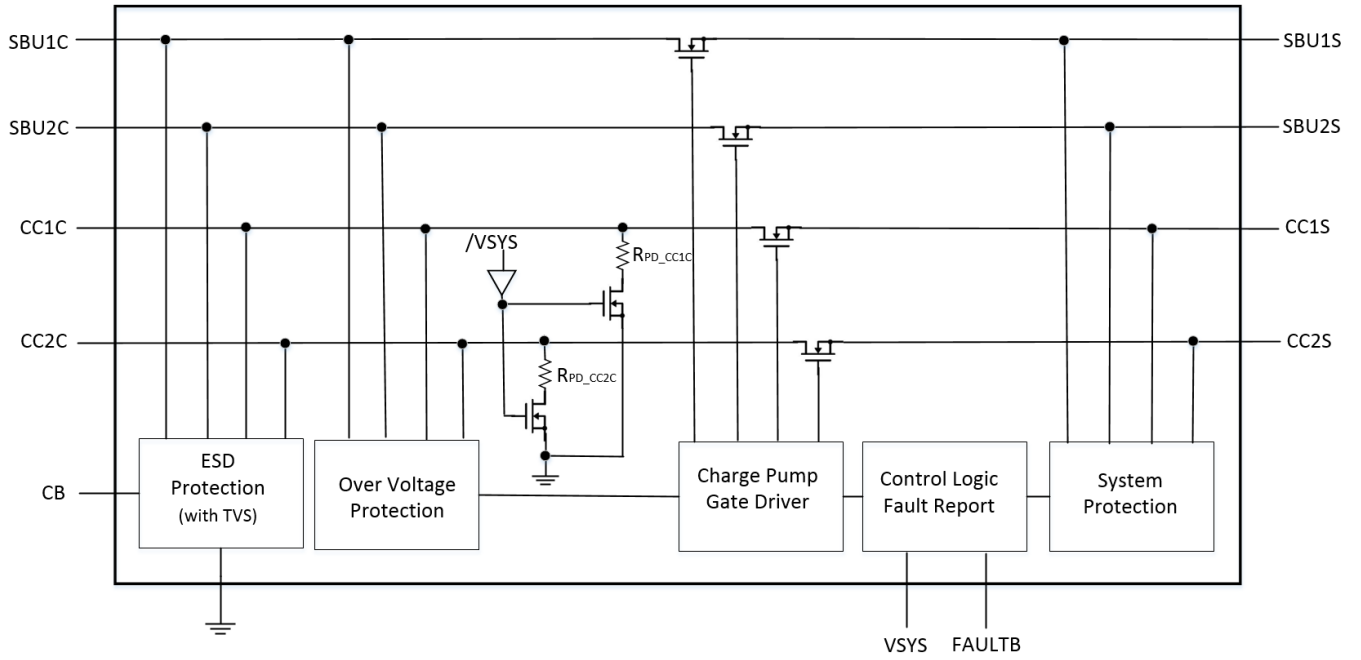

Figure 2. Internal Functional Blocks

Absolute Maximum Ratings (@ $T_A = +25^\circ\text{C}$, unless otherwise specified.) (Note 4)

Symbol	Parameter	Rating	Unit
V_{SYS}	Voltage Range of VSYS Pin	-0.3 to 6.0	V
V_{FAULTB}	Voltage Range of FAULTB Pin	-0.3 to 6.0	V
$V_{\text{SBUxS}}, V_{\text{CCxS}}$	Voltage Range of SBU1S, SBU2S, CC1S, CC2S Pins	-0.3 to 6.0	V
$V_{\text{SBUxC}}, V_{\text{CCxC}}$	Voltage Range of SBU1C, SBU2C, CC1C, CC2C Pins	-0.3 to 24.0	V
T_J	Operating Junction Temperature	-40 to +125	$^\circ\text{C}$
T_L	Lead Temperature	+260	$^\circ\text{C}$
T_{STG}	Storage Temperature	-65 to +150	$^\circ\text{C}$
ESD	Human Body Model (HBM), JESD22-A114	± 2.0	kV
	Charge Device Model (CDM), JESD22-C101	± 0.5	

Note: 4. These are stress ratings only. Operation outside the absolute maximum ratings can cause device failure. Operation at the absolute maximum rating for extended periods can reduce device reliability.

Package Thermal Data (@ $T_A = +25^\circ\text{C}$, unless otherwise specified.) (Note 5)

Symbol	Parameter	Rating	Unit
P_D	Power Dissipation	1.3	W
$R_{\theta\text{JA}}$	Thermal Resistance, Junction-to-Ambient	96	$^\circ\text{C}/\text{W}$
$R_{\theta\text{JC}}$	Thermal Resistance, Junction-to-Case	26	$^\circ\text{C}/\text{W}$

Note: 5. Device mounted on FR-4 substrate PC board, 2oz copper, with 1" x 1" copper pad layout.

Recommended Operating Conditions (@ $T_A = +25^\circ\text{C}$, unless otherwise specified.)

Symbol	Parameter	Min	Max	Unit
V_{SYS}	Input Supply Voltage at VSYS Pin	2.7	5.5	V
V_{FAULTB}	Power Rail for Pull-up on FAULTB Pin	2.7	5.5	V
$V_{\text{CCxC}}, V_{\text{CCxS}}$	I/O Voltage at CC1C, CC2C, CC1S, CC2S Pins	-0.25	5.5	V
$V_{\text{SBUxC}}, V_{\text{SBUxS}}$	I/O Voltage at SBU1C, SBU2C, SBU1S, SBU2S Pins	-0.25	4.2	V
I_{VCONN}	Output Current Flowing Into CCxS and out of CCxC, with $V_{\text{CCxS}} - V_{\text{CCxC}} \leq 250\text{mV}$	—	600	mA

Electrical Characteristics (@ $T_A = +25^\circ\text{C}$, $V_{\text{SYS}} = 4.2\text{V}$, unless otherwise specified.)

Symbol	Parameter	Test Conditions	Min	Typ	Max	Unit
CC OVP Switches						
R _{DS(ON)_CC}	On Resistance of CC OVP FETs	$V_{\text{CCxC}} = 5.5\text{V}$, $T_A \leq +85^\circ\text{C}$	—	350	500	m Ω
		$V_{\text{CCxC}} = 5.5\text{V}$, $T_A \leq +105^\circ\text{C}$	—	350	520	m Ω
R _{DS(ONFLAT)_CC}	On Resistance Flatness of CC OVP FETs	$V_{\text{CCxC}} = 0.1\text{V}$ to 1.2V	—	—	5	m Ω
CON _{CC}	Equivalent ON Capacitance	Capacitance from CCxC or CCxS to GND when device is powered, ($V_{\text{CCxC}} / V_{\text{CCxS}} = 0\text{V}$ to 1.2V)	—	50	—	pF
R _{PD_CCxC}	Dead Battery Pull-Down Resistance on CCxC Pin	$V_{\text{CCxC}} = 2.6\text{V}$	4.10	5.1	6.10	k Ω
V _{TH_RPD_CCxC}	Threshold Voltage of the Pulldown FET for in Series with R _{PD_CCxC}	$I_{\text{CCxC}} = 100\mu\text{A}$	1.2	1.4	1.6	V
V _{TH_OVP_CCxC}	OVP Threshold on CCxC Signal	—	5.6	6	6.25	V
V _{TH_OVP_HYS_CCxC}	OVP Hysteresis on CCxC Signal	—	—	140	—	mV
BW _{ON_CC} (Note 6)	CC Line ON Bandwidth Single Ended (-3dB)	Measured from CCxC to CCxS, 50 Ω system, $V_{\text{CM}} = 0.1\text{V}$ to 1.2V	—	200	—	MHz
V _{SHT_CCxC_MAX} (Note 6)	Short-to-VBUS Tolerance on the CCxC Pins	Hot-plug CCxC with a 1 meter USB Type-C cable, place a 30 Ω load on CCxS	—	—	22	V
V _{SHT_CCxS_CL} (Note 6)	Short-to-VBUS Clamping Voltage on the CCxS Pins	Hot-plug CCxC with a 1 meter USB Type-C cable, place a 30 Ω load on CCxS. Hot plug voltage $V_{\text{CCxC}} = 24\text{V}$	—	7	—	V
SBU OVP Switches						
R _{DS(ON)_SBU}	On Resistance of SBU OVP FETs	$V_{\text{SBUxC}} = 3.6\text{V}$, $T_A = +85^\circ\text{C}$	—	5	—	Ω
		$V_{\text{SBUxC}} = 3.6\text{V}$, $T_A = +105^\circ\text{C}$	—	5	—	Ω
R _{DS(ONFLAT)_SBU}	On Resistance Flatness of SBU OVP FETs	$V_{\text{SBUxC}} = 0.1\text{V}$ to 3.6V	—	—	1	Ω
CON _{SBU}	Equivalent ON Capacitance	Capacitance from SBUxC or SBUxS to GND when device is powered. $V_{\text{SBUxC}} / V_{\text{SBUxS}} = 0\text{V}$ to 3.6V	—	5	—	pF
V _{TH_OVP_SBUxC}	OVP Threshold on SBUxC Signals	—	4.15	4.5	4.75	V
V _{TH_OVP_HYS_SBUxC}	OVP Hysteresis on SBUxC Signals	—	—	110	—	mV
BW _{ON_SBU} (Note 6)	SBU Line ON Bandwidth Single Ended (-3dB)	Measured from SBUxC to SBUxS, 50 Ω system, $V_{\text{CM}} = 0.1\text{V}$ to 3.6V	—	600	—	MHz
V _{SHTBUS_SBUxC_MAX} (Note 6)	Short-to-VBUS Tolerance on the SBUxC Pins	Hot-plug SBUxC with a 1 meter USB Type-C cable, place a 40 Ω in series with 150nF to GND on SBUxS pin	—	—	22	V
V _{SHTBUS_SBUxS_CL} (Note 6)	Short-to-VBUS Clamping Voltage on the SBUxS Pins	Hot-plug SBUxC with a 1 meter USB Type-C cable, place a 40 Ω in series with 100nF to GND on SBUxS pin. Hot plug voltage $V_{\text{SBUxC}} = 24\text{V}$, $V_{\text{SYS}} = 3.3\text{V}$	—	7	—	V
X _{TALK_SBUx} (Note 6)	Crosstalk between SBUx Lines	Measure crosstalk at $f = 1\text{MHz}$, from SBU1S to SBU2C or SBU2S to SBU1C. $V_{\text{CM1}} = 3.6\text{V}$, $V_{\text{CM2}} = 0.3\text{V}$, terminate open sides to 50 Ω	—	-80	—	dB

Note: 6. Guaranteed by bench characterization.

Electrical Characteristics (@ $T_A = +25^\circ\text{C}$, $V_{VSYS} = 4.2\text{V}$, unless otherwise specified.) (continued)

Symbol	Parameter	Test Conditions	Min	Typ	Max	Unit
Power Supply and Leakage Current						
V_{UVLO}	V_{VSYS} Under Voltage Lockout	V_{VSYS} steps up from 2V until CC or SBU FETs turn ON	2.15	2.4	2.55	V
V_{UVLO_HSYS}	V_{VSYS} UVLO Hysteresis	V_{VSYS} steps down from 2.5V until CC or SBU FETs turn off. Measure difference between rising and falling UVLO to calculate	—	200	—	mV
I_{VSYS_ON}	V_{VSYS} Supply Current	—	—	190	—	μA
I_{LEAK_CCxS}	Leakage current for CCxS when device is Powered	$V_{CCxS} = 3.6\text{V}$	—	—	30	μA
I_{LEAK_SBUxS}	Leakage current for SBUxS when device is Powered	$V_{SBUxS} = 3.6\text{V}$	—	—	35	μA
I_{LEAK_CCxS}	Leakage Current for CCxS when device is Powered	$V_{CCxS} = 3.6\text{V}$	—	—	30	μA
I_{LEAK_SBUxS}	Leakage current for SBUxS when device is Powered	$V_{SBUxS} = 3.6\text{V}$	—	—	35	μA
$I_{LEAK_OVP_CCxS}$	Leakage current into CCxS pins when device is in OVP	$V_{VSYS} = 0\text{V}$, $V_{CCxS} = 21\text{V}$, $V_{CCxS} = 0\text{V}$	—	—	6	mA
		$V_{VSYS} = 4.2\text{V}$, $V_{CCxS} = 21\text{V}$, $V_{CCxS} = 0\text{V}$	—	—	150	μA
$I_{LEAK_OVP_SBUxS}$	Leakage current into SBUxS pins when device is in OVP	$V_{VSYS} = 0\text{V}$, $V_{SBUxS} = 21\text{V}$, $V_{SBUxS} = 0\text{V}$	—	—	200	μA
		$V_{VSYS} = 4.2\text{V}$, $V_{SBUxS} = 21\text{V}$, $V_{SBUxS} = 0\text{V}$	—	—	200	μA
$I_{LEAK_OVP_CCxS}$	Leakage current out of CCxS pins when device is in OVP	$V_{VSYS} = 0\text{V}$, $V_{CCxS} = 21\text{V}$, $V_{CCxS} = 0\text{V}$	—	—	1	μA
		$V_{VSYS} = 4.2\text{V}$, $V_{CCxS} = 21\text{V}$, $V_{CCxS} = 0\text{V}$	—	—	1	μA
$I_{LEAK_OVP_SBUxS}$	Leakage current out of SBUxS pins when device is in OVP	$V_{VSYS} = 0\text{V}$, $V_{SBUxS} = 21\text{V}$, $V_{SBUxS} = 0\text{V}$	—	—	1	μA
		$V_{VSYS} = 4.2\text{V}$, $V_{SBUxS} = 21\text{V}$, $V_{SBUxS} = 0\text{V}$	—	—	1	μA
FAULTB Pin						
V_{FAULTB}	Active-Low Output Voltage of FAULTB Pin	$I_{OL} = 8\text{mA}$	—	—	0.4	V
I_{LEAK_FAULTB}	FAULTB Leakage Current	$V_{FAULTB} = 4.2\text{V}$	—	—	1	μA
$t_{FAULTB_ASSERTION}$	FAULTB Assertion Time	—	—	—	300	μs
$t_{FAULTB_DEASSERTION}$	FAULTB Deassertion Time	—	—	4	—	ms
Timing Requirements						
t_{ON}	Time from crossing rising V_{VSYS} UVLO until CC/SBU OVP FETs are on	—	—	—	2.5	ms
$t_{OVP_RESPONSE_CC}$	OVP response time on the CC pins, time from OVP asserted until OVP FETs turnoff	—	—	100	—	ns
$t_{OVP_RESPONSE_SBU}$	OVP response time on the SBU pins, time from OVP asserted until OVP FETs turnoff	—	—	100	—	ns
$t_{OVP_RESPONSE_CC_1}$	OVP recovery time on the CC pins. Once an OVP has occurred, the minimum duration until CC FETs turn back on if OVP has been removed already	—	26	32	38	ms
$t_{OVP_RESPONSE_SBU_1}$	OVP recovery time on the SBU pins. Once an OVP has occurred, the minimum duration until SBU FETs turn back on if OVP has been removed already	—	26	32	38	ms
$t_{OVP_RESPONSE_CC_2}$	OVP recovery time on the CC pins. Time from OVP removal until CC FETs turn back on, if device has been in OVP > 40ms	—	—	1	—	ms
$t_{OVP_RESPONSE_SBU_2}$	OVP recovery time on the SBU pins. Time from OVP removal until SBU FETs turn back on, if device has been in OVP > 40ms	—	—	1	—	ms
Thermal Shutdown and Hysteresis						
T_{SHDN}	Thermal Shut Down Theshold	—	—	+150	—	$^\circ\text{C}$
T_{HSYS}	Thermal Shut Down Hysteresis	—	—	+20	—	$^\circ\text{C}$

Performance Characteristics (@ $T_A = +25^\circ\text{C}$, unless otherwise specified.)

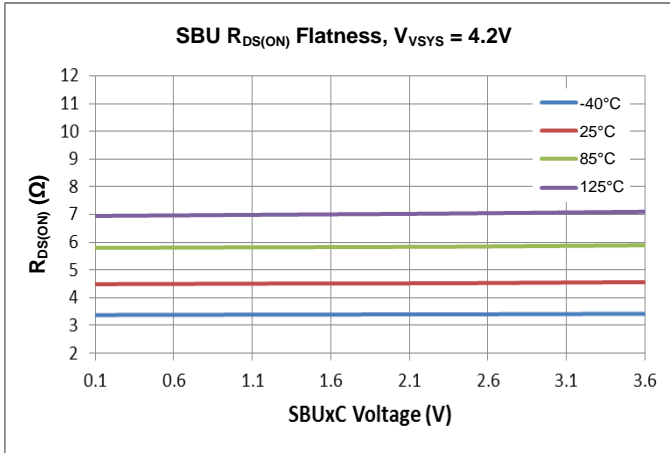

Figure 3. SBU $R_{DS(ON)}$ Flatness

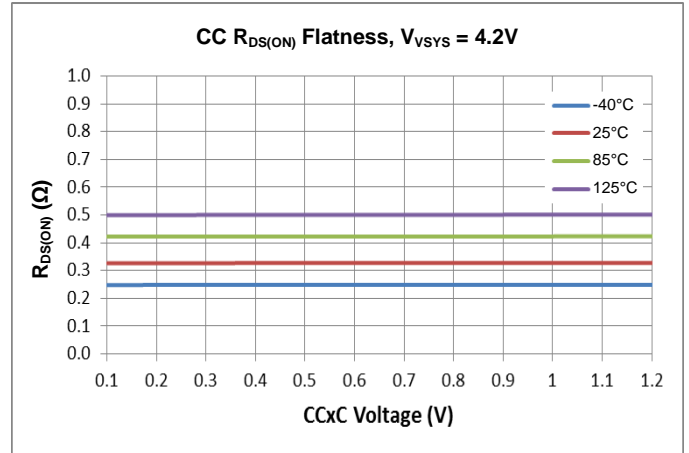

Figure 4. CC $R_{DS(ON)}$ Flatness

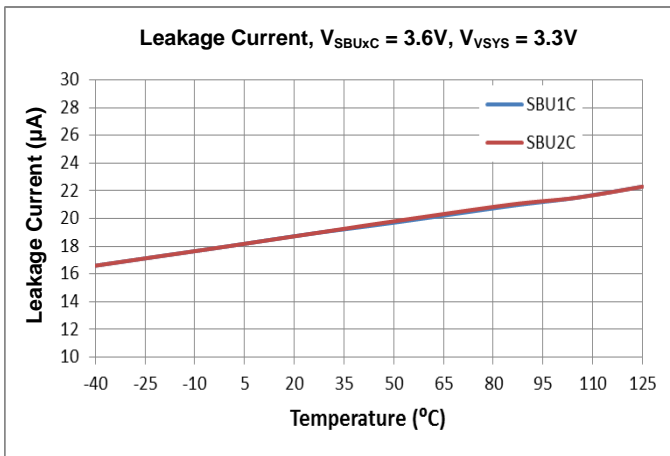

Figure 5. SBUx Leakage Current vs. Temperature

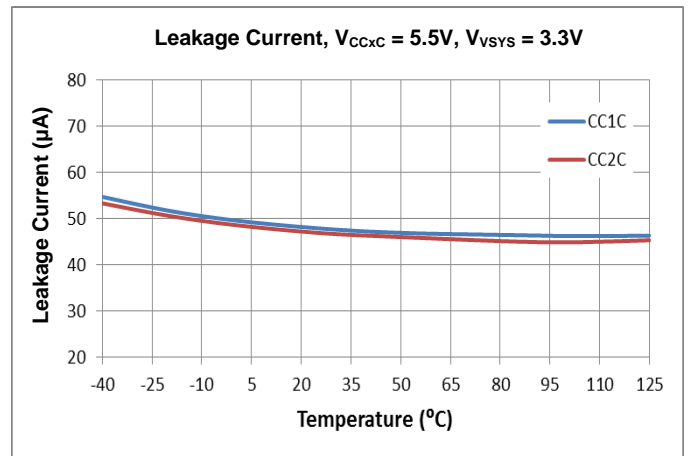

Figure 6. CCx Leakage Current vs. Temperature

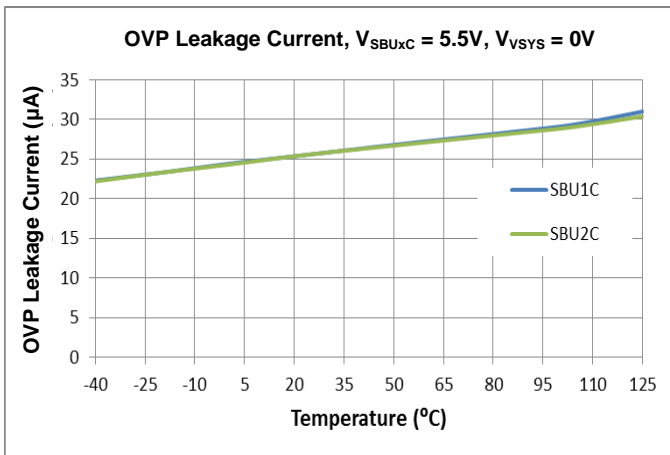

Figure 7. SBUx 5.5V OVP Leakage Current vs. Temperature

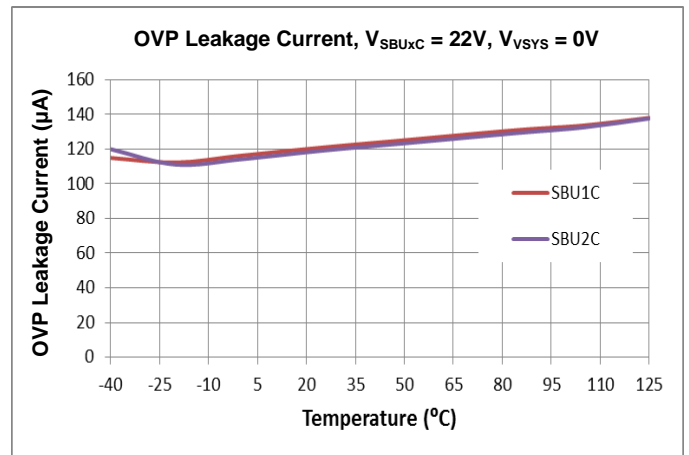

Figure 8. SBUx 22V OVP Leakage Current vs. Temperature

Performance Characteristics (@ $T_A = +25^\circ\text{C}$, unless otherwise specified.) (continued)

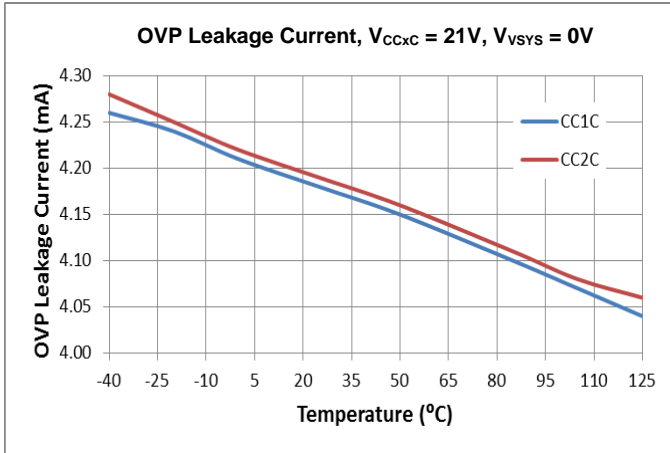

Figure 9. CCxOVP Leakage Current vs. Temperature

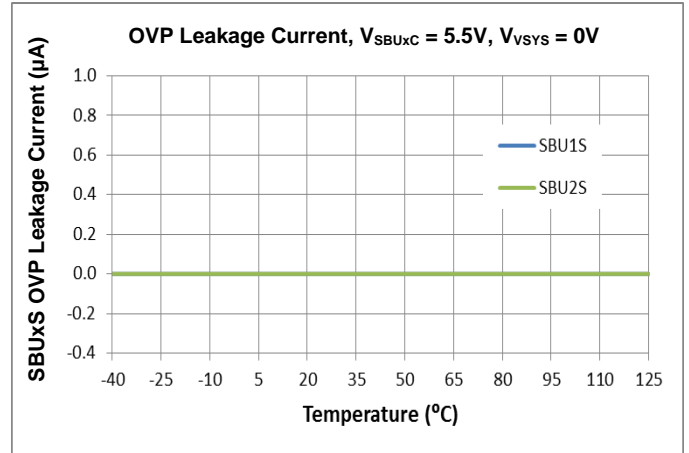

Figure 10. SBUxS OVP Leakage Current vs. Temperature

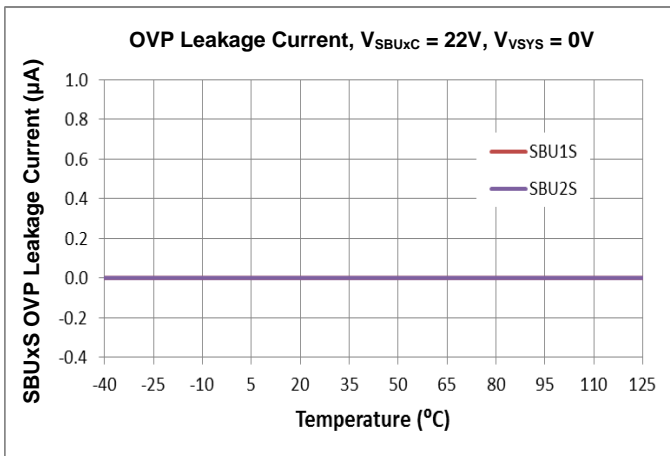

Figure 11. SBUxS OVP Leakage Current vs. Temperature

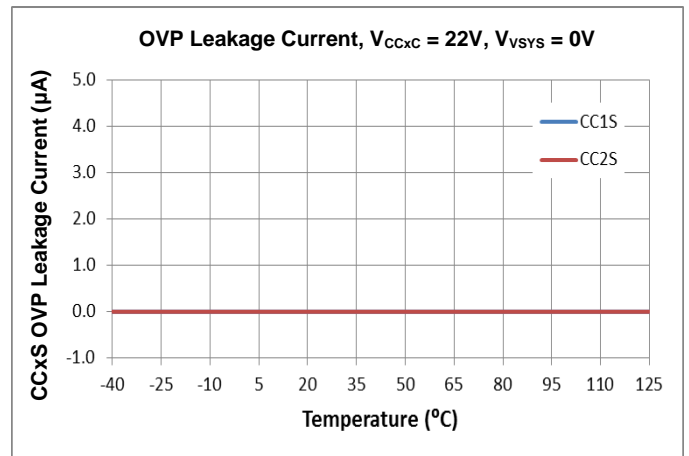

Figure 12. CCxS OVP Leakage Current vs. Temperature

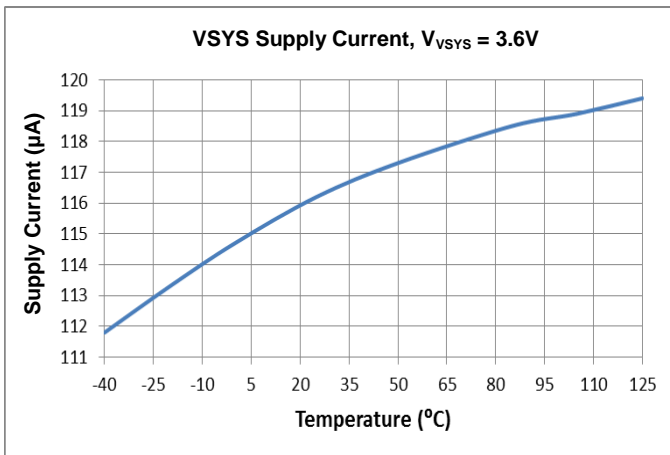

Figure 13. VSYS Supply Current vs Temperature

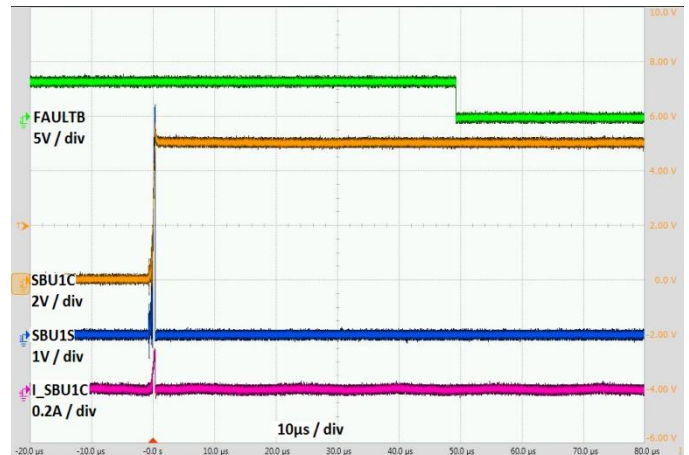

Figure 14. SBU1C Short to 5V V_{BUS}

Performance Characteristics (@ $T_A = +25^\circ\text{C}$, unless otherwise specified.) (continued)

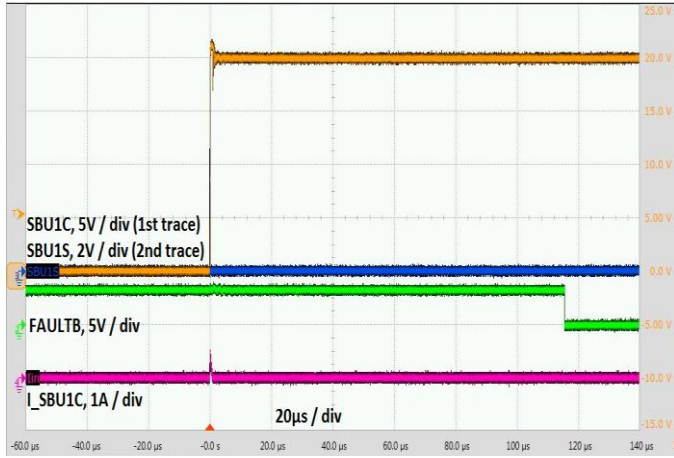

Figure 15. SBU1C Short to 20V V_{BUS}

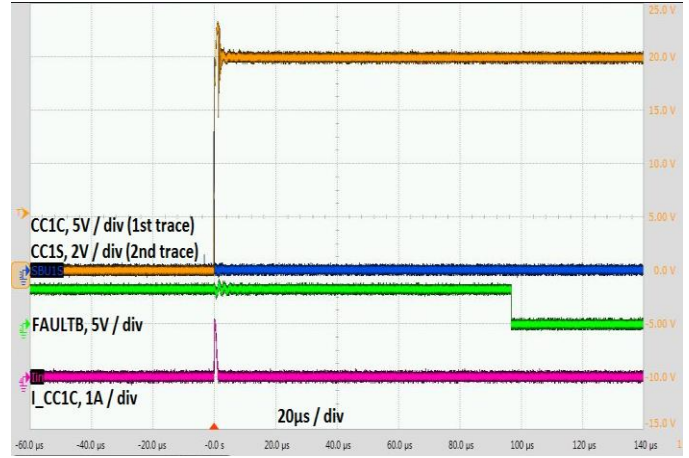

Figure 16. CC1C Short to 20V V_{BUS}



Figure 17. SBU MOSFET Turn-On Time

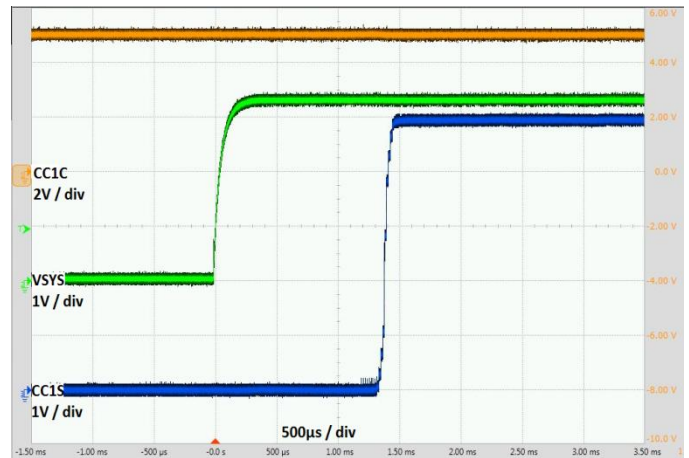

Figure 18. CC MOSFET Turn-On Time

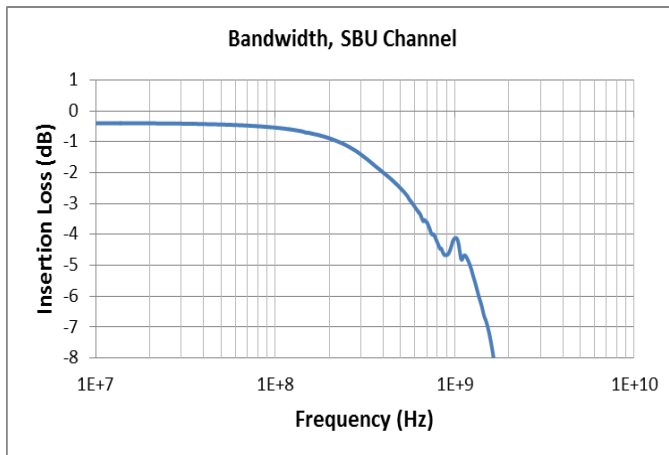

Figure 19. SBU Channel Bandwidth

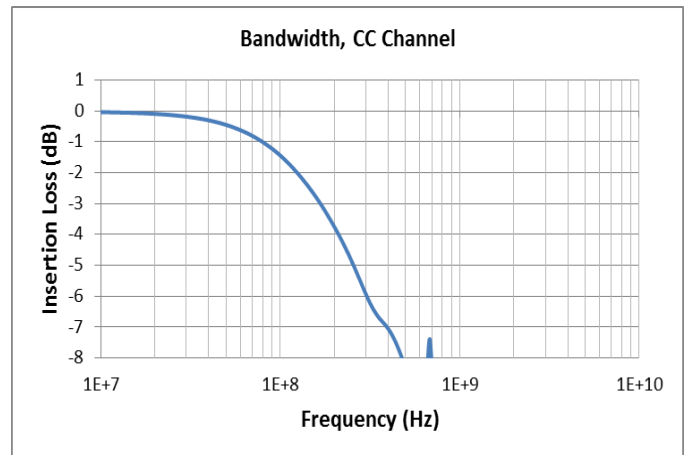

Figure 20. CC Channel Bandwidth

Performance Characteristics (@ $T_A = +25^\circ\text{C}$, unless otherwise specified.) (continued)

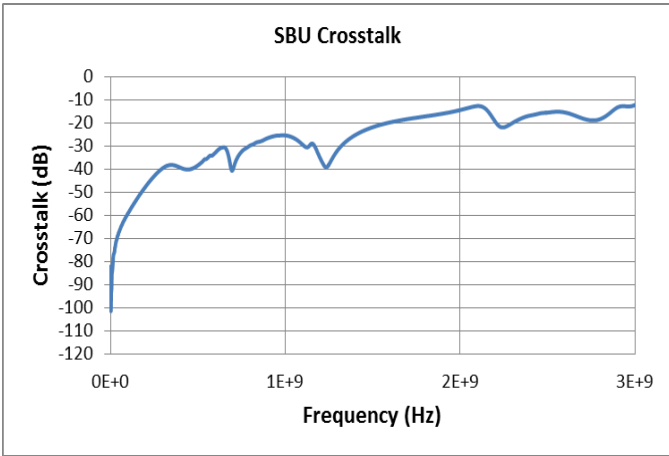

Figure 21. SBU Crosstalk

Application Information

General Description

The DPO2036 is a USB port protection device designed to work with USB Type-C connector, cable and USB PD to form a system that enables signal management and power delivery in a compact package. It provides short to VBUS protection for the CC and SBU pins over the USB Type-C connector, and supports the dead battery mode of operation in an end system / product where the embedded battery is fully depleted.

Short to VBUS Protection

The DPO2036 is a 4-channel uni-directional power switch with over-voltage protection. This is used to prevent the components inside a system which adopts the USB Type-C connector from being damaged by unexpected hazard. On the USB Type-C connector, the CC and SBU pins are located in the close proximity of the VBUS pin. If ever the CC and/or the SBU lines are short to the VBUS line either at the USB-C connector or at the cable end, the components (mostly ICs manufactured on the various sub-micron process nodes) behind the USB Type-C connector can easily be damaged by the resulting EOS. The damage, if occurred, is likely non-recoverable especially given that the voltage level on the VBUS line can go up to 20V or slightly higher. The DPO2036 integrates four series over-voltage FETs to protect the system side CC and SBU lines. When either line on the Type-C connector side CC1C, CC2C, SBU1C or SBU2C is shorted to VBUS line, the DPO2036 will turn off the over-voltage FETs in less than 100ns window to isolate the system side CC and SBU lines from the over-voltage connector side. When shorted to VBUS line is detected, the open-drain FAULTB will output low to indicate a fault condition.

Dead Battery Charging and Power Delivery

In a battery-powered system, the pull-down resistors embedded inside DPO2036 are turned ON and connected to the CC1C/CC2C pins whenever the battery is depleted. Subsequently, the battery-powered system shall receive power through the USB Type-C connector from the external device connected. As soon as the embedded battery is sufficiently recharged to power the system and DPO2036, the pull-down resistors shall be disconnected from the CC1C/CC2C pins.

Signal Operation Range

Table 1 and Table 2 show the signal operation range and output status:

0V to UVLO (Invalid)	0V to 5.85V	OFF: Dead Battery R _{PD} Inserted
	5.85V to 20V	OFF: Dead Battery R _{PD} Inserted
2.7V to 5.5V (Valid)	0V to 5.85V	ON
	5.85V to 20V	OFF: FAULTB Asserted (OVP detected)

Table 1. Signal Operation Range for CCx

0V to UVLO (Invalid)	0V to 4.35V	OFF
	4.35V to 20V	OFF
2.7V to 5.5V (Valid)	0V to 4.35V	ON
	4.35V to 20V	OFF: FAULTB Asserted (OVP detected)

Table 2. Signal Operation Range for SBUx

Ordering Information (Note 7)

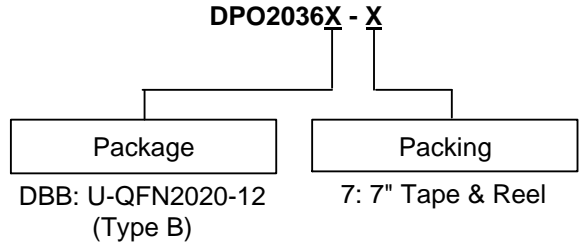

Part Number	Marking ID	Reel Size (inches)	Tape Width (mm)	7" Tape and Reel	
				Quantity	Part Number Suffix
DPO2036DBB-7	PO36	7	8	3,000/Tape & Reel	-7

Note: 7. For packaging details, go to our website at <https://www.diodes.com/design/support/packaging/diodes-packaging/>.

Marking Information

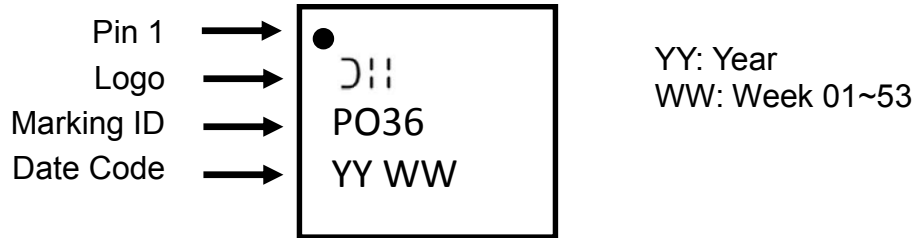

Package Outline Dimensions

Please see <http://www.diodes.com/package-outlines.html> for the latest version.

U-QFN2020-12 (Type B)

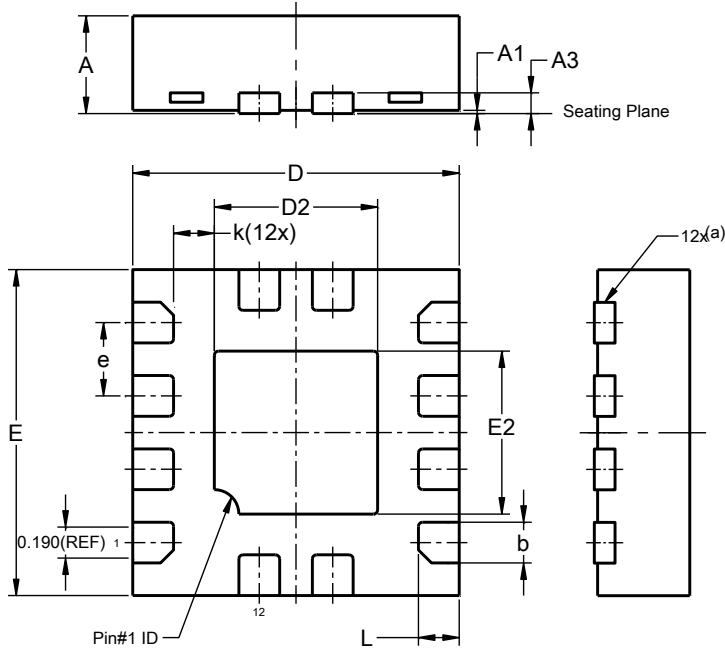

U-QFN2020-12 (Type B)			
Dim	Min	Max	Typ
A	0.55	0.65	0.60
A1	0.00	0.05	0.02
A3	--	--	0.13
b	0.20	0.30	0.25
D	1.95	2.05	2.00
D2	0.90	1.10	1.00
E	1.95	2.05	2.00
E2	0.90	1.10	1.00
e	0.45 BSC		
k	--	--	0.25
L	0.20	0.30	0.25
All Dimensions in mm			

a) Actual shape depending upon manufacturing technology used.

Suggested Pad Layout

Please see <http://www.diodes.com/package-outlines.html> for the latest version.

U-QFN2020-12 (Type B)

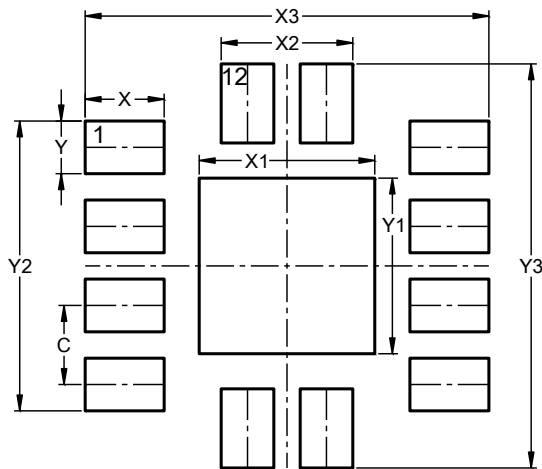

Dimensions	Value (in mm)
C	0.450
X	0.450
X1	1.000
X2	0.750
X3	2.300
Y	0.300
Y1	1.000
Y2	1.650
Y3	2.300

Mechanical Data

- Moisture Sensitivity: Level 1 per J-STD-020
- Terminals: NiPdAu Finish, Solderable per MIL-STD-202, Method 208④
- Weight: 0.007 grams (Approximate)

IMPORTANT NOTICE

DIODES INCORPORATED MAKES NO WARRANTY OF ANY KIND, EXPRESS OR IMPLIED, WITH REGARDS TO THIS DOCUMENT, INCLUDING, BUT NOT LIMITED TO, THE IMPLIED WARRANTIES OF MERCHANTABILITY AND FITNESS FOR A PARTICULAR PURPOSE (AND THEIR EQUIVALENTS UNDER THE LAWS OF ANY JURISDICTION).

Diodes Incorporated and its subsidiaries reserve the right to make modifications, enhancements, improvements, corrections or other changes without further notice to this document and any product described herein. Diodes Incorporated does not assume any liability arising out of the application or use of this document or any product described herein; neither does Diodes Incorporated convey any license under its patent or trademark rights, nor the rights of others. Any Customer or user of this document or products described herein in such applications shall assume all risks of such use and will agree to hold Diodes Incorporated and all the companies whose products are represented on Diodes Incorporated website, harmless against all damages.

Diodes Incorporated does not warrant or accept any liability whatsoever in respect of any products purchased through unauthorized sales channel. Should Customers purchase or use Diodes Incorporated products for any unintended or unauthorized application, Customers shall indemnify and hold Diodes Incorporated and its representatives harmless against all claims, damages, expenses, and attorney fees arising out of, directly or indirectly, any claim of personal injury or death associated with such unintended or unauthorized application.

Products described herein may be covered by one or more United States, international or foreign patents pending. Product names and markings noted herein may also be covered by one or more United States, international or foreign trademarks.

This document is written in English but may be translated into multiple languages for reference. Only the English version of this document is the final and determinative format released by Diodes Incorporated.

LIFE SUPPORT

Diodes Incorporated products are specifically not authorized for use as critical components in life support devices or systems without the express written approval of the Chief Executive Officer of Diodes Incorporated. As used herein:

A. Life support devices or systems are devices or systems which:

1. are intended to implant into the body, or
2. support or sustain life and whose failure to perform when properly used in accordance with instructions for use provided in the labeling can be reasonably expected to result in significant injury to the user.

B. A critical component is any component in a life support device or system whose failure to perform can be reasonably expected to cause the failure of the life support device or to affect its safety or effectiveness.

Customers represent that they have all necessary expertise in the safety and regulatory ramifications of their life support devices or systems, and acknowledge and agree that they are solely responsible for all legal, regulatory and safety-related requirements concerning their products and any use of Diodes Incorporated products in such safety-critical, life support devices or systems, notwithstanding any devices- or systems-related information or support that may be provided by Diodes Incorporated. Further, Customers must fully indemnify Diodes Incorporated and its representatives against any damages arising out of the use of Diodes Incorporated products in such safety-critical, life support devices or systems.

Copyright © 2020, Diodes Incorporated

www.diodes.com

单击下面可查看定价，库存，交付和生命周期等信息

[>>Diodes Incorporated\(达达科技\(美台\)\)](#)