



A Product Line of  
Diodes Incorporated



## SPECIFICATION FOR APPROVAL

CUSTOMER \_\_\_\_\_

NOMINAL FREQUENCY 50.000000 MHz

HOLDER TYPE TYPE FK 3.2x2.5 SEAM SEALED CRYSTAL CLOCK OSCILLATOR

SPEC. NO. ( P/N ) FK5000039

CUSTOMER P/N \_\_\_\_\_

ISSUE DATE May 30, 2018

VERSION B

APPROVED	PREPARED	QA
<i>Brenda Kuo</i>	<i>Winnie Chang</i>	<i>Dony Yang</i>

### Diodes Incorporated

No.2, Ziqiang 5th Rd., Zhongli Industrial Park,  
Zhongli Dist., Taoyuan City 32063, Taiwan (R.O.C.)  
TEL: 886-3-451-8888  
FAX: 886-3-461-3865  
<https://www.diodes.com>

\*Pb-free  
\*RoHS Compliant  
\*HF-Halogen Free  
\*REACH Compliant

# TYPE FK 3.2x2.5 SEAM SEALED CRYSTAL CLOCK OSCILLATOR

***FK5000039***

VER. B 30-May-18

## VERSION HISTORY

Version No.	Version Date	Description	Notes
A	Mar.24,2015	Initial Release	
B	May.30,2018	Updated Logo	



# TYPE FK 3.2x2.5 SEAM SEALED CRYSTAL CLOCK OSCILLATOR

## FK5000039

VER. B 30-May-18

### ELECTRICAL SPECIFICATIONS

SRe Part Number : FK5000039

Item	Symbol	Specifications	Units	Notes
Nominal Frequency	F <sub>0</sub>	50.000000	MHz	
Frequency Stability	FT	± 25	ppm	**See note
Operating Temperature Range	TR	-40 to +85	°C	
Supply Voltage	V <sub>DD</sub>	+1.7 to +3.6	V	at +2.8V Typ.
Logic Type	LT	LVC MOS		
Supply Current, Output Enabled	I <sub>DD</sub> /OE	10	mA	Max.
Supply Current, Output Disabled	I <sub>DD</sub> /OD	10	µA	Max.
Duty Cycle (Symmetry)	DC/SY	45 / 55	%	Measured 50% of Waveform
Rise / Fall Time	T <sub>R</sub> /T <sub>F</sub>	5	ns	Max. measured 10/90% of Waveform
Output Voltage "0" Level	V <sub>OL</sub>	10% V <sub>DD</sub>	V	Max at I <sub>OL</sub> = 4.0mA Min.
Output Voltage "1" Level	V <sub>OH</sub>	90% V <sub>DD</sub>	V	Min at I <sub>OH</sub> = -4.0mA Max.
Output Load	CL	15	pF	Max
Jitter, Phase	RMS	1	ps	Max. 12KHz ~ 20MHz Frequency Band
Jitter, Accumulated	RMS(1-σ)	3	ps	Typ. 20,000 Consecutive Periods
Jitter, Peak to Peak	Pk-Pk	30	ps	Max. 100,000 Random Periods
Start Up Time		10	ms	Max.
Storage Temperature Range		-55 to +125	°C	

※ This product doesn't include harmful substance that stipulated by SONY SS-00259 Level 1 and S-AT2-001 Level 1 standard. RoHS Compliant (Pb - Free).

\*\*Stability includes all combinations of Operating Temperature, Load changes, rated Input (Supply) Voltage changes, Initial Calibration Tolerance (25°C), Aging (1 year at 25°C Average Effective Ambient Temperature), Shock and Vibration.

#### Output Enable / Disable Function

Parameter	Min.	Typ.	Max.	Units	Notes
Input Voltage (Pin1), Output Enable	0.7V <sub>DD</sub>			V	Or Open
Input Voltage (Pin1), Output Disable (low power standby)			0.3V <sub>DD</sub>	V	Output is Hi-Z
Internal Pullup Resistance	30			KΩ	
Output Disable Delay			50	ns	

# TYPE FK 3.2x2.5 SEAM SEALED CRYSTAL CLOCK OSCILLATOR

**FK5000039**

VER. B 30-May-18

## TEST CIRCUIT

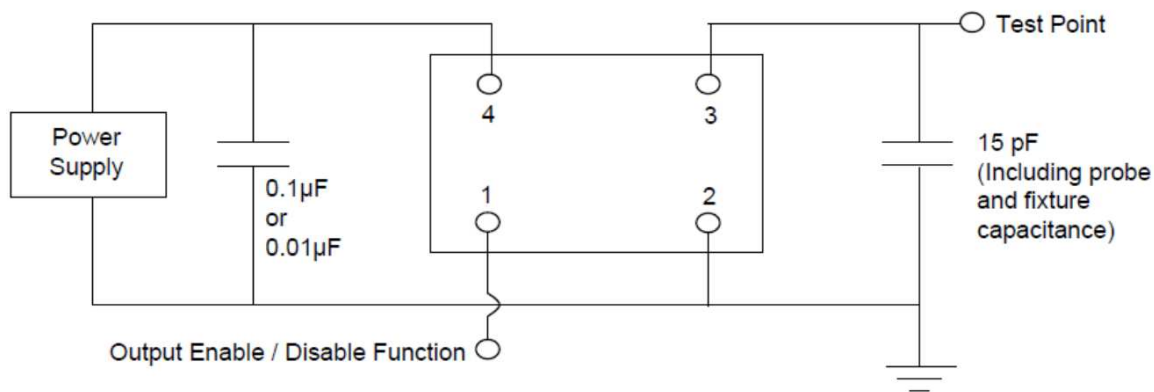

## OUTPUT WAVEFORM

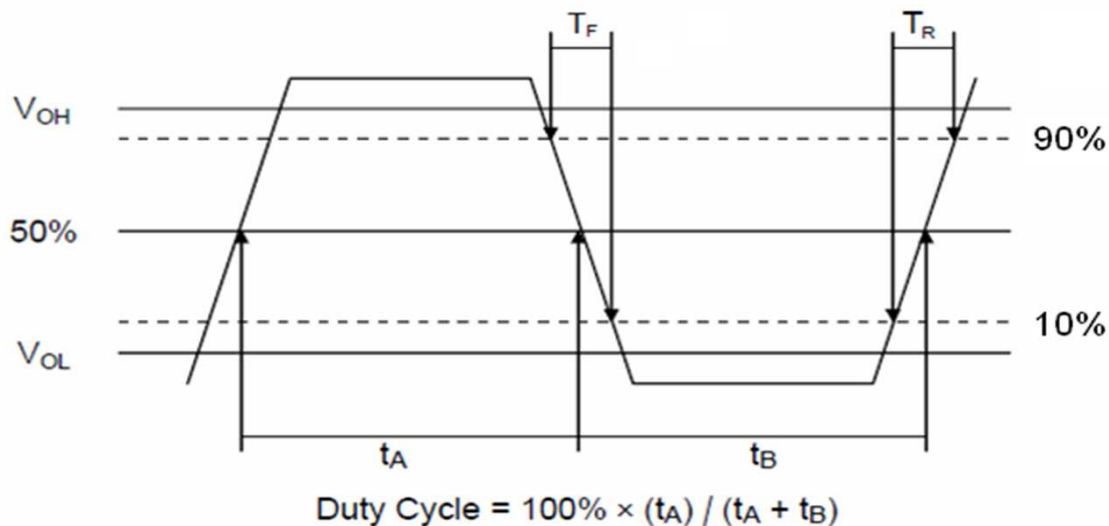

# TYPE FK 3.2x2.5 SEAM SEALED CRYSTAL CLOCK OSCILLATOR

**FK5000039**

VER. B 30-May-18

## RELIABILITY SPECIFICATIONS

### ENVIRONMENTAL:

- a) THERMAL SHOCK: MIL-STD-883, Method 1011, Condition A
- b) MOISTURE RESISTANCE: MIL-STD-883, Method 1004
- c) VIBRATION: MIL-STD-883, Method 2007, Condition A
- d) RESISTANCE TO SOLDERING HEAT: J-STD-020D Table 5-2 Pb-free devices (except 2 cycles max)
- e) HAZARDOUS SUBSTANCE: Pb - free and RoHS Compliant.

### MECHANICAL:

- a) SHOCK: MIL-STD-883, Method 2002, Condition B
- b) SOLDERABILITY: JESD22-B102-D Method 2 (Preconditioning E)
- c) TERMINAL STRENGTH: MIL-STD-883, Method 2004, Test Condition D
- d) GROSS LEAK: MIL-STD-883, Method 1014, Condition C
- e) FINE LEAK: MIL-STD-883, Method 1014, Condition A2,  $R1=2 \times 10^{-8}$  atm cc/s
- f) SOLVENT RESISTANCE: MIL-STD-202, Method 215

## SUGGESTED IR REFLOW PROFILE

\*As per IPC-JEDEC J-STD-020D

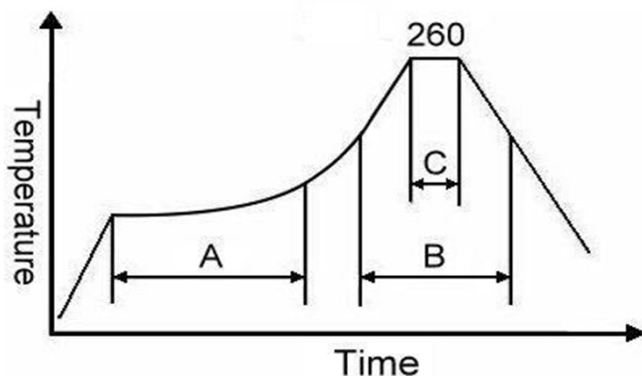

Note:

	Stage	Temperature	Time
A	Preheat	150~200°C	60~120 Sec
B	Primary Heat	217°C	60~150 Sec
C	Peak	260°C	10 Sec

# TYPE FK 3.2x2.5 SEAM SEALED CRYSTAL CLOCK OSCILLATOR

**FK5000039**

VER. B 30-May-18

## MARKING

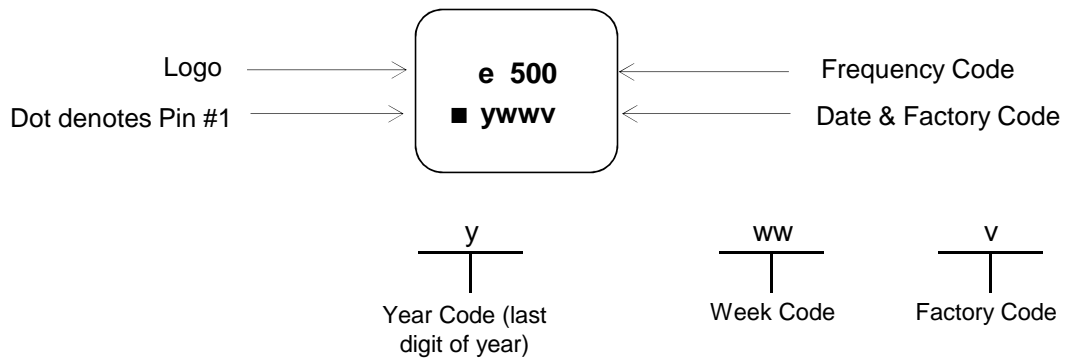

## MECHANICAL DRAWINGS ( Scale:None. Dimensions are in mm.)

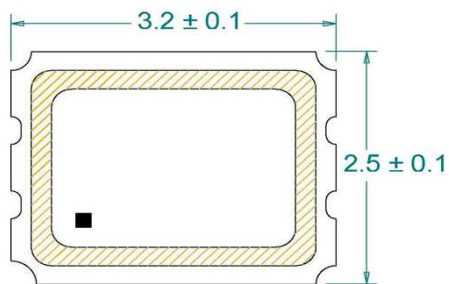

(Bottom View)

### Recommended Land Pattern\*



\*External high-frequency power decoupling is recommended. (see test circuit for minimum recommendation). To ensure optimal performance, do not route traces beneath the package.

Pin	Function
1	OE
2	Ground
3	Clock Output
4	V <sub>DD</sub>

# TYPE FK 3.2x2.5 SEAM SEALED CRYSTAL CLOCK OSCILLATOR

**FK5000039**

VER. B 30-May-18

## TAPE&REEL

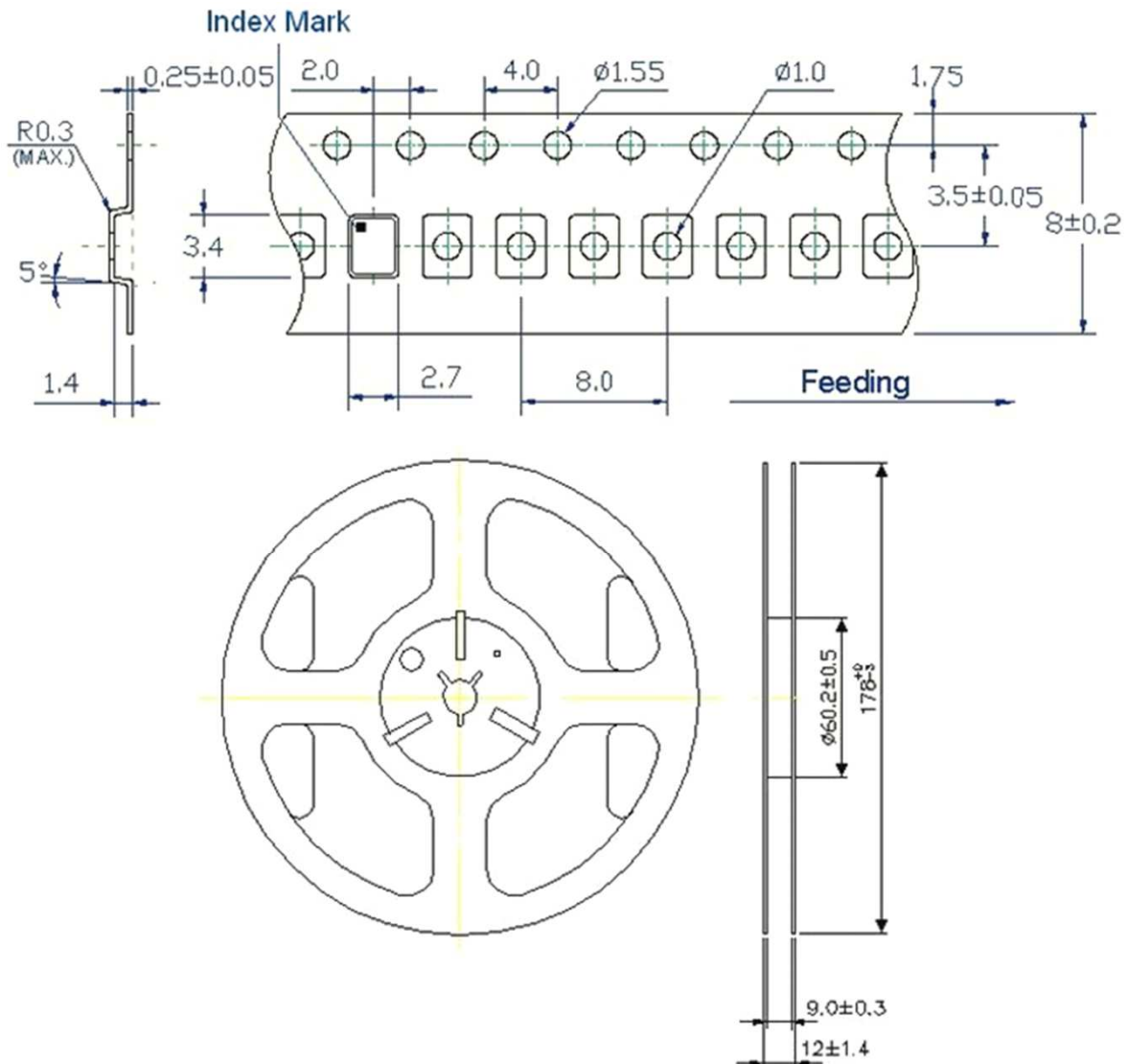

1. 230mm minimum leader which consist of carrier and/or tape followed by a minimum of 160mm of empty carrier tape sealed with cover tape.
2. 160mm minimum trailer of empty carrier tape sealed with cover tape.

# TYPE FK 3.2x2.5 SEAM SEALED CRYSTAL CLOCK OSCILLATOR

**FK5000039**

VER. B 30-May-18

## PACKING

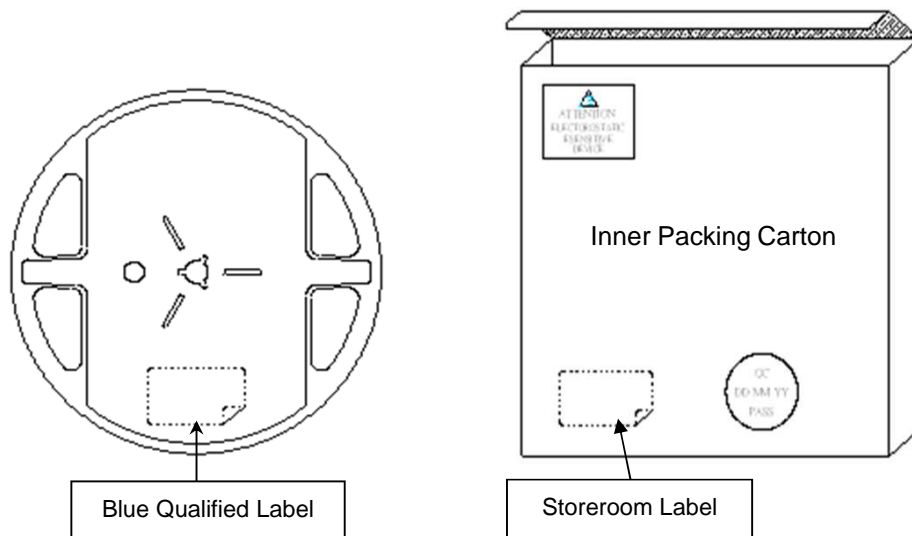



单击下面可查看定价，库存，交付和生命周期等信息

[>>Diodes Incorporated\(达达科技\(美台\)\)](#)