

**Features**

- Glass Passivated Die Construction
- High Case Dielectric Strength of 2500V<sub>RMS</sub>
- Low Reverse Leakage Current
- Surge Overload Rating to 350A Peak
- Ideal for Printed Circuit Board Applications
- UL Listed Under Recognized Component Index, File Number E94661
- **Lead Free Finish; RoHS Compliant (Notes 1 & 2)**

**Mechanical Data**

- Case: GBJ
- Case Material: Molded Plastic.  
UL Flammability Classification 94V-0
- Moisture Sensitivity: Level 1 per J-STD-020
- Terminals: Plated Leads, Solderable per MIL-STD-202, Method 208 **Ⓜ**
- Lead Free Plating (Tin Finish).
- Polarity: Molded on Body
- Mounting: Through Hole for #6 Screw
- Mounting Torque: 5.0 in-lbs Maximum
- Marking: Type Number
- Weight: 6.6 grams (Approximate)

**Marking Information**

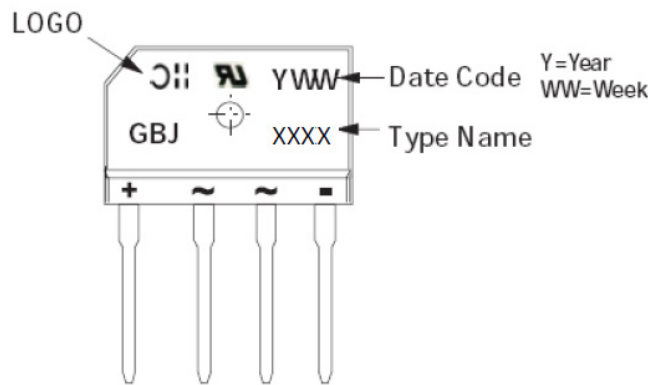

Notes: 1. EU Directive 2002/95/EC (RoHS), 2011/65/EU (RoHS 2) & 2015/863/EU (RoHS 3).compliant. All applicable RoHS exemptions applied.  
2. See <https://www.diodes.com/quality/lead-free/> for more information about Diodes Incorporated's definitions of Halogen- and Antimony-free, "Green" and Lead-free.

### Maximum Ratings (@T<sub>A</sub> = 25°C, unless otherwise specified.)

Single phase, half wave, 60Hz, resistive or inductive load.  
For capacitance load, derate current by 20%.

Characteristic	Symbol	GBJ 25005	GBJ 2501	GBJ 2502	GBJ 2504	GBJ 2506	GBJ 2508	GBJ 2510	Unit
Peak Repetitive Reverse Voltage Working Peak Reverse Voltage DC Blocking Voltage	V <sub>RRM</sub> V <sub>RWM</sub> V <sub>R</sub>	50	100	200	400	600	800	1000	V
RMS Reverse Voltage	V <sub>R(RMS)</sub>	35	70	140	280	420	560	700	V
Average Forward Rectified Output Current (Note 3) @ T <sub>C</sub> = 100°C	I <sub>O</sub>	25							A
Non-Repetitive Peak Forward Surge Current 8.3 ms Single Half Sine-Wave Superimposed on rated Load	I <sub>FSM</sub>	350							A

### Thermal Characteristics

Characteristic	Symbol	Value	Unit
Typical Thermal Resistance Junction to Case (Note 5)	R <sub>θJC</sub>	1.0	°C/W
Operating and Storage Temperature Range	T <sub>J</sub> , T <sub>STG</sub>	-65 to +150	°C

### Electrical Characteristics (@T<sub>A</sub> = 25°C, unless otherwise specified.)

Characteristic	Symbol	Value	Unit
Forward Voltage (per element) @ I <sub>F</sub> = 12.5A	V <sub>FM</sub>	1.05	V
Peak Reverse Current @ T <sub>C</sub> = 25°C at Rated DC Blocking Voltage @ T <sub>C</sub> = 125°C	I <sub>R</sub>	10 500	μA
I <sup>2</sup> t Rating for Fusing (t > 1ms and < 8.3 ms) (Note 3)	I <sup>2</sup> t	510	A <sup>2</sup> s
Typical Total Capacitance (per element) (Note 4)	C <sub>T</sub>	85	pF

- Notes:
3. Non-repetitive, for t > 1ms and < 8.3 ms.
  4. Measured at 1.0 MHz and applied reverse voltage of 4.0V DC.
  5. Thermal resistance from junction to case per element. Unit mounted on 250 x 250 x 20mm aluminum plate heat sink.

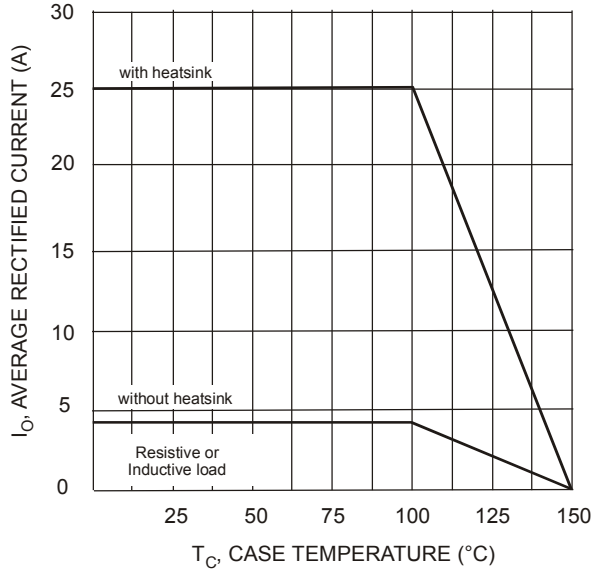

Fig. 1 Forward Current Derating Curve

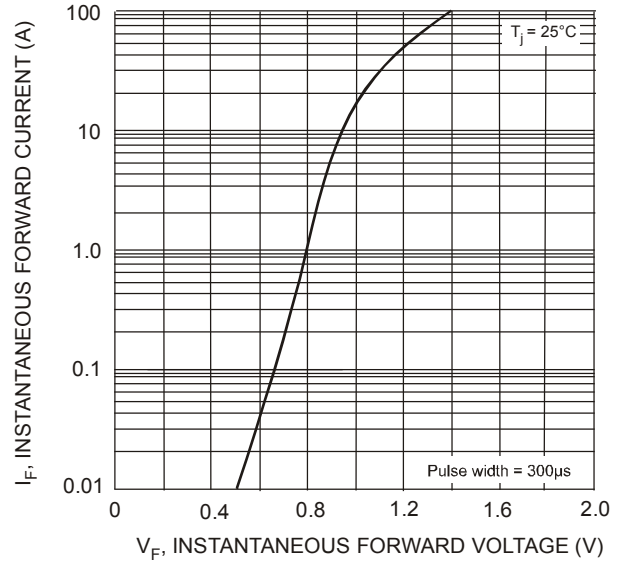

Fig. 2 Typical Forward Characteristics (per element)

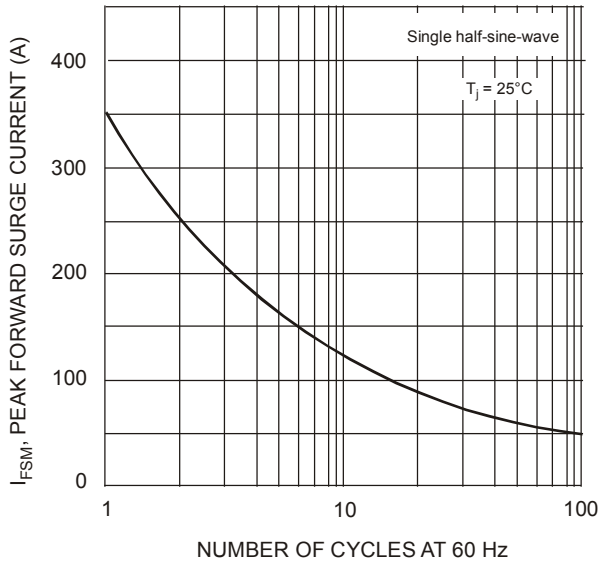

Fig. 3 Maximum Non-Repetitive Surge Current

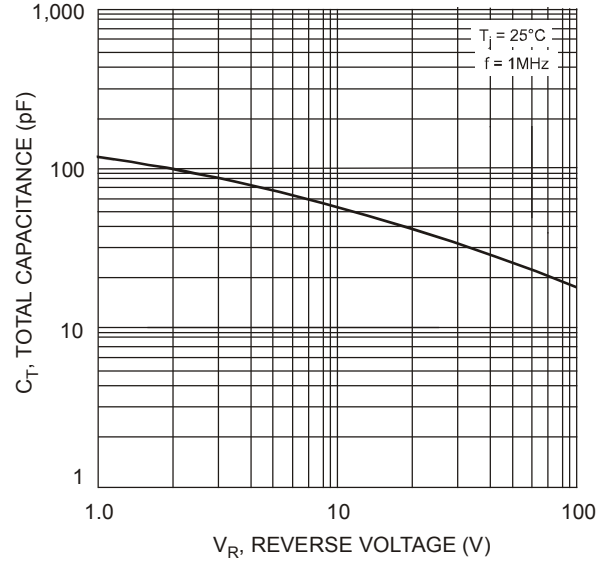

Fig. 4 Typical Total Capacitance, Per Element

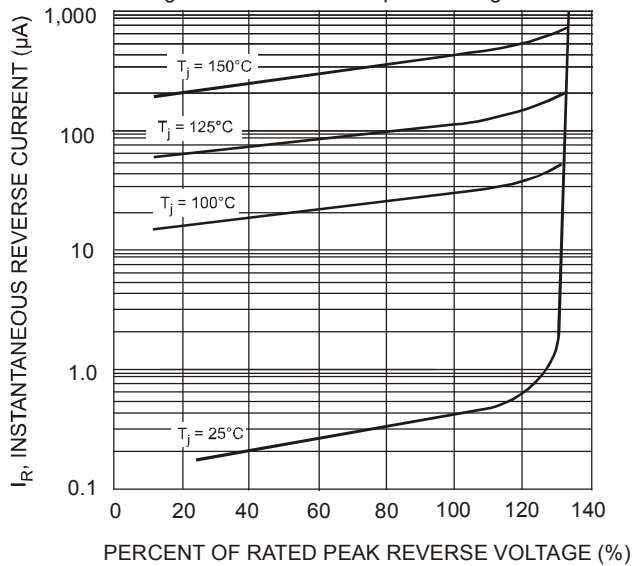

Fig. 5 Typical Reverse Characteristics

**Ordering Information** (Note 6)

Part Number	Case	Packaging
GBJ25005-F	GBJ	15/Tube
GBJ2501-F	GBJ	15/Tube
GBJ2502-F	GBJ	15/Tube
GBJ2504-F	GBJ	15/Tube
GBJ2506-F	GBJ	15/Tube
GBJ2508-F	GBJ	15/Tube
GBJ2510-F	GBJ	15/Tube

Note: 6. For packaging details, go to our website at <http://www.diodes.com/datasheets/ap02007.pdf>.

**Package Outline Dimensions**

Please see <http://www.diodes.com/package-outlines.html> for the latest version.

**GBJ**

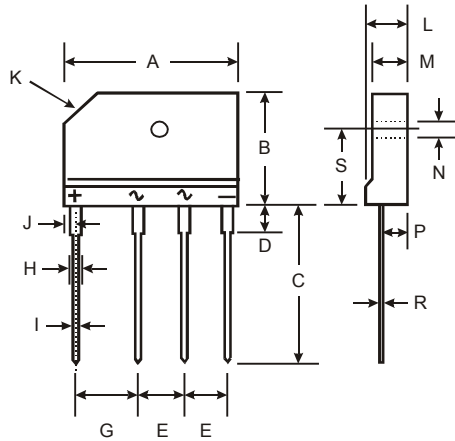

GBJ		
Dim	Min	Max
A	29.70	30.30
B	19.70	20.30
C	17.00	18.00
D	3.80	4.20
E	7.30	7.70
G	9.80	10.20
H	2.00	2.40
I	0.90	1.10
J	2.30	2.70
K	3.0 X 45°	
L	4.40	4.80
M	3.40	3.80
N	3.10	3.40
P	2.50	2.90
R	0.60	0.80
S	10.80	11.20
<b>All Dimensions in mm</b>		

Note: For high voltage applications, the appropriate industry sector guidelines should be considered with regards to creepage and clearance.

**IMPORTANT NOTICE**

DIODES INCORPORATED MAKES NO WARRANTY OF ANY KIND, EXPRESS OR IMPLIED, WITH REGARDS TO THIS DOCUMENT, INCLUDING, BUT NOT LIMITED TO, THE IMPLIED WARRANTIES OF MERCHANTABILITY AND FITNESS FOR A PARTICULAR PURPOSE (AND THEIR EQUIVALENTS UNDER THE LAWS OF ANY JURISDICTION).

Diodes Incorporated and its subsidiaries reserve the right to make modifications, enhancements, improvements, corrections or other changes without further notice to this document and any product described herein. Diodes Incorporated does not assume any liability arising out of the application or use of this document or any product described herein; neither does Diodes Incorporated convey any license under its patent or trademark rights, nor the rights of others. Any Customer or user of this document or products described herein in such applications shall assume all risks of such use and will agree to hold Diodes Incorporated and all the companies whose products are represented on Diodes Incorporated website, harmless against all damages.

Diodes Incorporated does not warrant or accept any liability whatsoever in respect of any products purchased through unauthorized sales channel. Should Customers purchase or use Diodes Incorporated products for any unintended or unauthorized application, Customers shall indemnify and hold Diodes Incorporated and its representatives harmless against all claims, damages, expenses, and attorney fees arising out of, directly or indirectly, any claim of personal injury or death associated with such unintended or unauthorized application.

Products described herein may be covered by one or more United States, international or foreign patents pending. Product names and markings noted herein may also be covered by one or more United States, international or foreign trademarks.

This document is written in English but may be translated into multiple languages for reference. Only the English version of this document is the final and determinative format released by Diodes Incorporated.

**LIFE SUPPORT**

Diodes Incorporated products are specifically not authorized for use as critical components in life support devices or systems without the express written approval of the Chief Executive Officer of Diodes Incorporated. As used herein:

A. Life support devices or systems are devices or systems which:

1. are intended to implant into the body, or
2. support or sustain life and whose failure to perform when properly used in accordance with instructions for use provided in the labeling can be reasonably expected to result in significant injury to the user.

B. A critical component is any component in a life support device or system whose failure to perform can be reasonably expected to cause the failure of the life support device or to affect its safety or effectiveness.

Customers represent that they have all necessary expertise in the safety and regulatory ramifications of their life support devices or systems, and acknowledge and agree that they are solely responsible for all legal, regulatory and safety-related requirements concerning their products and any use of Diodes Incorporated products in such safety-critical, life support devices or systems, notwithstanding any devices- or systems-related information or support that may be provided by Diodes Incorporated. Further, Customers must fully indemnify Diodes Incorporated and its representatives against any damages arising out of the use of Diodes Incorporated products in such safety-critical, life support devices or systems.

Copyright © 2019, Diodes Incorporated

[www.diodes.com](http://www.diodes.com)

单击下面可查看定价，库存，交付和生命周期等信息

[>>Diodes Incorporated\(达尔科技\)](#)