

1.6x Linear DC Fan Driver with V_{OUT} Fully on Control**AP2113****General Description**

The AP2113 is a low dropout high performance linear regulator which is specially designed to drive a DC fan, the regulator delivers output current 600mA in minimum.

The AP2113 provides low quiescent current consumption 70μA, over current limit protection and load short current protection with fold-back limitation 50mA, which are ideal for battery powered system application.

The AP2113 output voltage (V_{OUT}) follows 1.6 times of V_{SET} input voltage until it reaches V_{IN} voltage minus dropout voltage (V_{DROP}) at adjustable mode (set \overline{FON} pin logic high). The V_{SET} voltage must be larger than 1.0V to guarantee V_{OUT} 1.6 times of V_{SET} . An \overline{FON} pin turns V_{OUT} fully on when set logic low.

The AP2113 is available in standard SOIC-8 and SOT-23-5 packages.

Features

- Output Voltage in Adjustable Mode Follows 1.6 Times of V_{SET} ($V_{OUT}/V_{SET}=1.6 \pm 3\%$)
- Low Quiescent Current: 70μA (Typ)
- Guarantee 0.6A Continuous Load
- Switchable Adjustable Mode/Full Speed Mode
- Over Current Protection
- Short Current Protection with Fold-back Limitation: 50mA
- Low Dropout Voltage:
150mV @ 600mA (Typ) at Full Speed Mode
200mV @ 600mA (Typ) at Adjustable Mode
- OTSD Protection
- Stable with 1.0μF Flexible Caps: Ceramic, Tantalum and Aluminum Electrolytic
- Operation Temperature Range: -40°C to 85°C
- ESD: MM 300V, HBM 6000V

Applications

- Notebook Computer Fan Driver
- Motherboards
- Peripheral Cards

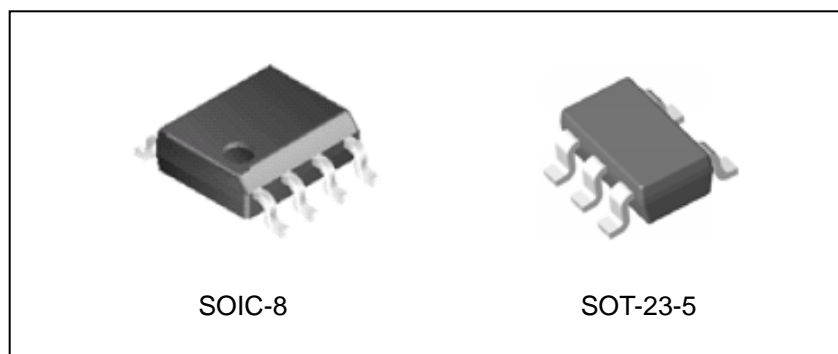


Figure 1. Package Type of AP2113

Pin Configuration

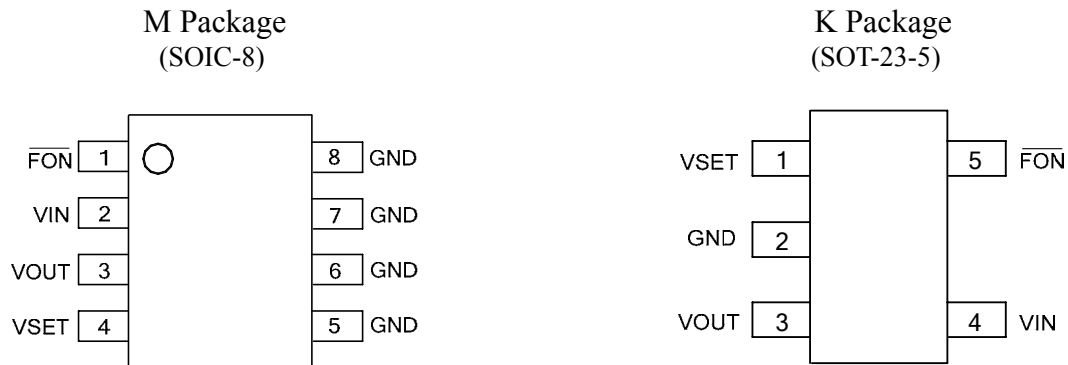


Figure 2. Pin Configuration of AP2113 (Top View)

Pin Descriptions

Pin Number		Pin Name	Function
SOIC-8	SOT-23-5		
1	5	$\overline{\text{FON}}$	Full speed mode / Adjustable mode selection input pin. Set low for full speed mode, set high for adjustable mode with 1.6x
2	4	VIN	Input voltage
3	3	VOUT	Output voltage
4	1	VSET	Voltage input pin, apply DC voltage into VSET as voltage reference, the output voltage follows 1.6 times of VSET voltage
5, 6, 7, 8	2	GND	Ground

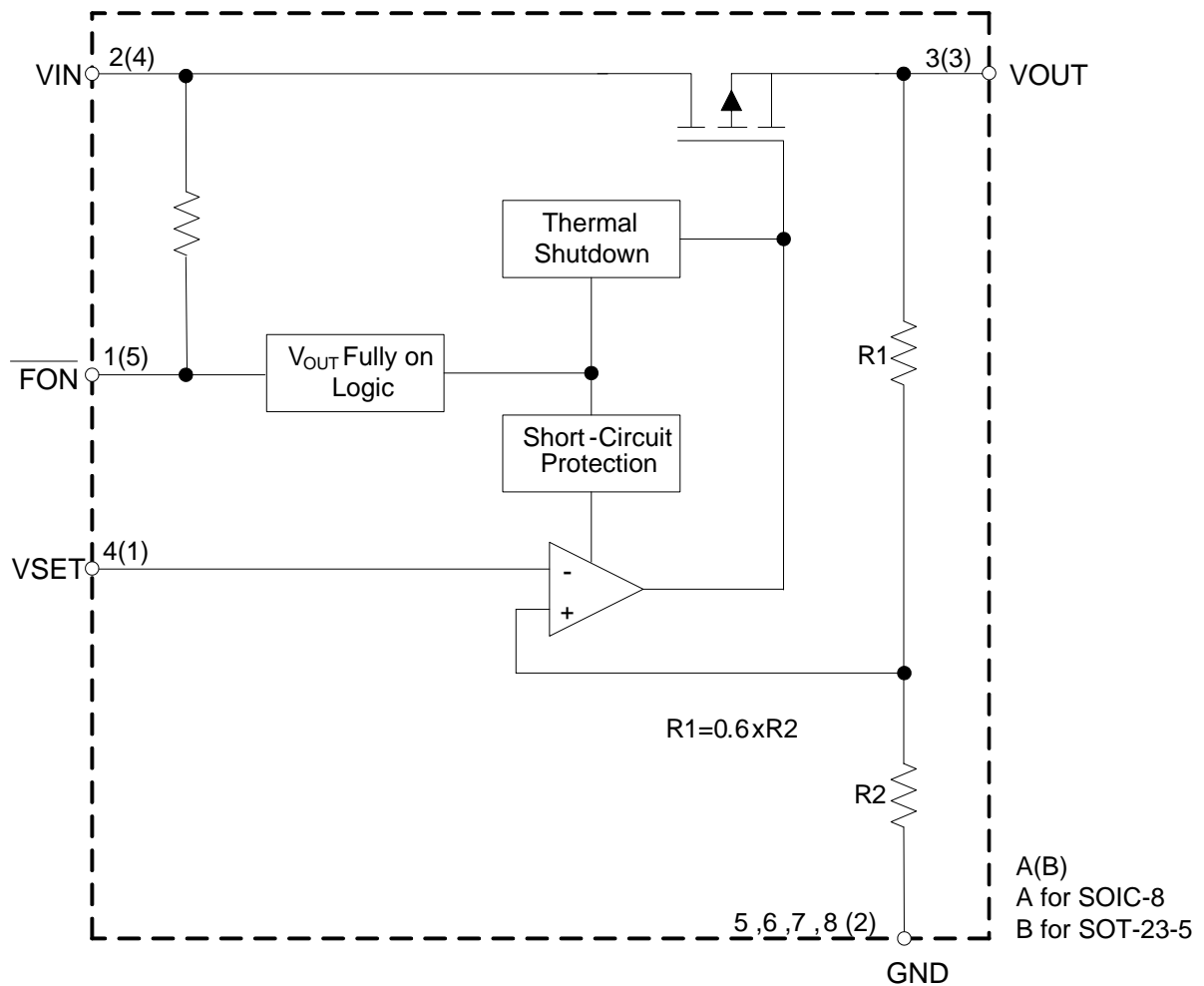
Functional Block Diagram


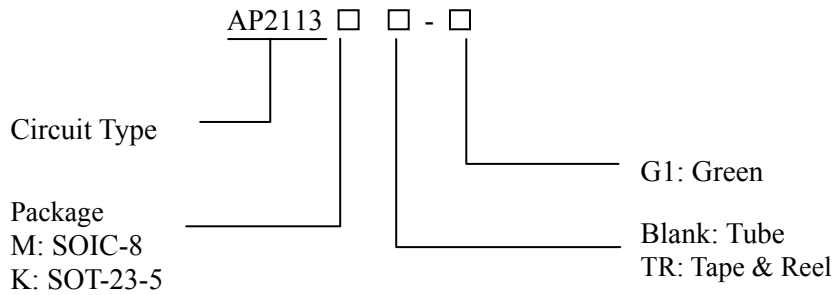
Figure 3. Functional Block Diagram of AP2113



1.6x Linear DC Fan Driver with VOUT Fully on Control

AP2113

Ordering Information



Package	Temperature Range	Part Number	Marking ID	Packing Type
SOIC-8	-40 to 85°C	AP2113M-G1	2113M-G1	Tube
		AP2113MTR-G1	2113M-G1	Tape & Reel
SOT-23-5	-40 to 85°C	AP2113KTR-G1	G50	Tape & Reel

BCD Semiconductor's Pb-free products, as designated with "G1" suffix in the part number, are RoHS compliant and Green.

**1.6x Linear DC Fan Driver with VOUT Fully on Control****AP2113****Absolute Maximum Ratings (Note 1)**

Parameter	Symbol	Value		Unit
Input Voltage	V_{IN}	6.0		V
VSET Input Voltage	V_{SET}	5.5		V
\overline{FON} Input Voltage	$V_{\overline{FON}}$	5.5		V
Operating Junction Temperature Range	T_J	150		°C
Storage Temperature Range	T_{STG}	-65 to 150		°C
Thermal Resistance (Junction to Ambient) (No Heat Sink)	θ_{JA}	SOIC-8	144	°C/W
ESD (Machine Model)		300		V
ESD (Human Body Model)		6000		V

Note 1: Stresses greater than those listed under “Absolute Maximum Ratings” may cause permanent damage to the device. These are stress ratings only, and functional operation of the device at these or any other conditions beyond those indicated under “Recommended Operating Conditions” is not implied. Exposure to “Absolute Maximum Ratings” for extended periods may affect device reliability.

Recommended Operating Conditions

Parameter	Symbol	Min	Max	Unit
Input Voltage	V_{IN}	2.5	5.5	V
Operating Ambient Temperature Range	T_A	-40	85	°C



1.6x Linear DC Fan Driver with VOUT Fully on Control

AP2113

Electrical Characteristics

V_{IN}=5.0V, V_{SET}=2V, C_{IN}=1μF, C_{OUT}=1μF, Typical T_A=25°C, Bold typeface applies over full temperature range, -40°C≤T_A≤85°C ranges, unless otherwise specified.

Parameter	Symbol	Conditions	Min	Typ	Max	Unit
Quiescent Current	I _Q	V _{FON} =5V, No Load		70	100	μA
		V _{FON} =0V, No Load			45	μA
Output Current	I _{OUT}	V _{IN} =5.0V, V _{OUT} =3.2V	600			mA
Output Voltage/ VSET Voltage	V _{OUT} /V _{SET}	V _{IN} =5.5V, V _{SET} =1V to 3.2V, I _{OUT} =30mA	1.552	1.6	1.648	V/V
Line Regulation	$\frac{(\Delta V_{OUT}/V_{OUT})}{\Delta V_{IN}}$	V _{IN} =V _{OUT} +1V to 5.5V, I _{OUT} =30mA		0.02	0.1	%/V
Load Regulation	$\frac{(\Delta V_{OUT}/V_{OUT})}{\Delta I_{OUT}}$	1mA ≤ I _{OUT} ≤ 600mA		0.2	1	%/A
Dropout Voltage	V _{DROP}	V _{IN} =5V, V _{SET} =2V, V _{FON} =0V, I _{OUT} =600mA		150	200	mV
		V _{IN} =5V, V _{SET} =2V, V _{FON} =5V, I _{OUT} =600mA		200	250	mV
Minimum VSET Voltage	V _{SET}			1		V
VSET Pin Current	I _{SET}	V _{SET} =5V			1	μA
Fold-back Short Current	I _{SHORT}	V _{OUT} =0V		50		mA
Output Current Limit	I _{LIMIT}			1000		mA
FON Logic Input High Level			1.6		5.5	V
FON Logic Input Low Level			0		0.4	V
FON Pin Bias Current		V _{FON} =0V		1.5	10	μA
Thermal Shutdown Temperature	T _{OTSD}			165		°C
Thermal Shutdown Hysteresis	T _{HYOTSD}			25		

Typical Performance Characteristics

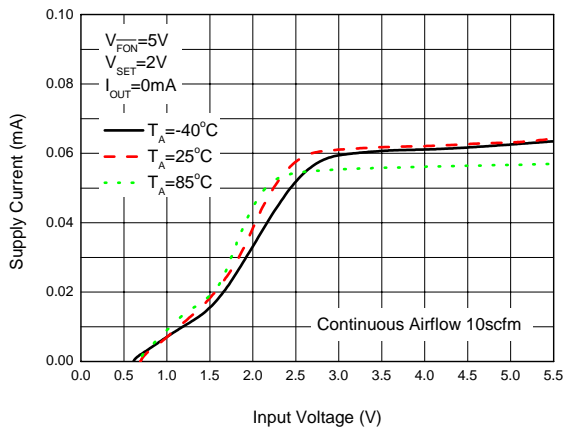


Figure 4. Supply Current vs. Input Voltage

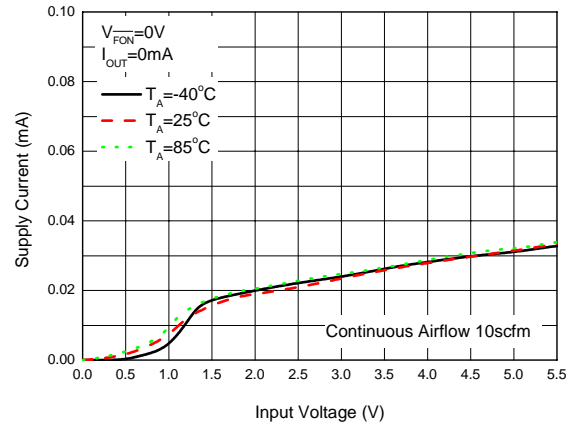


Figure 5. Supply Current vs. Input Voltage

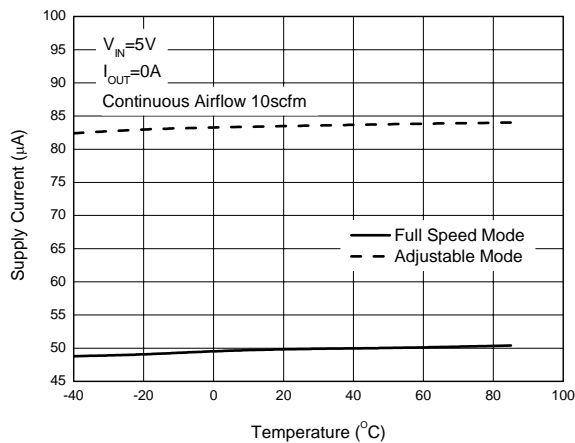


Figure 6. Supply Current vs. Temperature

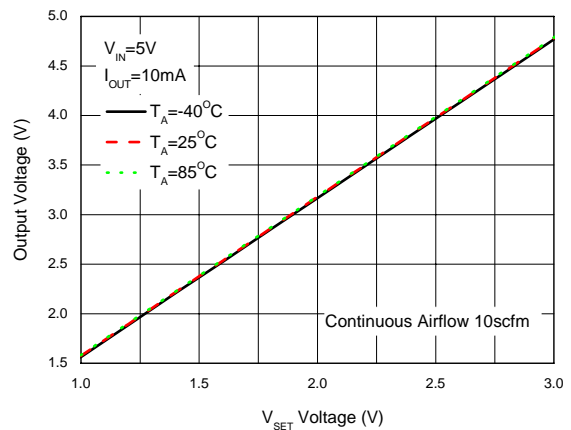


Figure 7. Output Voltage vs. V_{SET} Voltage

Typical Performance Characteristics (Continued)

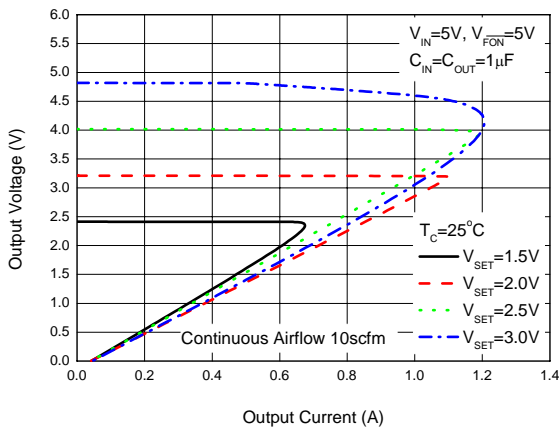


Figure 8. Output Voltage vs. Output Current

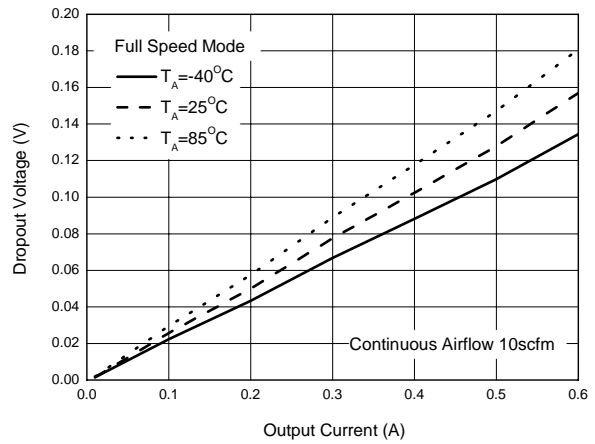


Figure 9. Dropout Voltage vs. Output Current

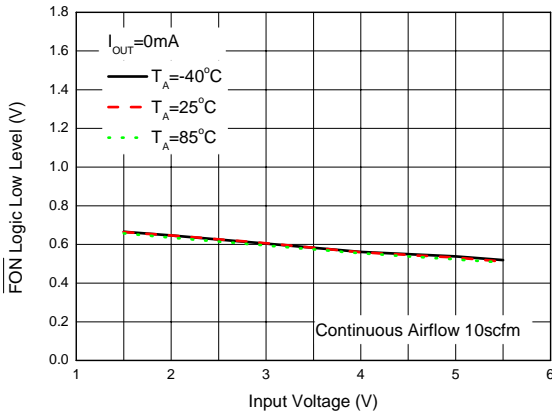


Figure 10. $\overline{\text{FON}}$ Logic Low Level vs. Input Voltage

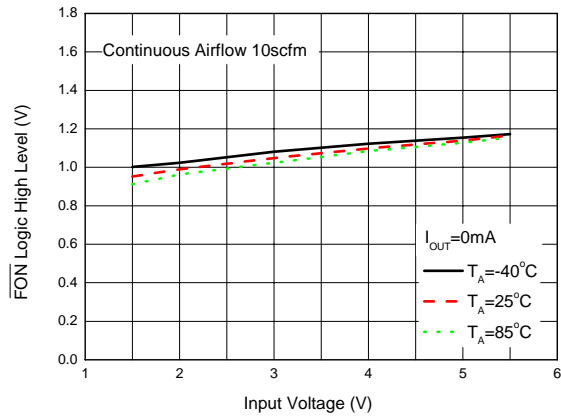


Figure 11. $\overline{\text{FON}}$ Logic High Level vs. Input Voltage

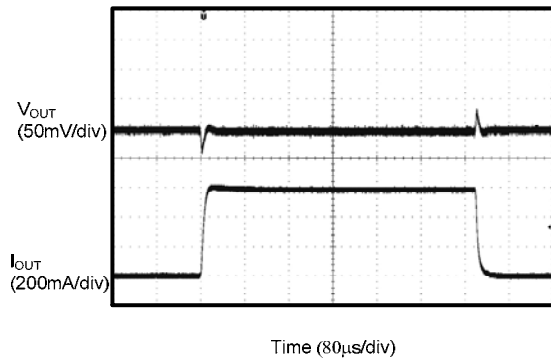
Typical Performance Characteristics (Continued)


Figure 12. Load Transient
 ($V_{IN}=5V$, $V_{SET}=2V$, $V_{FON}=5V$, $C_{IN}=C_{OUT}=1\mu F$,
 Slew Rate=250mA/µs)

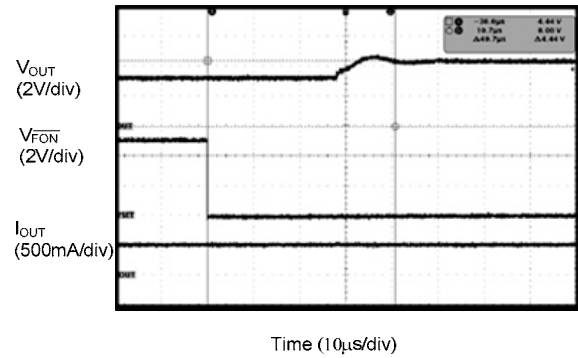


Figure 13. Mode Change Delay Time (V_{FON} Off)

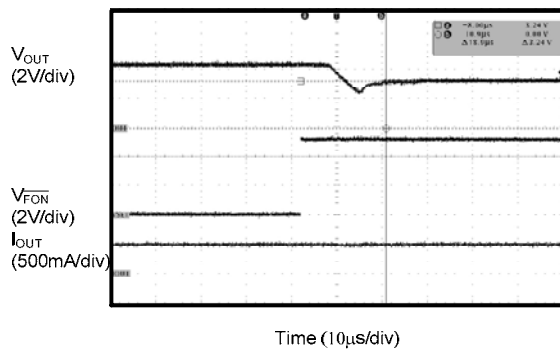


Figure 14. Mode Change Delay Time (V_{FON} On)

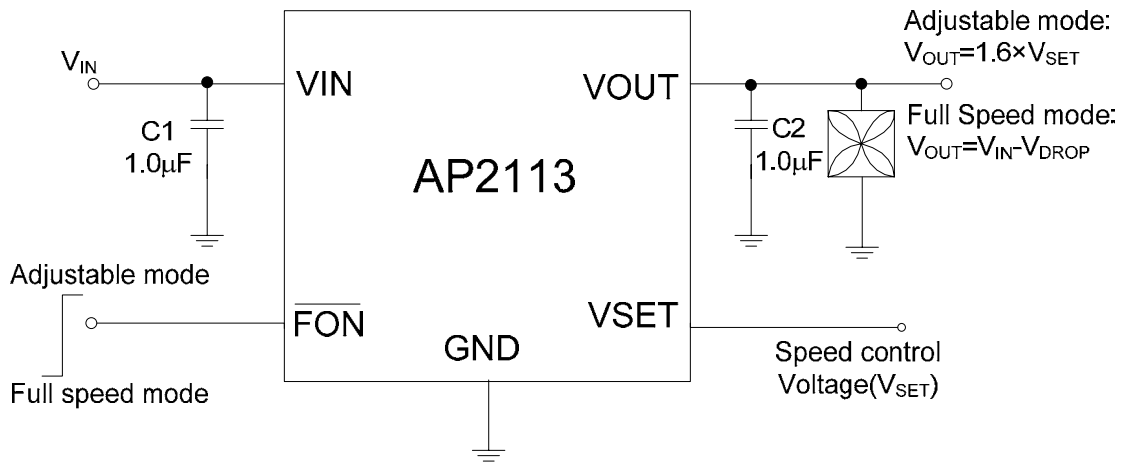
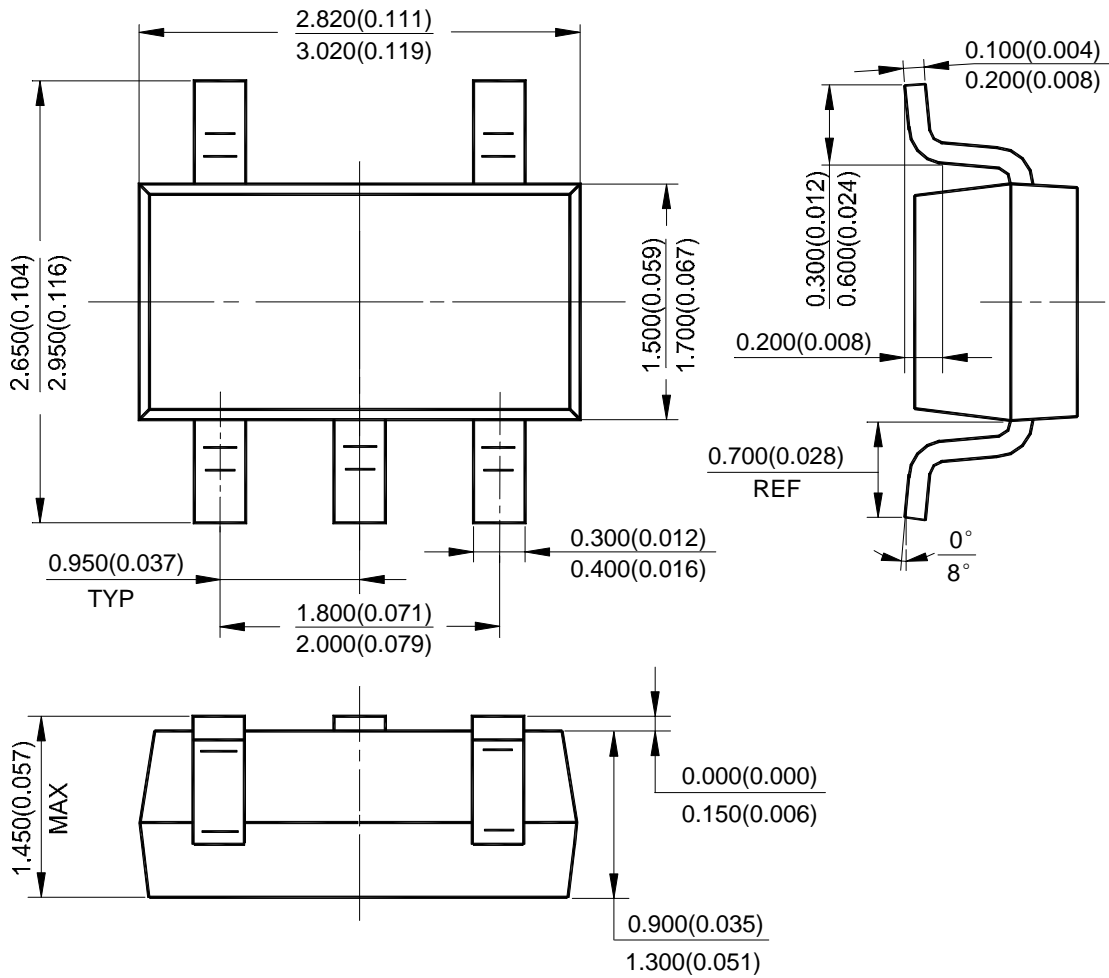
Typical Application


Figure 15. Typical Application of AP2113

Mechanical Dimensions (Continued)

SOT-23-5

Unit: mm(inch)





BCD Semiconductor Manufacturing Limited

<http://www.bcdsemi.com>

IMPORTANT NOTICE

BCD Semiconductor Manufacturing Limited reserves the right to make changes without further notice to any products or specifications herein. BCD Semiconductor Manufacturing Limited does not assume any responsibility for use of any its products for any particular purpose, nor does BCD Semiconductor Manufacturing Limited assume any liability arising out of the application or use of any its products or circuits. BCD Semiconductor Manufacturing Limited does not convey any license under its patent rights or other rights nor the rights of others.

MAIN SITE

- Headquarters

BCD Semiconductor Manufacturing Limited

No. 1600, Zi Xing Road, Shanghai ZiZhu Science-based Industrial Park, 200241, China
Tel: +86-21-24162266, Fax: +86-21-24162277

- Wafer Fab

Shanghai SIM-BCD Semiconductor Manufacturing Co., Ltd.

800 Yi Shan Road, Shanghai 200233, China
Tel: +86-21-6485 1491, Fax: +86-21-5450 0008

REGIONAL SALES OFFICE

Shenzhen Office

Shanghai SIM-BCD Semiconductor Manufacturing Co., Ltd., Shenzhen Office

Unit A Room 1203, Skyworth Bldg., Gaoxin Ave. 1.S., Nanshan District, Shenzhen, China
Tel: +86-755-8826 7951
Fax: +86-755-8826 7865

Taiwan Office

BCD Semiconductor (Taiwan) Company Limited

4F, 298-1, Rui Guang Road, Nei-Hu District, Taipei, Taiwan
Tel: +886-2-2656 2808
Fax: +886-2-2656 2806

USA Office

BCD Semiconductor Corp.

30920 Huntwood Ave. Hayward, CA 94544, USA
Tel : +1-510-324-2988
Fax: +1-510-324-2788

单击下面可查看定价，库存，交付和生命周期等信息

[>>Diodes Incorporated\(达达科技\(美台\)\)](#)