

## USB 2.0 Port Protection with Charger Detection

### Features

- USB-device charger detector
- Can tolerate USB3.0-PD with VBUS = 20V
- USB Charging-type detection
- Battery Charging 1.2 (BC1.2) – DCP
- Battery Charging 1.2 (BC1.2) – CDP
- Battery Charging 1.2 (BC1.2) – SDP
- Apple 1A, 2A, & 2.4A dedicated chargers
- Samsung-Fast chargers
- YD/T-1951 dedicated chargers
- CEA-936 Carkit#1 and #2 chargers
- Integrated Power FET
- VBUS Tolerance up to 28V
- 1.7A Over-Current Protection (OCP)
- VBUS Over-Voltage Protection (OVP)
- Non-charging Accessory Detection
- USB On-The-Go (OTG) detection
- Mobile HDMI Link (MHL) device detection
- Wide Supply Voltage Range 3V to 5.5V
- I<sup>2</sup>C Programmability
- Small Package: CSP 1.5x2.0-15L

### Applications

- Personal Media Players
- Mobile Phones
- Tablet

### Pin Configuration

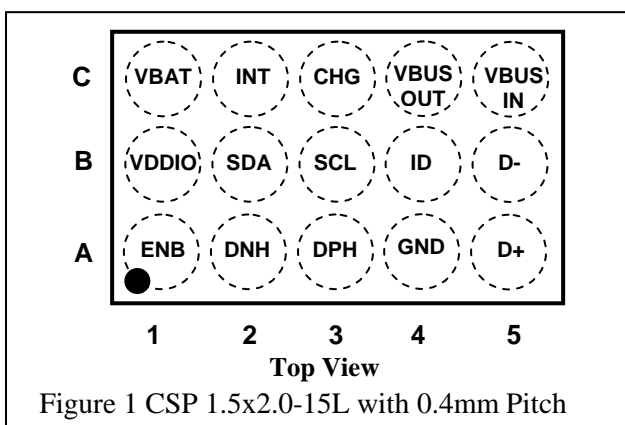

### Description

PI3USB9281 provides external detection for any USB-device. The part can detect various chargers available in the market, MHL accessories, OTG accessories, and car-chargers per the CEA936 spec. It also integrates a power switch with over-voltage and over-current protections. The VBUSIN input pin can tolerate voltages up to 28V, which is important for USB3.0-PowerDelivery enabled ports. The new USB-3.0-PowerDelivery specification supports voltages up to 20V.

The PI3USB9281 can operate over a temperature range of -40 to +85 °C.

Typical applications involve portable & consumer applications, such as tablet, smart phones, digital cameras, and notebooks with integrated Li-ion batteries that charge via USB connectors.

### Block Diagram

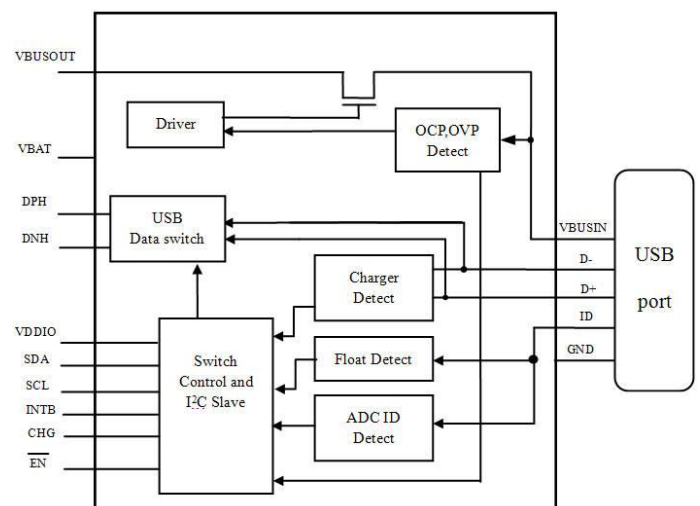

Figure 2. PI3USB9281 Block diagram

## Pin Descriptions

Name	Type	Default State	Description
<b>USB Interface</b>			
DPH	Signal Path	Open	D+ signal switch path, dedicated USB port to be connected to the resident USB transceiver on the device
DNH	Signal Path	Open	D- signal switch path, dedicated USB port to be connected to the resident USB transceiver on the device
<b>Connector Interface</b>			
ID	Signal Path	Open	Connected to the USB connector ID pin and used for detecting accessories
D+	Signal Path	Open	Connected to the USB connector D+ pin; depending on the signaling mode
D-	Signal Path	Open	Connected to the USB connector D- pin; depending on the signaling mode
V <sub>BUSIN</sub>	Power Path	NA	Input voltage supply pin to be connected to the VBUS pin of the USB connector
<b>Power Interface</b>			
V <sub>BAT</sub>	Power	NA	Input voltage supply pin to be connected to the device battery output or to an internal regulator
V <sub>DDIO</sub>	Power	NA	Baseband processor interface I/O supply pin
ENB	Input	Hi-Z	System enable for the circuit (Active Low)
GND	Power	NA	Ground
<b>Charger Interface</b>			
V <sub>BUSOUT</sub>	Power Path	NA	Output voltage supply pin to be connected to the source voltage pin on the charger IC
CHG	Open-Drain Output	Hi-Z	Open-drain active LOW output, used to signal the charger IC that a charger has been attached
<b>I<sup>2</sup>C Interface</b>			
SCL	Input	Hi-Z	I <sup>2</sup> C serial clock signal to be connected to the phone-based I <sup>2</sup> C master
SDA	Open-Drain I/O	Hi-Z	I <sup>2</sup> C serial data signal to be connected to the phone-based I <sup>2</sup> C master
INTB	CMOS Output	LOW	Interrupt active LOW output used to prompt the phone baseband processor to read the I <sup>2</sup> C register bits, indicates a change in ID pin status or accessory attach status

## Maximum Ratings

Storage Temperature .....	-65°C to +150°C
Supply Voltage from Battery/Baseband .....	-0.5V to +6.5V
Supply Voltage from Micro-USB Connector .....	-0.5V to +28.0V
Switch I/O Voltage USB .....	-1.0V to +5.5V
Input Clamp Diode current .....	50mA
Charger Detect CHG Pin Sink current .....	30mA
Switch I/O Current (Continuous) USB .....	50mA
Switch I/O Switch Peak Current (Pulsed at 1ms Duration, <10% Duty Cycle) USB, and All Other Channels .....	150mA
Charger FET .....	2A
ESD: HBM .....	2000V
HBM (USB connector pins: VBUSIN, D+, D-, ID to GND) .....	6000V

### Note:

Stresses greater than those listed under MAXIMUM RATINGS may cause permanent damage to the device. This is a stress rating only and functional operation of the device at these or any other conditions above those indicated in the operational sections of this specification is not implied. Exposure to absolute maximum rating conditions for extended periods may affect reliability.

## Recommended operation conditions

Symbol	Parameter	Min.	Max.	Units
V <sub>BAT</sub>	Battery Supply Voltage	3.0	5.5	V
V <sub>BAT_TH</sub>	Battery Supply Voltage Threshold	-	3.0	V
V <sub>BUSIN</sub>	V <sub>BUSIN</sub> Pin Supply Voltage	4.0	5.5	V
V <sub>DDIO</sub>	Processor Supply Voltage	1.8	5.5	V
V <sub>SW</sub>	Switch I/O Voltage	0	3.6	V
	USB Path Active			
C <sub>ID</sub>	Capacitive Load on ID Pin for Reliable Accessory Detection	0	1.0	nF
T <sub>A</sub>	Operating Temperature	-40	85	°C

### Switch Path DC Electrical Characteristics

Min and Max apply for  $T_A$  between  $-40\text{ }^\circ\text{C}$  to  $85\text{ }^\circ\text{C}$  and  $T_J$  up to  $+125\text{ }^\circ\text{C}$  (unless otherwise noted). Typical values are referenced to  $T_A=+25\text{ }^\circ\text{C}$

Symbol	Parameter	Test Conditions	Min.	Typ.	Max.	Units
<b>USB Data Switches (D+, D-)</b>						
$R_{ONUSB}$	USB Switch On-Resistance	$I_{LOAD}=8\text{mA}$ , $V_{D+ / D-}=0\text{V}$ , $0.4\text{V}$	-	2.5	3.1	$\Omega$
USB Analog Signal Voltage Range		$V_{BAT}=3.0$ to $4.4\text{V}$	0	-	3.6	V
<b>Charging FET Switch</b>						
$V_{OVP}$	Over-Voltage Protection (OVP) Threshold Voltage		6.2	6.8	7.2	V
$R_{ONCHG}$	Charging FET On-Resistance	$V_{BUSIN}=4.2\text{V}-5.0\text{V}$ , $I_{LOAD}=1\text{A}$	-	100	150	$\text{m}\Omega$
$I_{OCP}$	Over-Current Protection (OCP) Threshold Current <sup>(2)</sup>	$V_{BUSIN}=5\text{V}$	1.5	1.7	1.9	A
<b>Host Interface Pins (INTB, CHG)</b>						
$V_{OH}$	Output High Voltage	$I_{OH}=2\text{mA}$ , $V_{BAT}=3.0$ to $4.4\text{V}$	$0.7 \times V_{DDIO}$	-	-	V
$V_{OL}$	Output Low Voltage	$I_{OL}=10\text{mA}$ , $V_{BAT}=3.0$ to $4.4\text{V}$	-	-	0.4	V
<b>Current Consumption</b>						
$I_{CC}$	Battery Supply Current	No Accessory Static Current, $V_{BAT}=3.6\text{V}$ , $V_{BUSIN}=0\text{V}$	-	20	30	$\mu\text{A}$
		With Accessory Static Current, $V_{BAT}=3.6\text{V}$ , $V_{BUSIN}=0\text{V}$	-	50	80	$\mu\text{A}$
		With Accessory Static Current, $V_{BAT}=3.6\text{V}$ , $V_{BUSIN}=5\text{V}$	-	-	1	$\mu\text{A}$
$I_{STANDBY}$	Battery Supply Standby Current	$V_{BAT}=3.6\text{V}$ , $V_{BUSIN}=0\text{V}$ , $ENB=3.6\text{V}$	-	-	1	$\mu\text{A}$
$I_{OFF}$	Power-Off Leakage Current	$V_{BAT}=0\text{V}$ , $V_{SW}=0$ to $4.4\text{V}$	-	-	10	$\mu\text{A}$
$I_{ON(OFF)}$	Off Leakage Current	$V_{BAT}=3.0$ to $4.4\text{V}$ , I/O pins= $0.3\text{V}$ , $4.1\text{V}$	-0.1	0.001	0.1	$\mu\text{A}$
$I_{IDSHORT}$	Short-Circuit Current <sup>(2)</sup>	$V_{BAT}=3.0$ to $4.4\text{V}$ , $I_D=0\text{V}$	-	5	-	$\text{mA}$

**Note:**

1. On-resistance is the voltage drop between the two terminals at the indicated current through the switch.
2. Limits based on electrical characterization data.

### Capacitance ( $T_A = -40\text{ }^\circ\text{C}$ to $85\text{ }^\circ\text{C}$ )

Symbol	Parameter	Test Conditions	Min.	Typ.	Max.	Units
$C_{ONUSB}$	D+, D- On Capacitance (USB Mode)	$V_{BAT}=3.8\text{V}$ , $f=1\text{MHz}$	-	4.0	-	$\text{pF}$

### Switch AC Electrical Characteristics

Min and Max apply for  $T_A$  between  $-40\text{ }^\circ\text{C}$  to  $85\text{ }^\circ\text{C}$  and  $T_J$  up to  $+125\text{ }^\circ\text{C}$  (unless otherwise noted). Typical values are referenced to  $T_A=+25\text{ }^\circ\text{C}$ ,  $V_{BAT}=3.8\text{V}$ .

Symbol	Parameter	Test Conditions	Min.	Typ.	Max.	Units	
$BW_{USB}$	-3dB Bandwidth of USB channel		-	1300	-	MHz	
$O_{IRR}$	OFF-Isolation	USB Mode	$f=1\text{MHz}$ , $R_S=50\Omega$ , $C_L=0$	-	-70	-	dB
$X_{TALK}$	Active Channel Crosstalk D+ to D-	USB Mode	$f=1\text{MHz}$ , $R_S=50\Omega$ , $C_L=0$	-	-70	-	dB
			$f=240\text{MHz}$ , $R_S=50\Omega$ , $C_L=0$	-	-30	-	
$t_{SK(P)}$	Skew of Opposite Transitions of the Same Output (USB Mode)	$t_r=t_f=750\text{ps}$ (10-90%) at $240\text{MHz}$ , $C_L=0\text{pF}$ , $R_L=50\Omega$	-	30	-	ps	
$t_{I2CRST}$	Time When $I^2C\_SDA$ and $I^2C\_SCL$ Both LOW to Cause a Reset	-	15	-	-	ms	
$t_{INTMASK}$	Time after INT Mask Cleared to "0" until INTB Goes LOW to Signal the Interrupt after Interruptible Event while INT Mask Bit Set to "1"	-	25	-	-	ms	
$t_{SDPDET}$	Time from $V_{BUSIN}$ Valid to $V_{BUSOUT}$ Valid with Charger FET Closed and USB Switches Closed for USB Standard Downstream Port	See Figure 6	-	200	-	ms	
$t_{CHGOUT}$	Time from $V_{BUSIN}$ Valid to $V_{BUSOUT}$ Valid with Charger FET Closed for USB Charging Ports(CDP and DCP)	See Figure 4 and Figure 5	-	200	-	ms	
$t_{CARKIT}$	Time from $V_{BUSIN}$ Valid to Car Kit Type 1 or Type 2 Charger Detected	See Figure 8	-	130	-	ms	
$t_{IDDET}$	Time from ID Not Floating to INTB LOW to Signal Accessory Attached that is ID Resistance-Based Only ( $V_{BUSIN}$ Not Valid)	See Figure 9	-	100	-	ms	

### I<sup>2</sup>C Controller DC Electrical Characteristics

Symbol	Parameter	Fast Mode (400kHz)		Units	
		Min.	Max.		
$V_{IL}$	Low-Level Input Voltage	-0.5	$0.3V_{DDIO}$	V	
$V_{IH}$	High-Level Input Voltage	$0.7V_{DDIO}$	-	V	
$V_{HYS}$	Hysteresis of Schmitt Trigger Inputs	$V_{DDIO}>2\text{V}$	$0.05V_{DDIO}$	-	V
		$V_{DDIO}<2\text{V}$	$0.1V_{DDIO}$	-	
$V_{OL1}$	Low-Level Output Voltage at 3mA Sink Current (Open-Drain)	$V_{DDIO}>2\text{V}$	0	0.4	V
		$V_{DDIO}<2\text{V}$	-	$0.2V_{DDIO}$	
$I_{I2C}$	Input Current of I <sup>2</sup> C SDA and SCL Pins, Input Voltage 0.26V to 2.34V	-10	10	$\mu\text{A}$	
$C_I$	Capacitance for Each I/O Pin	-	10	pF	

### I<sup>2</sup>C AC Electrical Characteristics

Symbol	Parameter	Fast Mode (400kHz)		Units
		Min.	Max.	
$f_{SCL}$	SCL Clock Frequency	0	400	kHz
$t_{HDSTA}$	Hold Time (Repeated) START Condition	0.6	-	$\mu\text{s}$
$t_{LOW}$	LOW Period of SCL Clock	1.3	-	$\mu\text{s}$
$t_{HIGH}$	HIGH Period of SCL Clock	0.6	-	$\mu\text{s}$
$t_{SETSTA}$	Set-up Time for Repeated START Condition	0.6	-	$\mu\text{s}$
$t_{HDDAT}$	Data Hold Time	0	0.9	$\mu\text{s}$
$t_{SETDAT}$	Data Set-up Time <sup>(1)</sup>	100	-	ns
$t_r$	Rise Time of SDA and SCL Signals <sup>(2)</sup>	$20+0.1C_b$	300	ns
$t_f$	Fall Time of SDA and SCL Signals <sup>(2)</sup>	$20+0.1C_b$	300	
$t_{SETSTO}$	Set-up Time for STOP Condition	0.6	-	$\mu\text{s}$
$t_{BUF}$	Bus-Free Time between STOP and START Conditions	1.3	-	$\mu\text{s}$
$t_{SP}$	Pulse Width of Spikes that Must Be Suppressed by the Input Filter	0	50	ns

Notes:

1. A fast-mode I<sup>2</sup>C-bus device can be used in a standard-mode I<sup>2</sup>C-bus system, but the requirement  $t_{SETDAT} \geq 250\text{ns}$  must be met.

This is automatically the case if the device does not stretch the LOW period of the SCL signal. If such a device does stretch the LOW period of the SCL signal, it must output the next data bit to the SDA line  $t_{r\_max} + t_{SETDAT} = 1000 + 250 = 1250ns$  (according to the standard-mode I<sup>2</sup>C bus specification) before the SCL line is released.

2.  $C_b$  equals the total capacitance of one BUS line in pF. If mixed with high-speed devices, faster fall times are allowed according to the I<sup>2</sup>C specification.

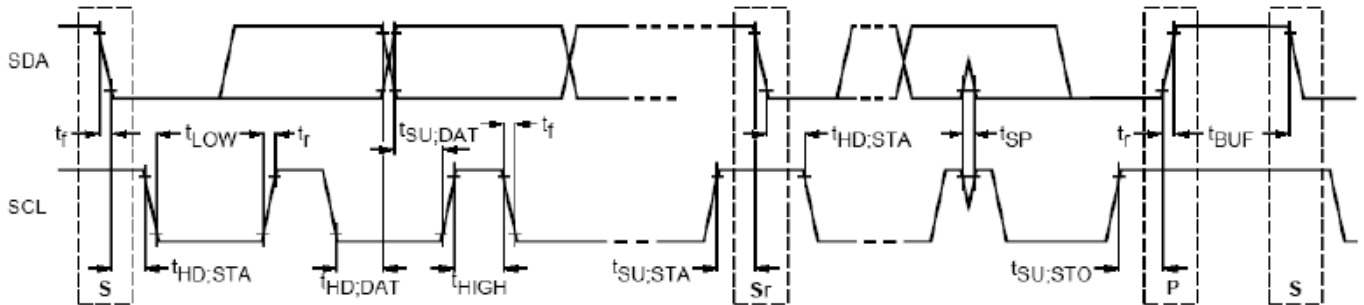

**Definition of Timing for Full-Speed Mode Devices on the I<sup>2</sup>C Bus**

**Table 2. I<sup>2</sup>C Slave Address**

Name	Size (Bits)	Bit 7	Bit 6	Bit 5	Bit 4	Bit 3	Bit 2	Bit 1	Bit 0
Slave Address	8	0	1	0	0	1	0	1	R/W

**Table 3 Register Map**

Address	Register	Type	Reset Value	Bit 7	Bit 6	Bit 5	Bit 4	Bit 3	Bit 2	Bit 1	Bit 0
01H	Device ID	Read	00000000	Version ID : 00010				Vendor ID(Pericom): 000			
02H	Control	Read/Write	00011111	Reserved: -Read xxx -Write 000			Switch Open 0: Open all switches 1: Switch based on detection	Reserved:	Manual Switch 0: Manual configuration 1: Automatic configuration	Reserved	Global Interrupt Mask 0: Does not Mask Interrupts 1: Mask Interrupts
03H	Interrupt	Read/Clear	00000000	OVP&OCP Recovery	OCP Event	OVP Event	Reserved			Detach	Attach
				0: OVP and/or OCP event not recovered	0: No OCP event	0: No OVP event	0: No Interrupt				
				1: OVP and/or OCP event recovered	1: OCP event	1: OVP event	Reserved:-Read xxx, -Write 000		1: accessory detached	1: accessory attached	
05H	Interrupt Mask	Read/Write	00000000	OVP&OCP	OCP	OVP	Reserved			Detach	Attach
				0: No Interrupt Mask				Reserved:-Read xxx, -Write 000		1: Mask Detach interrupt	1: Mask Attach interrupt

**To be continued.**

**Register Map (Continuously.)**

Address	Register	Type	Reset Value	Bit 7	Bit 6	Bit 5	Bit 4	Bit 3	Bit 2	Bit 1	Bit 0		
0AH	Device Type	Read	00000000	Reserved	USB Charging (DCP)	USB Charging (CDP)	Car Kit Charger	Reserved	USB Data (SDP)	OTG	MHL		
				0: No Detect								1: USB OTG or Unidentified Devices detected	1: MHL detected
0EH	Charger Status	Read	00000000	Reserved: -Read xxx -Write 000	Apple Charger Type			Charger Type					
					0: No Detect						00: No connection		
					1: 2.4A Apple charger detected	1: 2A Apple charger detected	1: 1A Apple charger detected	01: Reserved Charger					
								10: Car Kit charger type1					
13H	Manual Switch	Read/Write	00000000	D- Connection			D+ Connection			V <sub>BUS</sub> Connection			
				000: Open D- switch 001: D- connected to DNH of USB port			000: Open D+ switch 001: D+ connected to DPH of USB port			00: Open V <sub>BUS</sub> switch 11: V <sub>BUSOUT</sub> connected to V <sub>BUSIN</sub>			
1BH	Reset	Read/Write	x0001000	Reserved: -Read xxxxxxxx, -Write 0000000							<b>Reset</b> 0: No Reset 1: Reset (Always reads 0)		
1DH	VBUS	Read	00000000	Reserved: -Read xxxxxx, -Write 000000						V <sub>BUSIN</sub> Valid		Reserved: -Read x, -Write 0	
										0: V <sub>BUSIN</sub> Not Valid			
										1: V <sub>BUSIN</sub> Valid			

**Note:** Register address 04H, 06H, 07H, 08H, 09H, 0BH, 0CH, 0DH, 0FH, 10H, 11H, 12H, 14H, 15H, 16H, 17H, 18H, 19H, 1AH, 1CH, 1EH, 1FH, 20H and 21H are reserved

## Functional Description

### USB Port Accessory Detection List

Summarized below in Table 1 are the types of USB2.0 ports that PI3USB9281 can detect.

**Table 1. ID and V<sub>BUSIN</sub> Detection for USB Devices**

V <sub>BUS</sub>	D+	D-	USB switch	ID Resistance to GND <sup>(5)</sup>			CHG	Accessory Detected <sup>(1)</sup>
				Min.	Typ.	Max.		
x	x	x	Enable	GND	GND	GND	Hi-z	OTG
x	x	x	Disable	950Ω	1kΩ	1.05Ω	Hi-z	MHL
5V	x	x	Enable	190kΩ	200kΩ	210kΩ	LOW	Car Kit Type 1 Charger <sup>(2)</sup>
5V	x	x	Enable	419.9kΩ	442kΩ	464kΩ	LOW	Car Kit Type 2 Charger <sup>(2)</sup>
5V	2V	2.7V	Enable	3MΩ	Open	Open	LOW	1A Apple Charger
5V	2.7V	2V	Enable	3MΩ	Open	Open	LOW	2A Apple Charger
5V	2.7V	2.7V	Enable	3MΩ	Open	Open	LOW	2.4A Apple Charger
5V	(3)	(3)	Enable	3MΩ	Open	Open	LOW	USBBC1.2 DCP mode or Samsung FAST Charger <sup>(4)</sup>
5V	(3)	(3)	Enable	3MΩ	Open	Open	LOW	USB BC1.2 CDP Mode
5V	(3)	(3)	Enable	3MΩ	Open	Open	Hi-z	USB BC1.2 SDP Mode

**Notes:**

1. The accessory type is reported in the Device Type 1 (0Ah) and Charger Status (0Eh) registers with each valid accessory detection.
2. Follows the ANSI/CEA-936-A USB Car Kit specification.
3. The PI3USB9281 follows the Battery Charging 1.2 specification, which uses D+ and D- to determine what USB accessory is attached.
4. Samsung 1.2V fast charger will recognize as DCP attachment and enable the fast charging operation.
5. For devices with ID resistance other than those listed in Table 1, PI3USB9281 reports device attachment through I<sup>2</sup>C to the embedded controller. The Unknown devices are mapped to OTG such that data switches are turned on to allow embedded controller to communicate and identify the unknown devices through USB protocols.

**USB Port Detection Flowchart**

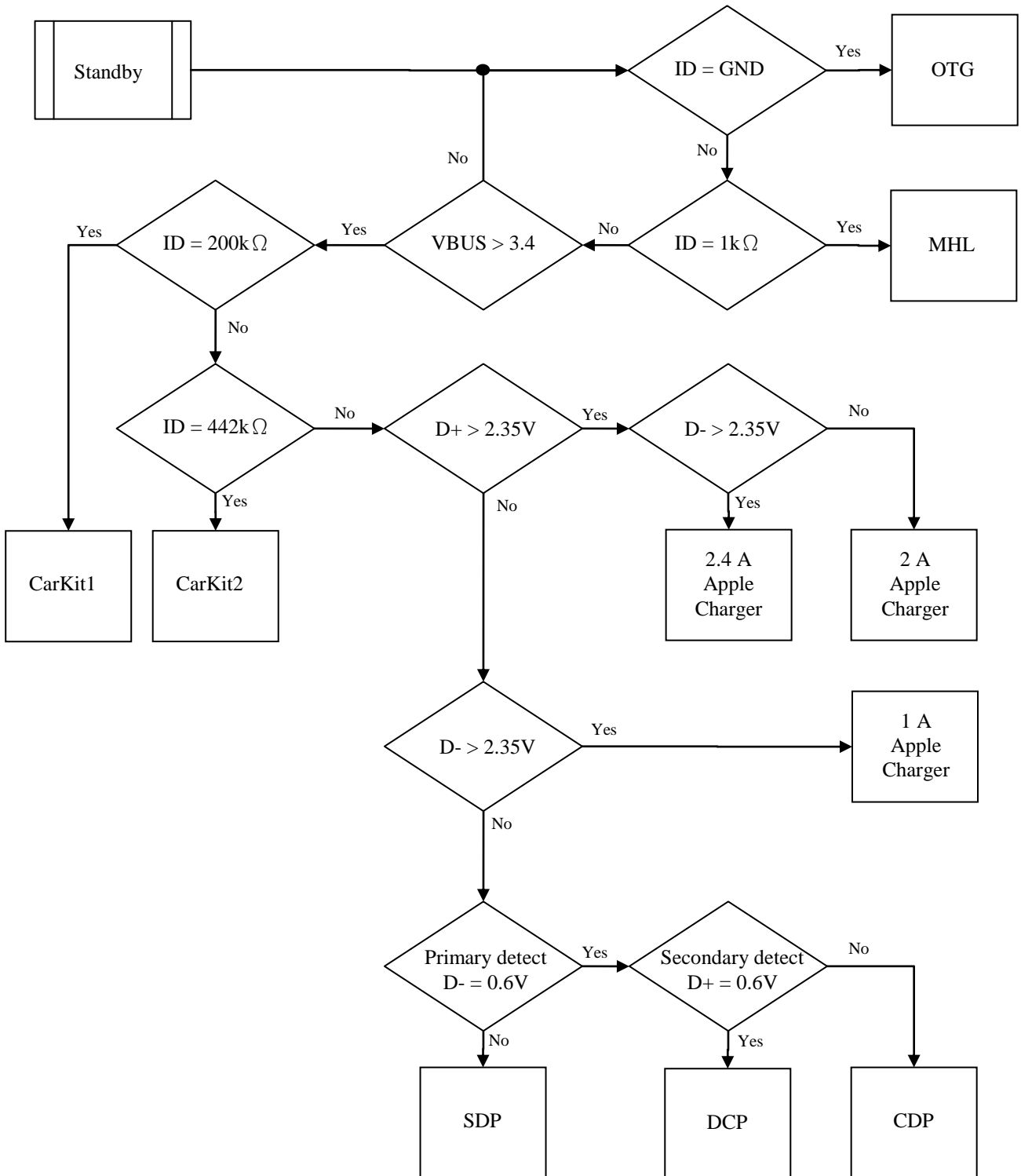
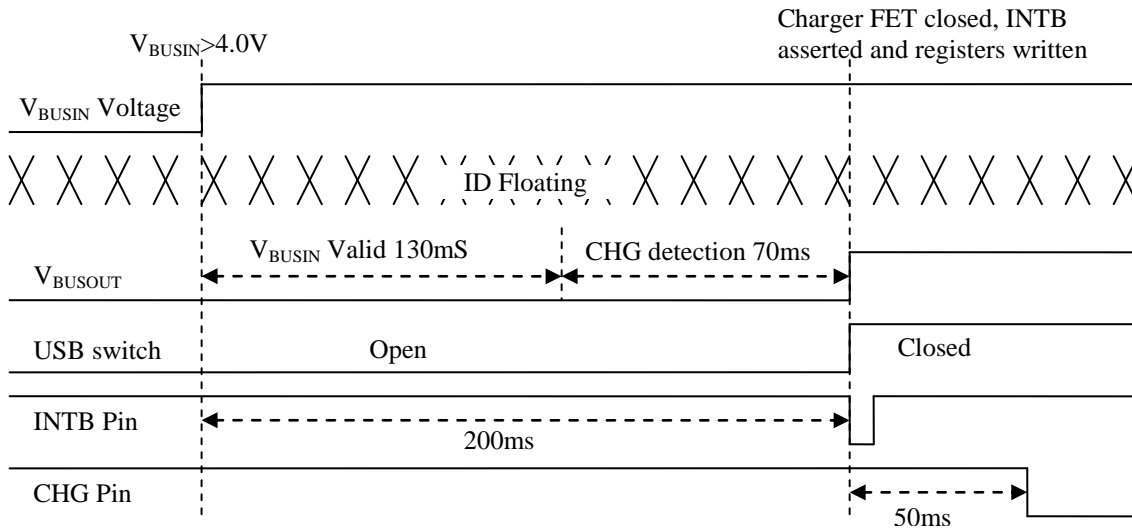

**Figure 3. Accessory detection flowchart**



**USB Port Detection Timing**

The following figures show the attach timing of the USB after insertion of accessories and the relationship between the INTB assertion and the CHG assertion. PI3USB9281 has incorporated a  $V_{BUS}$  de-bounce circuit that waits a settle time of the USB cable.



**Figure 4. USB Charging Downstream Port (CDP) Attach Timing**

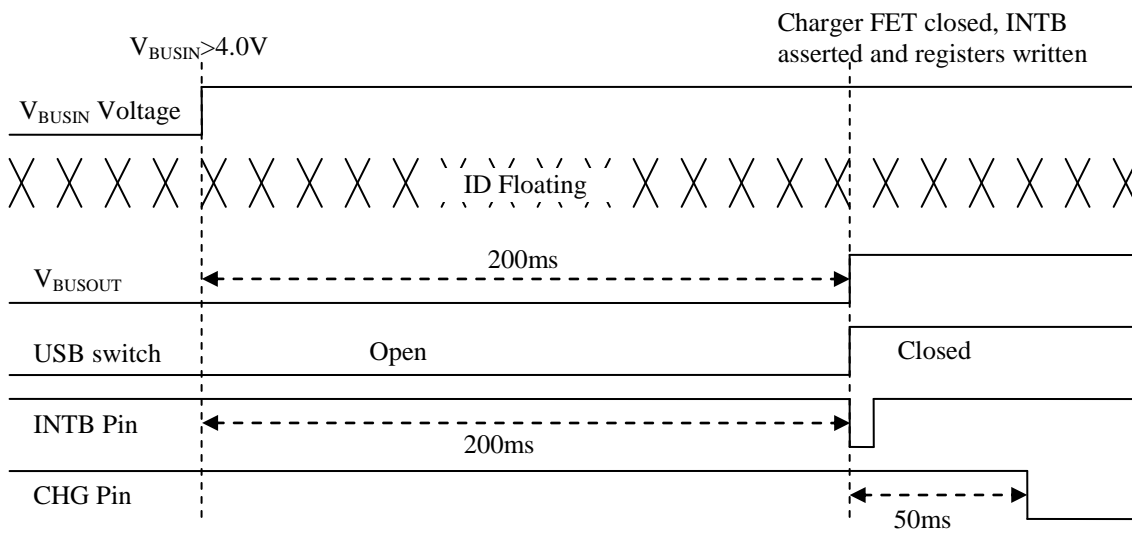

**Figure 5. USB Dedicated Charging Port (DCP) Attach Timing**

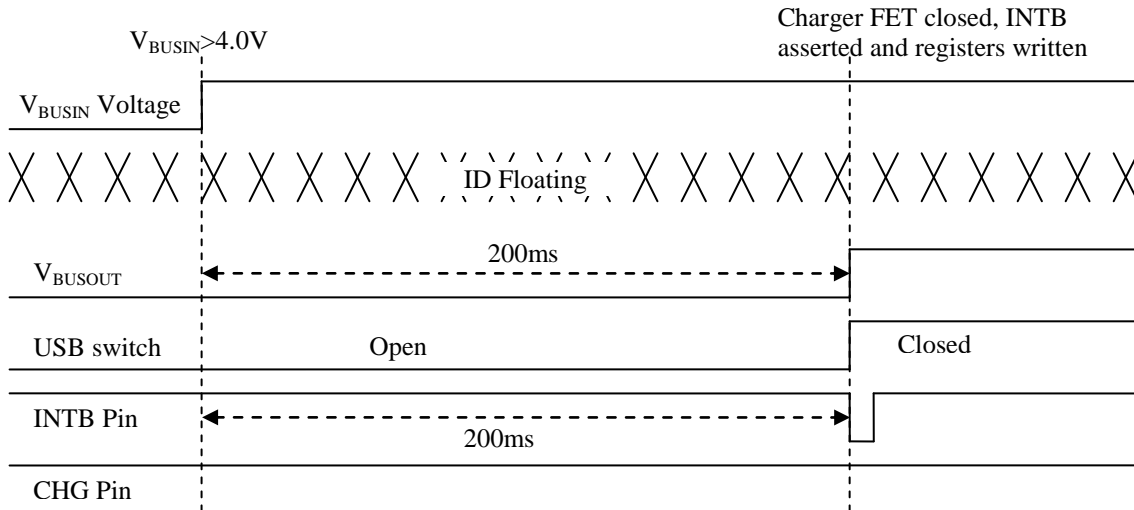

**Figure 6. USB Standard Downstream Port (SDP) Attach Timing**

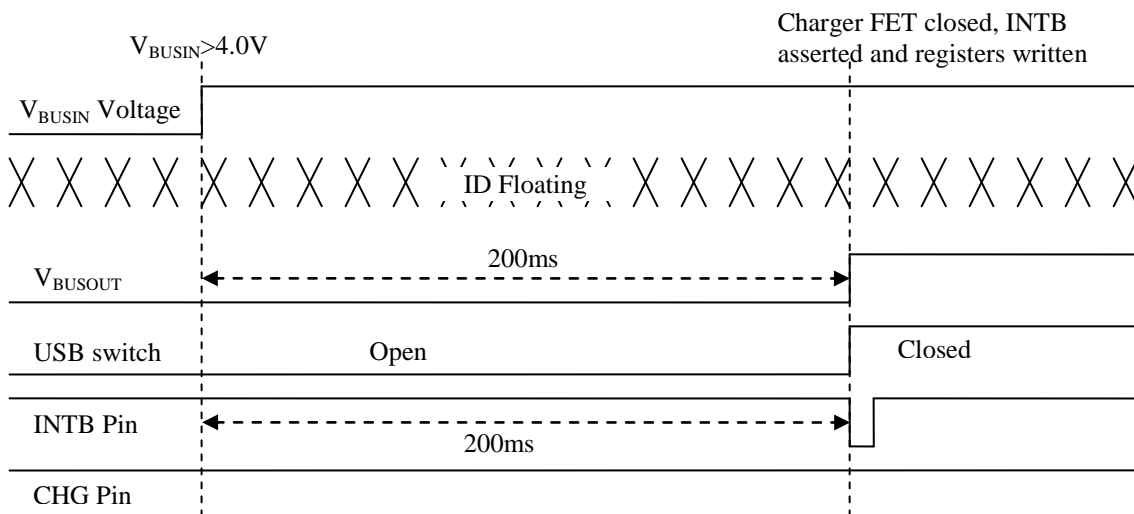

**Figure 7. Apple Chargers (1A/2A/2.4A) Attach Timing**

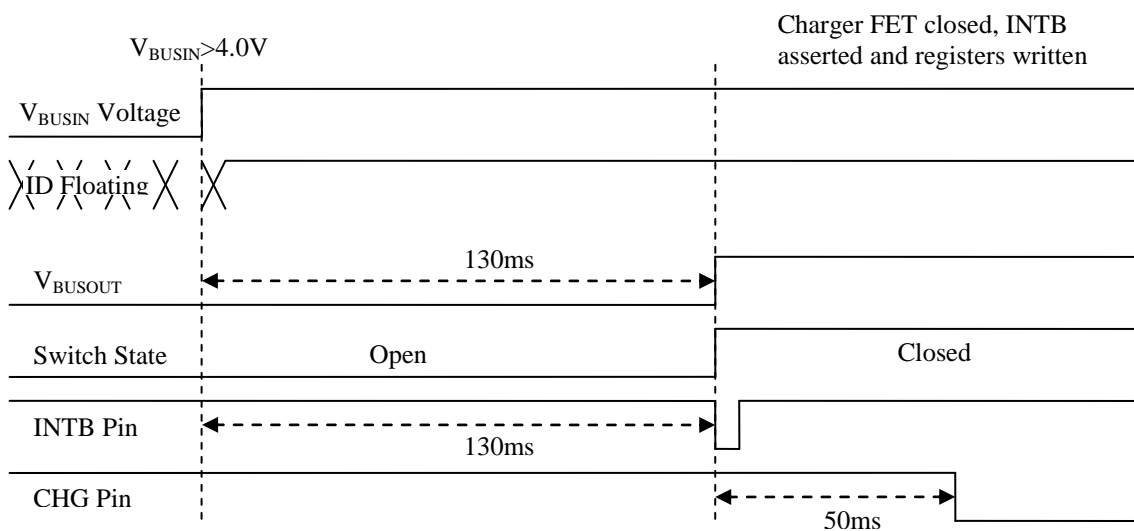

**Figure 8. Car Kit Type 1 and 2 Timing**

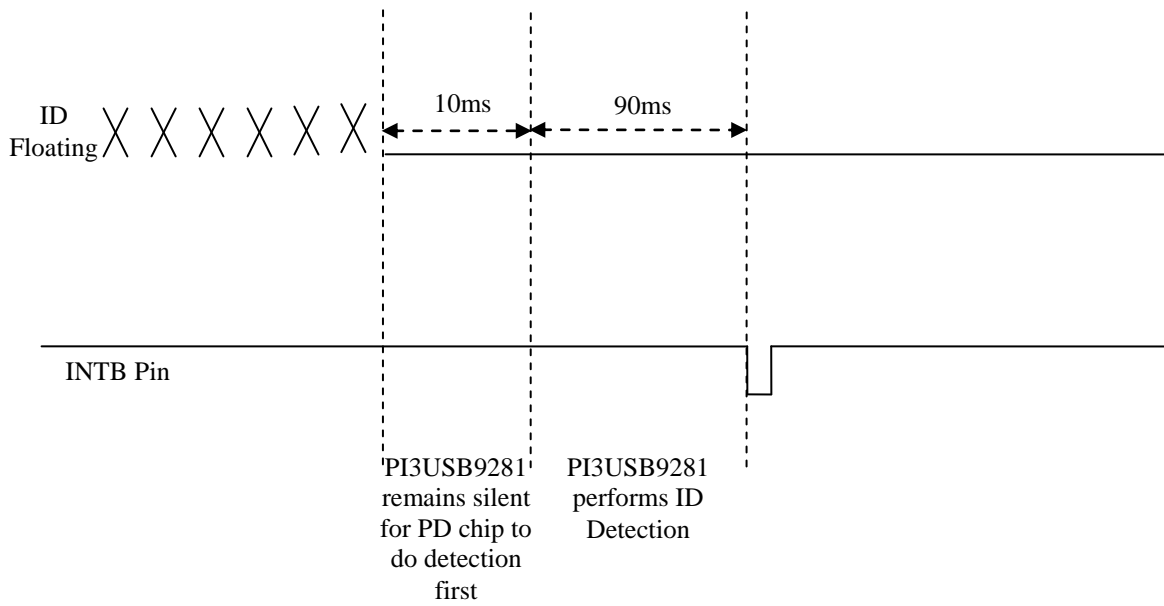

**Figure 9. USB Power Delivery (PD) Cables and Other Accessories Detection Timing**

**TYPICAL CHARACTERISTICS**

Frequency response curve for USB switch channel (D+ to DPH, 3db BW=1.3G)

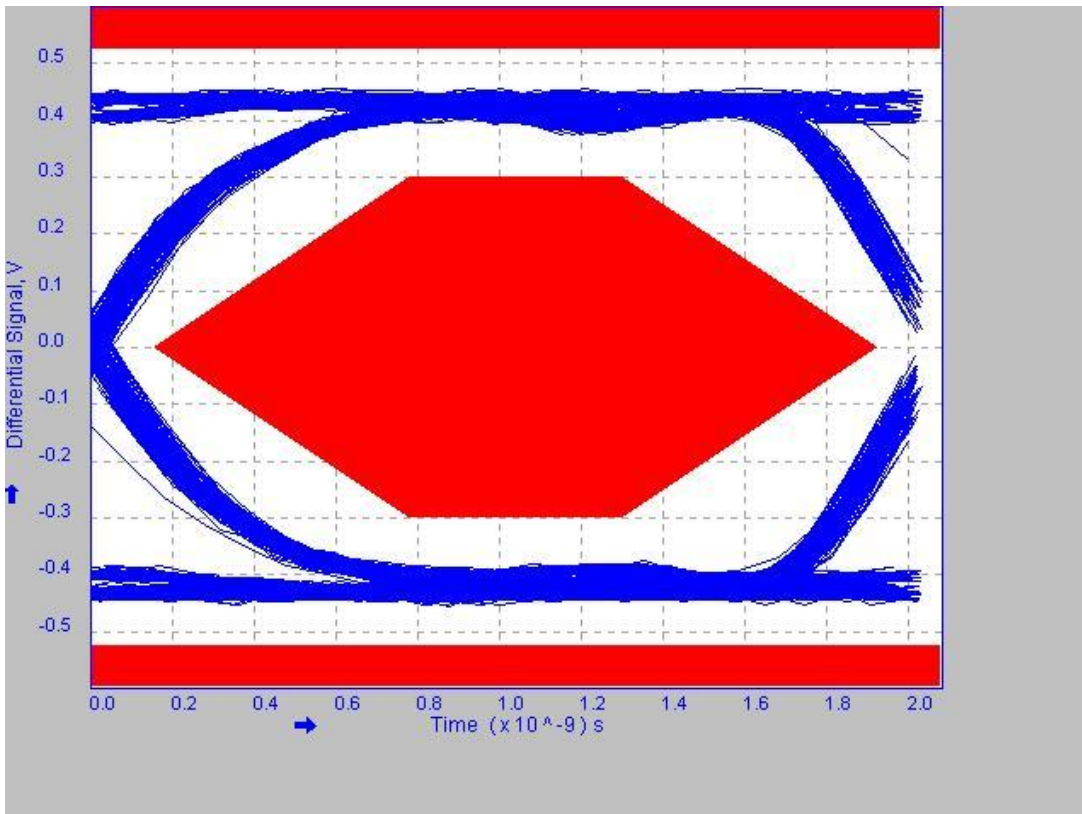
**Eye diagram for USB 2.0 High Speed**

## Mechanical Information

CSP 1.5 x 2.0-15L

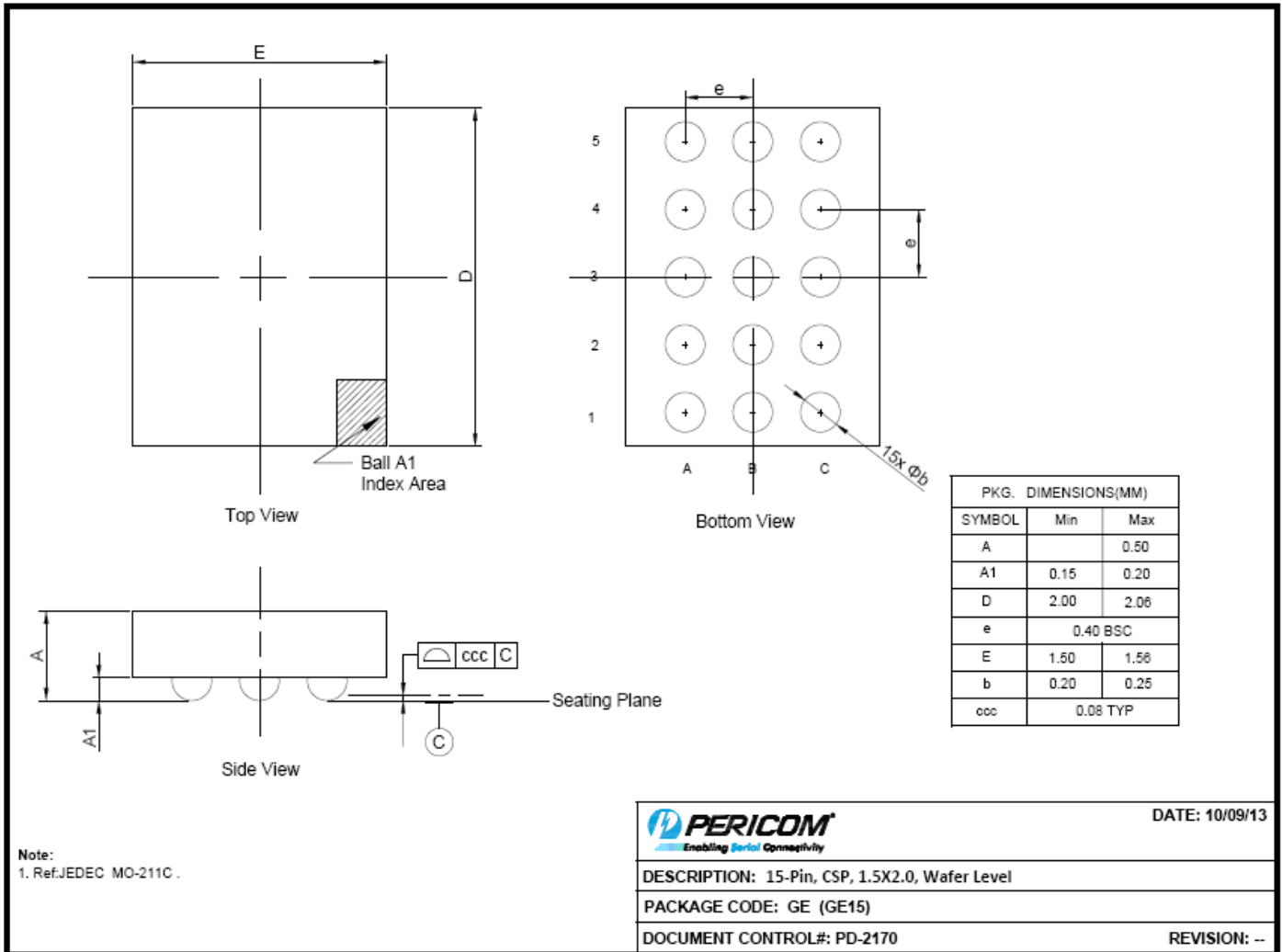

## Ordering Information

Part No.	Package Code	Package
PI3USB9281GEE	GE	15-Pin CSP 1.5 x 2.0

**Note:**

- E = Pb-free or Pb-free and Green
- Adding X Suffix= Tape/Reel

Pericom Semiconductor Corporation • 1-800-435-2336 • [www.pericom.com](http://www.pericom.com)

Pericom reserves the right to make changes to its products or specifications at any time, without notice, in order to improve design or performance and to supply the best possible product. Pericom does not assume any responsibility for use of any circuitry described other than the circuitry embodied in Pericom product. The company makes no representations that circuitry described herein is free from patent infringement or other rights, of Pericom.

单击下面可查看定价，库存，交付和生命周期等信息

[>>Diodes Incorporated\(达达科技\(美台\)\)](#)