

ZXMP4A16K

40V P-channel enhancement mode MOSFET

Summary

$V_{(BR)DSS} = -40V$; $R_{DS(ON)} = 0.060\Omega$ $I_D = -9.9A$

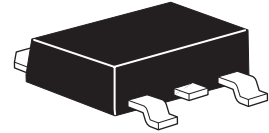

Description

This new generation of trench MOSFETs from Zetex utilizes a unique structure that combines the benefits of low on-resistance with fast switching speed. This makes them ideal for high efficiency, low voltage, power management applications.

Features

- Low on-resistance
- Fast switching speed
- Low threshold
- Low gate drive
- DPAK package

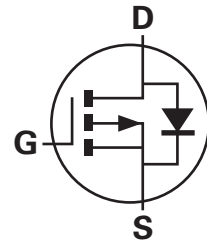

Applications

- DC - DC converters
- Audio output stages
- Relay and solenoid driving
- Motor control

Ordering information

Device	Reel size (inches)	Tape width	Quantity per reel
ZXMP4A16KTC	13	16mm	2500 units

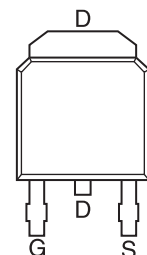

Pinout - Top view

Device marking

ZXMP
4A16

Absolute maximum rating

Parameter	Symbol	Limit	Unit
Drain-source voltage	V_{DSS}	-40	V
Gate-source voltage	V_{GS}	± 20	V
Continuous drain current $V_{GS} = -10V; T_A = 25^\circ C$ ^(b) $V_{GS} = -10V; T_A = 70^\circ C$ ^(b) $V_{GS} = -10V; T_A = 25^\circ C$ ^(a)	I_D	-9.9 -8.0 -6.6	A A A
Pulsed drain current ^(c)	I_{DM}	-35	A
Continuous source current (body diode) ^(b)	I_S	-10.1	A
Pulsed source current (body diode) ^(c)	I_{SM}	-35	A
Power dissipation at $T_A = 25^\circ C$ ^(a) Linear derating factor	P_D	4.2 33.6	W mW/°C
Power dissipation at $T_A = 25^\circ C$ ^(b) Linear derating factor	P_D	9.5 76	W mW/°C
Power dissipation at $T_A = 25^\circ C$ ^(d) Linear derating factor	P_D	2.15 17.2	W mW/°C
Operating and storage temperature range	$T_j; T_{stg}$	-55 to +150	°C
Thermal resistance			
Parameter	Symbol	Value	Unit
Junction to ambient ^(a)	$R_{\theta JA}$	30	°C/W
Junction to ambient ^(b)	$R_{\theta JA}$	13.2	°C/W
Junction to ambient ^(d)	$R_{\theta JA}$	58	°C/W

NOTES:

- (a) For a device surface mounted on 50mm x 50mm x 1.6mm FR4 PCB with high coverage of single sided 2oz copper, in still air conditions.
- (b) For a device surface mounted on FR4 PCB measured at $t \leq 10$ sec.
- (c) Repetitive rating 50mm x 50mm x 1.6mm FR4 PCB, $D=0.02$ pulse width=300 μ s - pulse width limited by maximum junction temperature.
- (d) For a device surface mounted on 25mm x 25mm x 1.6mm FR4 PCB with high coverage of single sided 1oz copper, in still air conditions.

Characteristics

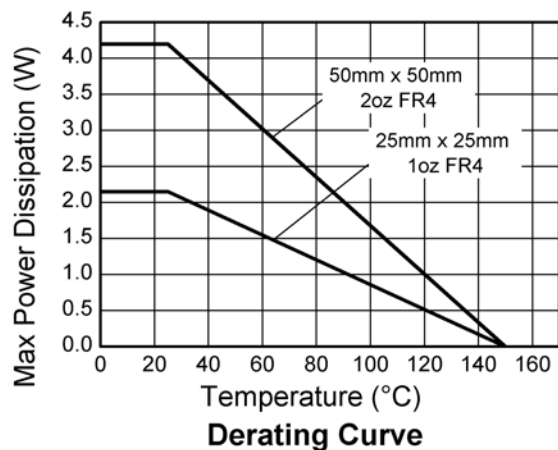
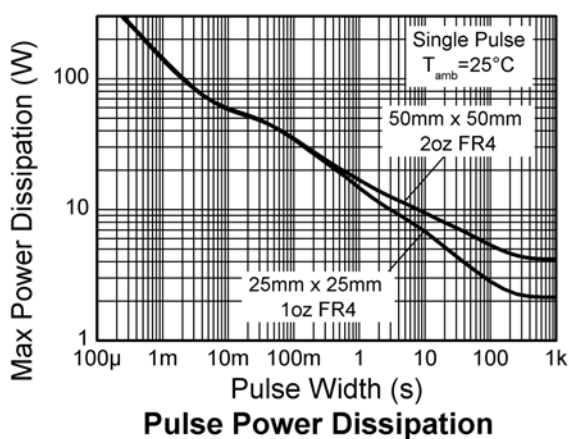
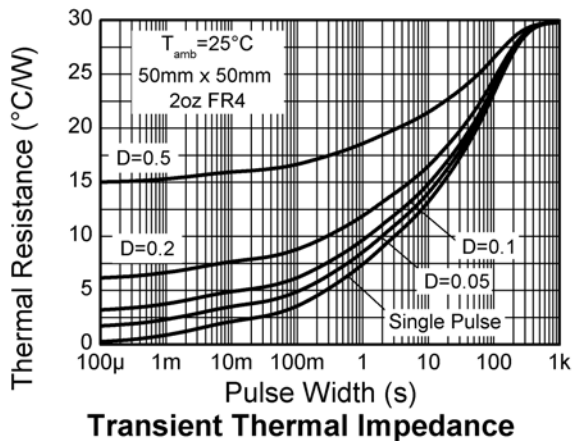
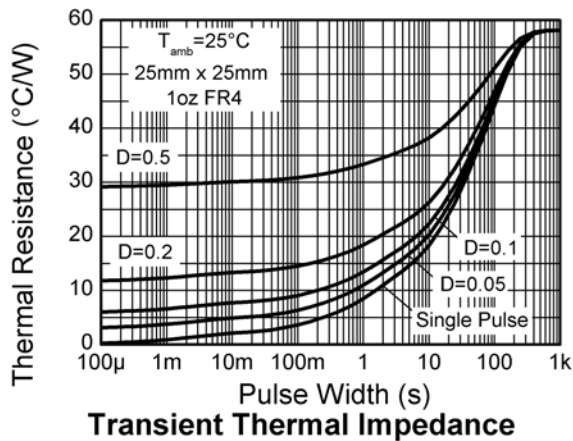
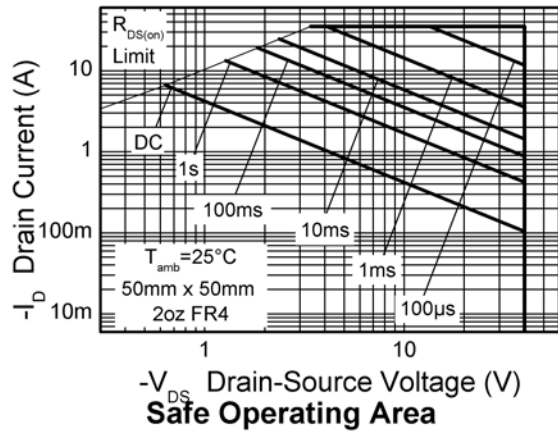
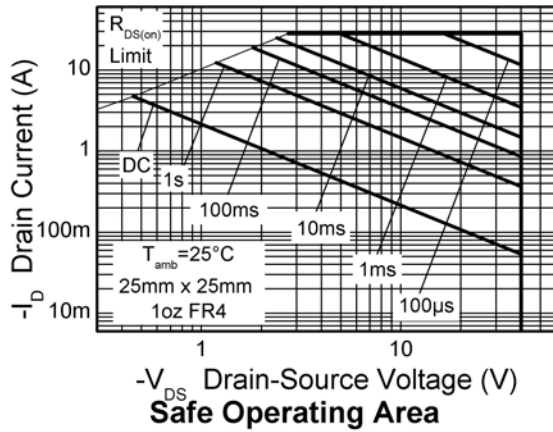

ZXMP4A16K

Electrical characteristics (at $T_A = 25^\circ\text{C}$ unless otherwise stated)

Parameter	Symbol	Min.	Typ.	Max.	Unit	Conditions
Static						
Drain-source breakdown voltage	$V_{(BR)DSS}$	-40			V	$I_D = -250\mu\text{A}$, $V_{GS} = 0\text{V}$
Zero gate voltage drain current	I_{DSS}			-1	μA	$V_{DS} = -40\text{V}$, $V_{GS} = 0\text{V}$
Gate-body leakage	I_{GSS}			100	nA	$V_{GS} = \pm 20\text{V}$, $V_{DS} = 0\text{V}$
Gate-source threshold voltage	$V_{GS(th)}$	-1.0			V	$I_D = -250\mu\text{A}$, $V_{DS} = V_{GS}$
Static drain-source on-state resistance (*)	$R_{DS(on)}$			0.060	Ω	$V_{GS} = -10\text{V}$, $I_D = -3.8\text{A}$
				0.100	Ω	$V_{GS} = -4.5\text{V}$, $I_D = -2.9\text{A}$
Forward transconductance (*)(‡)	g_{fs}		7.4		S	$V_{DS} = -15\text{V}$, $I_D = -3.8\text{A}$
Dynamic (‡)						
Input capacitance	C_{iss}		965		pF	$V_{DS} = -20\text{V}$, $V_{GS} = 0\text{V}$, $f = 1\text{MHz}$
Output capacitance	C_{oss}		180		pF	
Reverse transfer capacitance	C_{rss}		158		pF	
Switching (†) (‡)						
Turn-on delay time	$t_{d(on)}$		4.0		ns	$V_{DD} = -20\text{V}$, $I_D = -1\text{A}$ $R_G = 6.0\Omega$, $V_{GS} = -10\text{V}$
Rise time	t_r		6.0		ns	
Turn-off delay time	$t_{d(off)}$		36.8		ns	
Fall time	t_f		17.1		ns	
Gate charge	Q_g		16.5		nC	$V_{DS} = -20\text{V}$, $V_{GS} = -5\text{V}$, $I_D = -3.8\text{A}$
Total gate charge	Q_g		29.6		nC	$V_{DS} = -20\text{V}$, $V_{GS} = -10\text{V}$, $I_D = -3.8\text{A}$
Gate-source charge	Q_{gs}		2.8		nC	
Gate-drain charge	Q_{gd}		8.1		nC	
Source-drain diode						
Diode forward voltage (*)	V_{SD}		-0.89	-1.2	V	$T_J = 25^\circ\text{C}$, $I_S = -3.8\text{A}$, $V_{GS} = 0\text{V}$
Reverse recovery time (‡)	t_{rr}		29.8		ns	$T_J = 25^\circ\text{C}$, $I_F = -3.8\text{A}$, $di/dt = 100\text{A}/\mu\text{s}$
Reverse recovery charge (‡)	Q_{rr}		37.2		nC	

NOTES:

(*) Measured under pulsed conditions. Width $\leq 300\mu\text{s}$. Duty cycle $\leq 2\%$.

(†) Switching characteristics are independent of operating junction temperature.

(‡) For design aid only, not subject to production testing.

Typical characteristics

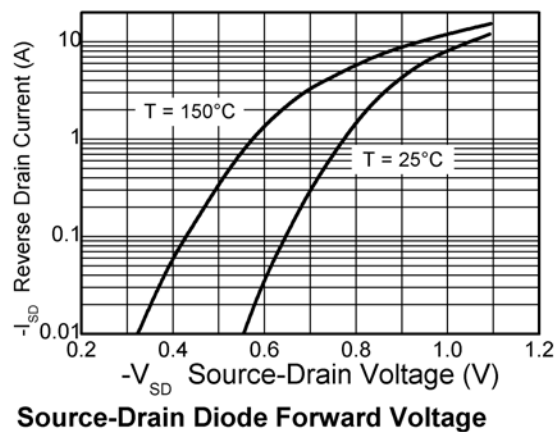
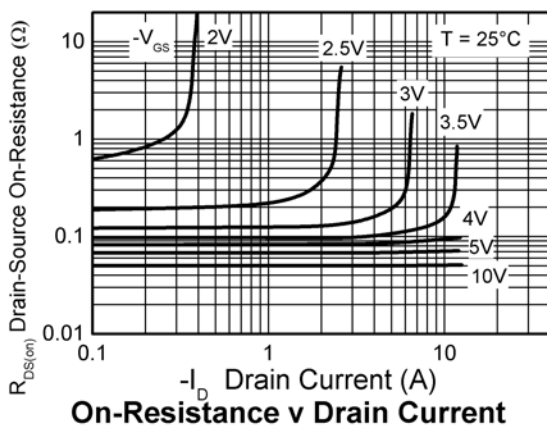
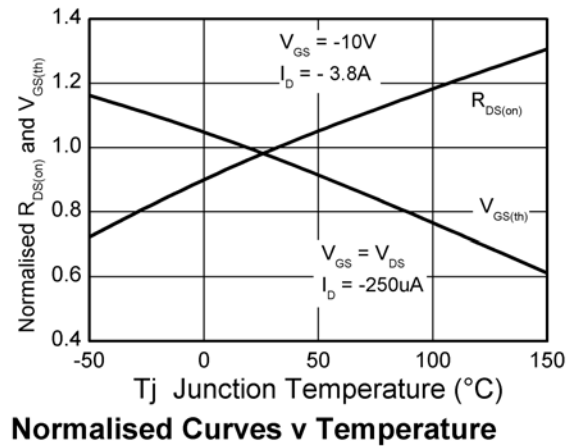
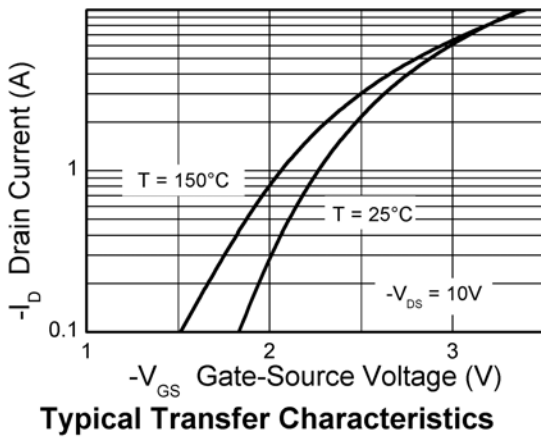
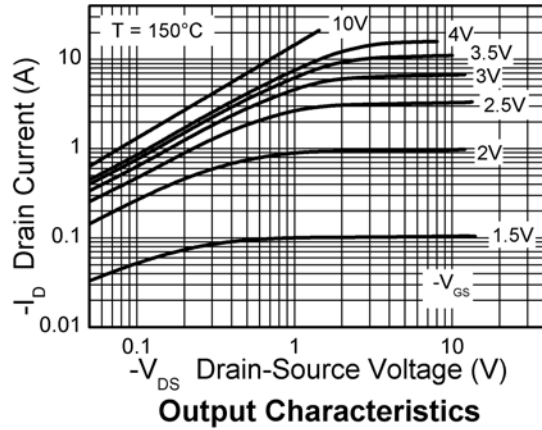
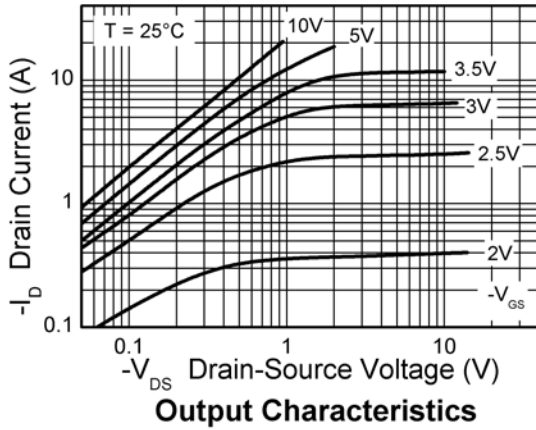

Typical characteristics

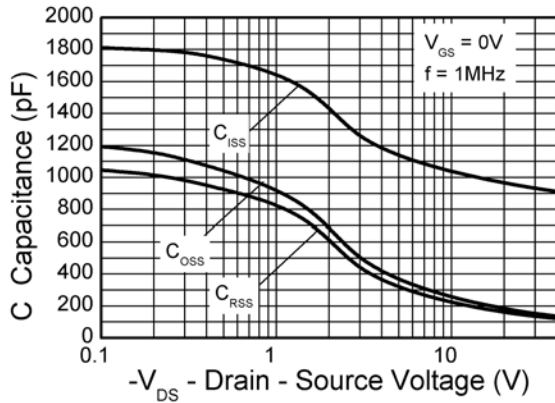

Capacitance v Drain-Source Voltage

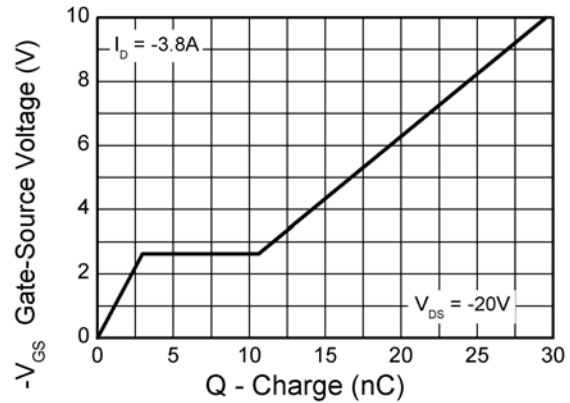

Gate-Source Voltage v Gate Charge

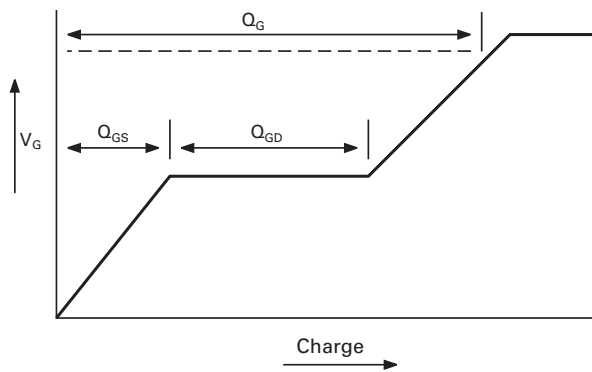

Basic gate charge waveform

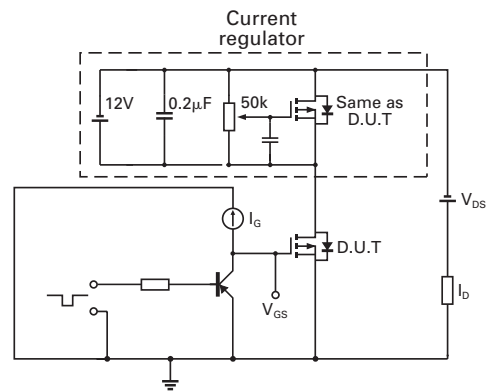

Gate charge test circuit

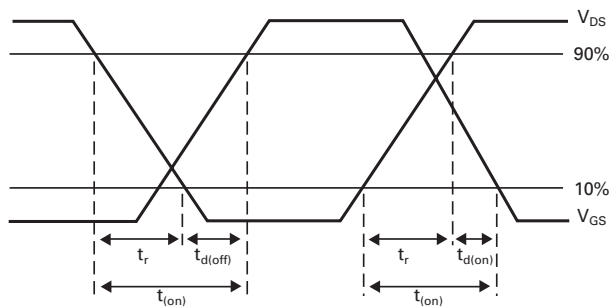

Switching time waveforms

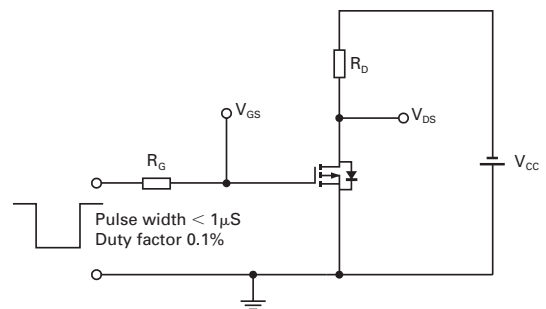

Switching time test circuit

ZXMP4A16K

Intentionally left blank

ZXMP4A16K

Package details - DPAK

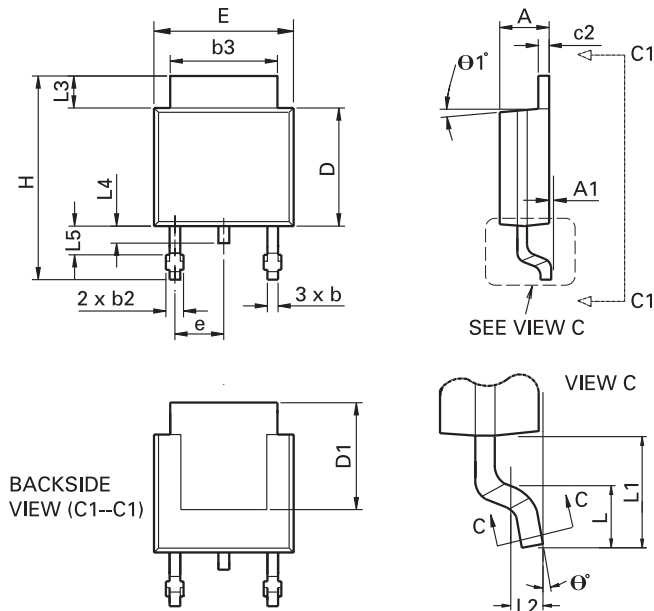

Package dimensions

Dim.	Inches		Millimeters		Dim.	Inches		Millimeters	
	Min.	Max.	Min.	Max.		Min.	Max.	Min.	Max.
A	0.086	0.094	2.18	2.39	e	0.090 BSC		2.29 BSC	
A1	-	0.005	-	0.127	H	0.370	0.410	9.40	10.41
b	0.020	0.035	0.508	0.89	L	0.055	0.070	1.40	1.78
b2	0.030	0.045	0.762	1.14	L1	0.108 REF		2.74 REF	
b3	0.205	0.215	5.21	5.46	L2	0.020 BSC		0.508 BSC	
c	0.018	0.024	0.457	0.61	L3	0.035	0.065	0.89	1.65
c2	0.018	0.023	0.457	0.584	L4	0.025	0.040	0.635	1.016
D	0.213	0.245	5.41	6.22	L5	0.045	0.060	1.14	1.52
D1	0.205	-	5.21	-	theta 1°	0°	10°	0°	10°
E	0.250	0.265	6.35	6.73	theta °	0°	15°	0°	15°
E1	0.170	-	4.32	-	-	-	-	-	-

Note: Controlling dimensions are in inches. Approximate dimensions are provided in millimeters

Europe	Americas	Asia Pacific	Corporate Headquarters
Zetex GmbH Streitfeldstraße 19 D-81673 München Germany	Zetex Inc 700 Veterans Memorial Highway Hauppauge, NY 11788 USA	Zetex (Asia Ltd) 3701-04 Metroplaza Tower 1 Hing Fong Road, Kwai Fong Hong Kong	Zetex Semiconductors plc Zetex Technology Park, Chadderton Oldham, OL9 9LL United Kingdom
Telefon: (49) 89 45 49 49 0 Fax: (49) 89 45 49 49 49 europe.sales@zetex.com	Telephone: (1) 631 360 2222 Fax: (1) 631 360 8222 usa.sales@zetex.com	Telephone: (852) 26100 611 Fax: (852) 24250 494 asia.sales@zetex.com	Telephone: (44) 161 622 4444 Fax: (44) 161 622 4446 hq@zetex.com

For international sales offices visit www.zetex.com/offices

Zetex products are distributed worldwide. For details, see www.zetex.com/salesnetwork

This publication is issued to provide outline information only which (unless agreed by the company in writing) may not be used, applied or reproduced for any purpose or form part of any order or contact or be regarded as a representation relating to the products or services concerned. The company reserves the right to alter without notice the specification, design, price or conditions of supply of any product or service.

单击下面可查看定价，库存，交付和生命周期等信息

[>>Diodes Incorporated\(达达科技\(美台\)\)](#)