

## Product Summary

- Continuous Drain Source Voltage:  $V_{DS} = 60V$
- On-State Resistance:  $675m\Omega$
- Max Nominal Load Current ( $V_{IN} = 5V$ ): 1.1A
- Min Nominal Load Current ( $V_{IN} = 5V$ ): 0.7A
- Clamping Energy: 550mJ

## Description

The ZXMS6001N3Q is a low input current self-protected low-side IntelliFET™ MOSFET intended for  $V_{IN} = 5V$  applications. It features monolithic overtemperature, overcurrent, overvoltage (active clamp) and ESD protected logic level functionality. It is intended as a general purpose switch.

## Applications

- Especially Suited for Loads with a High In-rush Current Such as Lamps and Motors
- All Types of Resistive, Inductive and Capacitive Loads in Switching Applications
- $\mu C$  Compatible Power Switch for 12V and 24V DC Applications
- Automotive Rated
- Replaces Electromechanical Relays and Discrete Circuits
- Linear Mode Capability: the current-limiting protection circuitry is designed to deactivate at low  $V_{DS}$  to minimize on-state power dissipation. The maximum DC operating current is therefore determined by the thermal capability of the package/board combination, rather than by the protection circuitry. This does not compromise the product's ability to self-protect at low  $V_{DS}$ .

## Features and Benefits

- Low Input Current
- Short Circuit Protection with Auto Restart
- Overvoltage Protection (Active Clamp)
- Thermal Shutdown with Auto Restart
- Overcurrent Protection
- Input Protection (ESD)
- Load Dump Protection (Actively Protects Load)
- **Lead-Free Finish; RoHS Compliant (Notes 1 & 2)**
- **Halogen and Antimony Free. "Green" Device (Note 3)**
- **Qualified to AEC-Q101 Standards for High Reliability**
- **PPAP Capable (Note 4)**

## Mechanical Data

- Case: SOT223 (Type DN)
- Case Material: Molded Plastic, "Green" Molding Compound. UL Flammability Classification Rating 94V-0
- Moisture Sensitivity: Level 1 per J-STD-020
- Terminals: Matte Tin Finish **e3**
- Weight: 0.112 grams (Approximate)

SOT223 (Type DN)

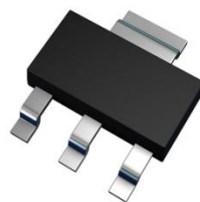

Top View

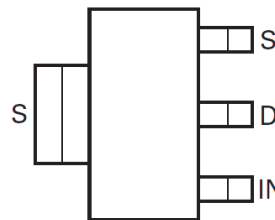

Top View  
Pin Out

Note: The tab is connected to the source pin and must be electrically isolated from the drain pin. Connection of significant copper to the drain pin is recommended for best thermal performance.

## Ordering Information (Note 5)

Part Number	Marking	Reel Size (inches)	Tape Width (mm)	Quantity per Reel
ZXMS6001N3QTA	ZXMS6001	7	12	1,000 Units

- Notes:
1. EU Directive 2002/95/EC (RoHS), 2011/65/EU (RoHS 2) & 2015/863/EU (RoHS 3) compliant. All applicable RoHS exemptions applied.
  2. See <https://www.diodes.com/quality/lead-free/> for more information about Diodes Incorporated's definitions of Halogen- and Antimony-free, "Green" and Lead-free.
  3. Halogen- and Antimony-free "Green" products are defined as those which contain <900ppm bromine, <900ppm chlorine (<1500ppm total Br + Cl) and <1000ppm antimony compounds.
  4. Automotive products are AEC-Q101 qualified and are PPAP capable. Please refer to <https://www.diodes.com/quality/>.
  5. For packaging details, go to our website at <https://www.diodes.com/design/support/packaging/diodes-packaging/>.

**Marking Information**

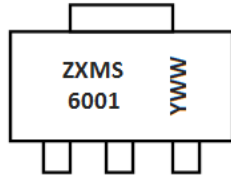

ZXMS6001 = Product Type Marking Code  
 YWW = Date Code Marking  
 Y or  $\bar{Y}$  = Last Digit of Year (ex: 8 = 2018)  
 WW or  $\bar{W}W$  = Week Code (01 to 53)

**Functional Block Diagram**

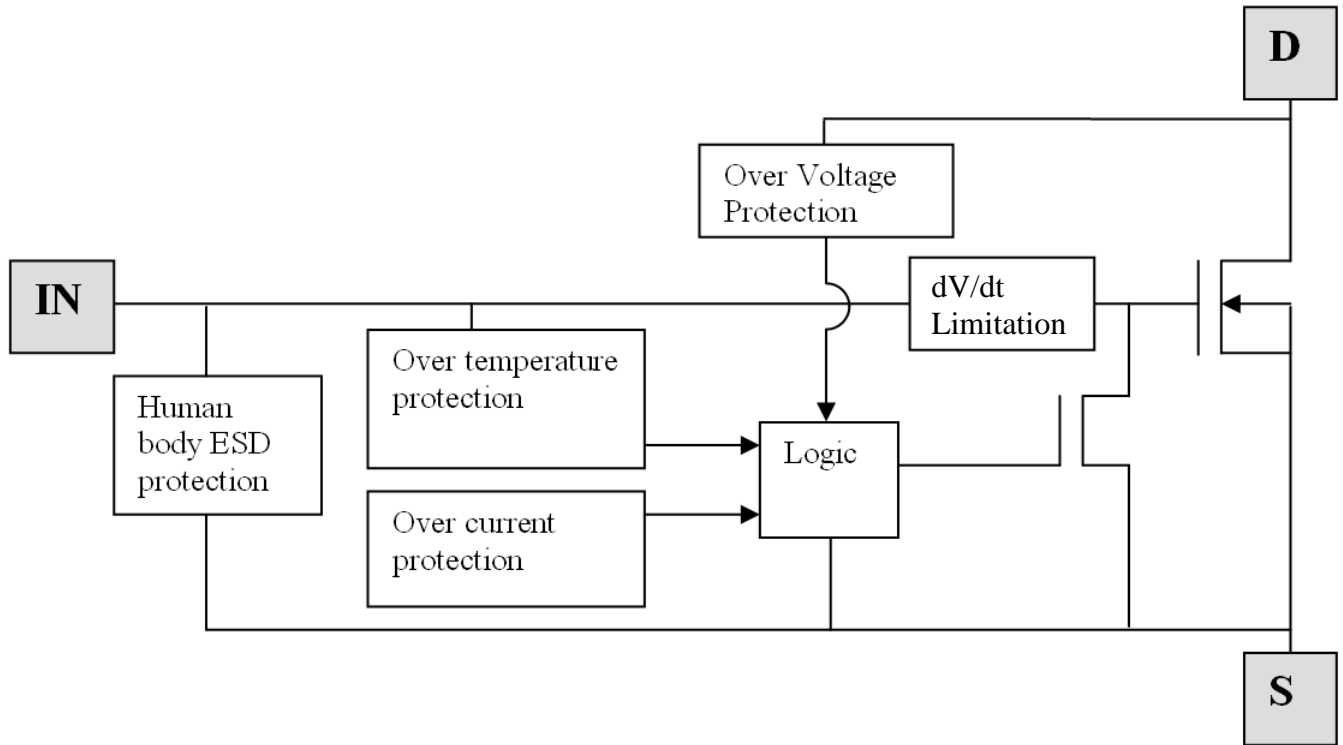

**Absolute Maximum Ratings** (@T<sub>A</sub> = +25°C, unless otherwise stated.)

Characteristic	Symbol	Value	Unit
Continuous Drain-Source Voltage	V <sub>DS</sub>	60	V
Drain-Source Voltage for Short Circuit Protection V <sub>IN</sub> = 5V	V <sub>DS(SC)</sub>	36	V
Continuous Input Voltage	V <sub>IN</sub>	-0.2 to +10	V
Peak Input Voltage	V <sub>IN</sub>	-0.2 to +20	V
Continuous Input Current -0.2V ≤ V <sub>IN</sub> ≤ 10V V <sub>IN</sub> < -0.2V or V <sub>IN</sub> > 10V	I <sub>IN</sub>	No Limit   I <sub>IN</sub>   ≤ 2	mA
Operating Temperature Range	T <sub>J</sub>	-40 to +150	°C
Storage Temperature Range	T <sub>STG</sub>	-55 to +150	°C
Power Dissipation at T <sub>A</sub> = +25°C (Note 6)	P <sub>D</sub>	1.5	W
Power Dissipation at T <sub>A</sub> = +25°C (Note 8)	P <sub>D</sub>	0.6	W
Continuous Drain Current @ V <sub>IN</sub> = 5V; T <sub>A</sub> = +25°C (Note 6)	I <sub>D</sub>	1.1	A
Continuous Drain Current @ V <sub>IN</sub> = 5V; T <sub>A</sub> = +25°C (Note 8)	I <sub>D</sub>	0.7	A
Continuous Source Current (Body Diode) (Note 6)	I <sub>S</sub>	2.0	A
Pulsed Source Current (Body Diode) (Note 7)	I <sub>S</sub>	3.3	A
Unclamped Single Pulse Inductive Energy	E <sub>AS</sub>	550	mJ
Load Dump Protection	V <sub>LOADDUMP</sub>	80	V
Electrostatic Discharge (Human Body Model)	V <sub>ESD</sub>	4,000	V
DIN Humidity Category, DIN 40 040	—	E	—
IEC Climatic Category, DIN IEC 68-1	—	40/150/56	—

**Thermal Resistance**

Characteristic	Symbol	Value	Unit
Junction to Ambient (Note 6)	R <sub>θJA</sub>	83	°C/W
Junction to Ambient (Note 7)	R <sub>θJA</sub>	45	°C/W
Junction to Ambient (Note 8)	R <sub>θJA</sub>	208	°C/W

**Recommended Operating Conditions**

The ZXMS6001N3Q is optimized for use with μC operating from 5V supplies.

Characteristic	Symbol	Min	Max	Unit
Input Voltage Range	V <sub>IN</sub>	0	6	V
Ambient Temperature Range	T <sub>A</sub>	-40	+125	°C
High Level Input Voltage for MOSFET (Note 9)	V <sub>IH</sub>	4	6	V
Peripheral Supply Voltage (Voltage to which Load is Referred)	V <sub>P</sub>	—	60	V

- Notes:
6. For a device surface mounted on 25mm x 25mm x 1.6mm FR-4 board with a high coverage of single sided 2oz weight copper. Allocation of 6cm<sup>2</sup> copper 33% to source tab and 66% to drain pin with source tab and drain pin electrically isolated.
  7. For a device surface mounted on FR-4 board as (Note 6) and measured at t<=10s.
  8. For a device surface mounted on FR-4 board with the minimum copper required for electrical connections.
  9. Recommended input voltage range over which protection circuits function as specified.

**Electrical Characteristics** (@T<sub>A</sub> = +25°C, unless otherwise stated.)

Characteristic	Symbol	Min	Typ	Max	Unit	Conditions
<b>Static Characteristics</b>						
Drain-Source Clamp Voltage	V <sub>DS(AZ)</sub>	60	70	75	V	I <sub>D</sub> = 10mA
Off State Drain Current	I <sub>DSS</sub>	—	0.1	3	μA	V <sub>DS</sub> = 12V, V <sub>IN</sub> = 0V
Off State Drain Current	I <sub>DSS</sub>	—	3	15	μA	V <sub>DS</sub> = 32V, V <sub>IN</sub> = 0V
Input Threshold Voltage (Note 9)	V <sub>IN(TH)</sub>	1	1.8	2.5	V	V <sub>DS</sub> = V <sub>GS</sub> , I <sub>D</sub> = 10mA
Input Current	I <sub>IIN</sub>	—	150	—	μA	V <sub>IN</sub> = +3V
Input Current	I <sub>IIN</sub>	—	335	500	μA	V <sub>IN</sub> = +5V, All Circumstances
Static Drain-Source On-State Resistance	R <sub>DS(ON)</sub>	—	1	2	Ω	V <sub>IN</sub> = 3V, I <sub>D</sub> = 0.1A
Static Drain-Source On-State Resistance	R <sub>DS(ON)</sub>	—	520	675	mΩ	V <sub>IN</sub> = 5V, I <sub>D</sub> = 0.7A
Current Limit (Note 10)	I <sub>D(LIM)</sub>	1	1.8	3	A	V <sub>IN</sub> = 5V, V <sub>DS</sub> > 5V
<b>Dynamic Characteristics</b>						
Turn-On Time (V <sub>IN</sub> to 90% I <sub>D</sub> )	t <sub>ON</sub>	—	27	—	μs	R <sub>L</sub> = 22Ω, V <sub>IN</sub> = 0 to 5V, V <sub>DD</sub> = 12V
Turn-Off Time (V <sub>IN</sub> to 90% I <sub>D</sub> )	t <sub>OFF</sub>	—	26	—	μs	R <sub>L</sub> = 22Ω, V <sub>IN</sub> = 5V to 0V, V <sub>DD</sub> = 12V
Slew Rate On (70 to 50% V <sub>DD</sub> )	dV <sub>DS</sub> /dt <sub>ON</sub>	—	1.4	—	V/μs	R <sub>L</sub> = 22Ω, V <sub>IN</sub> = 0 to 5V, V <sub>DD</sub> = 12V
Slew Rate Off (50 to 70% V <sub>DD</sub> )	dV <sub>DS</sub> /dt <sub>ON</sub>	—	1.2	—	V/μs	R <sub>L</sub> = 22Ω, V <sub>IN</sub> = 5V to 0V, V <sub>DD</sub> = 12V
<b>Protection Functions (Note 11)</b>						
Minimum Input Voltage for Over-Temperature Protection (Note 12)	V <sub>PROT(MIN)</sub>	—	3.5	4	V	T <sub>TRIP</sub> > +150°C
Maximum Input Voltage for Over-Temperature Protection (Note 12)	V <sub>PROT(MAX)</sub>	6	7	—	V	T <sub>TRIP</sub> > +150°C
Thermal Overload Trip Temperature	T <sub>JT</sub>	+150	+175	—	°C	—
Thermal Hysteresis	—	—	+8	—	°C	—
Unclamped Single Pulse Inductive Energy T <sub>J</sub> = +25°C	E <sub>AS</sub>	550	—	—	mJ	I <sub>D(ISO)</sub> = 0.7A, V <sub>DD</sub> = 32V
Unclamped Single Pulse Inductive Energy T <sub>J</sub> = +150°C	E <sub>AS</sub>	200	—	—	mJ	I <sub>D(ISO)</sub> = 0.7A, V <sub>DD</sub> = 32V
<b>Inverse Diode</b>						
Source Drain Voltage	V <sub>SD</sub>	—	—	1	V	V <sub>IN</sub> = 0V, -I <sub>D</sub> = 1.4A

- Notes:
- Recommended input voltage range over which protection circuits function as specified.
  - The drain current is limited to a reduced value when V<sub>DS</sub> exceeds a safe level.
  - Integrated protection functions are designed to prevent IC destruction under fault conditions described in the datasheet. Fault conditions are considered as "outside" normal operating range. Protection functions are not designed for continuous, repetitive operation.
  - Not subject to production test, specified by design.

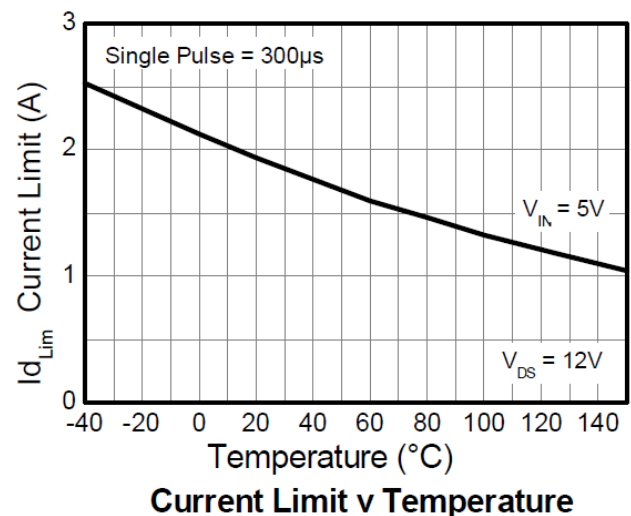
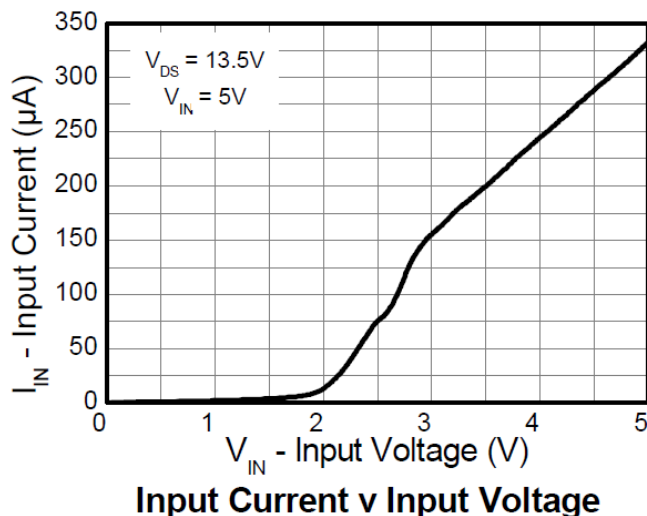

## Application Information

The current-limit protection circuitry is designed to de-activate at low  $V_{DS}$  to prevent the load current from being unnecessarily restricted during normal operation. The design max DC operating current is therefore determined by the thermal capability of the package/board combination, rather than by the protection circuitry (see graph 'typical output characteristic'). This does not compromise the products ability to self-protect at low  $V_{DS}$ .

The overtemperature protection circuit trips at a minimum of +150°C. So the available package dissipation reduces as the maximum required ambient temperature increases. This leads to the following maximum recommended continuous operating currents.

## Minimum Copper Area Characteristics

For minimum copper condition as described in Note 8.

Max Ambient Temperature $T_A$	Maximum Continuous Current $V_{IN} = 5V$
+25°C at $V_{IN} = 5V$	720
+70°C at $V_{IN} = 5V$	575
+85°C at $V_{IN} = 5V$	520
+125°C at $V_{IN} = 5V$	320

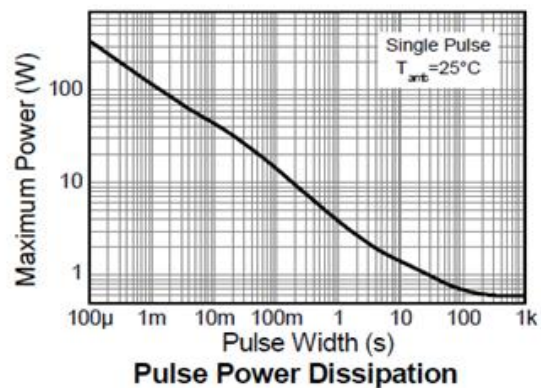
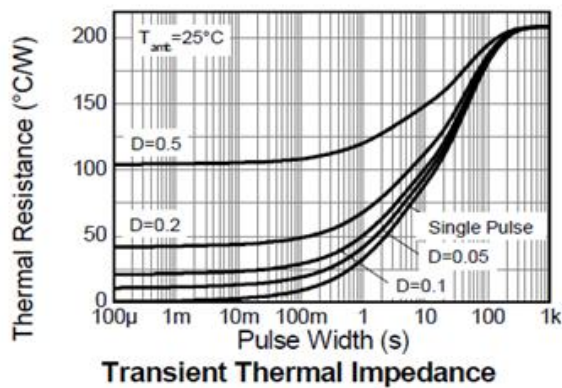
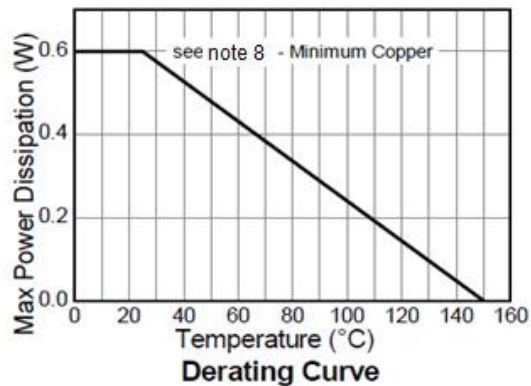
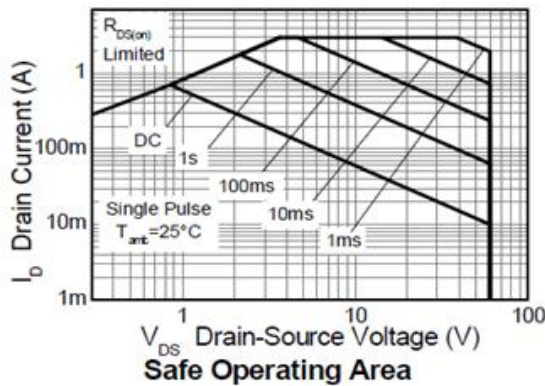

**Large Copper Area Characteristics**

For large copper area as described in Note 6.

Max Ambient Temperature $T_A$	Maximum Continuous Current $V_{IN} = 5V$
+25°C at $V_{IN} = 5V$	1,140
+70°C at $V_{IN} = 5V$	915
+85°C at $V_{IN} = 5V$	825
+125°C at $V_{IN} = 5V$	510

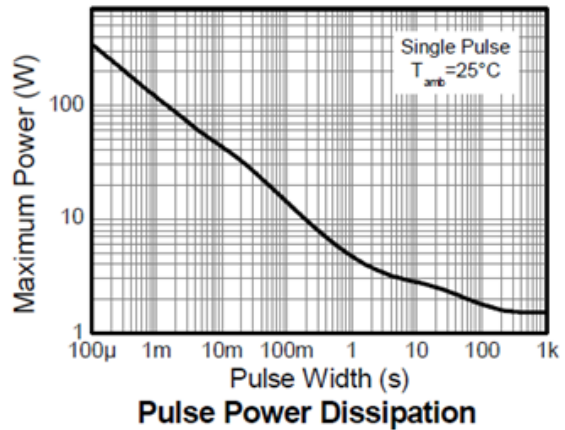
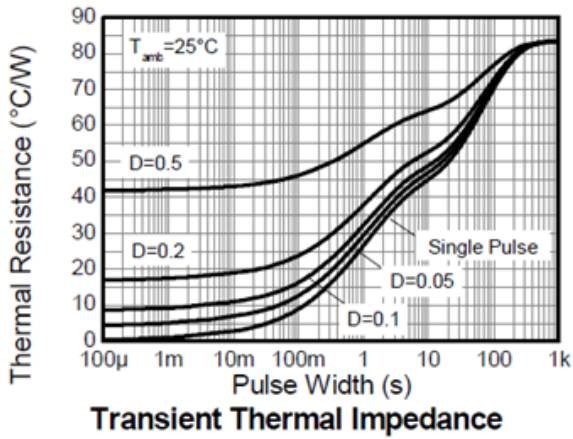
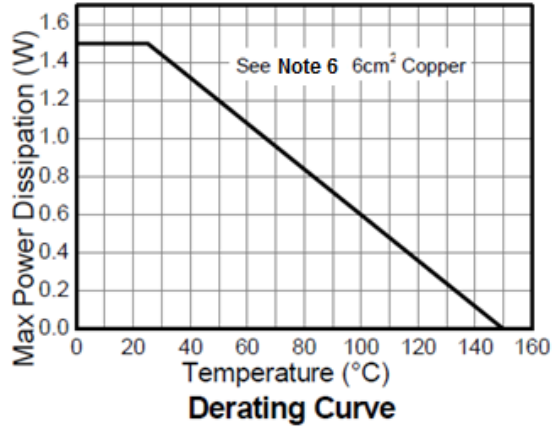
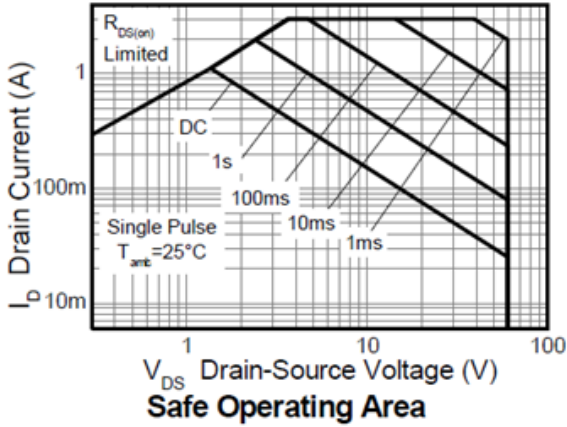

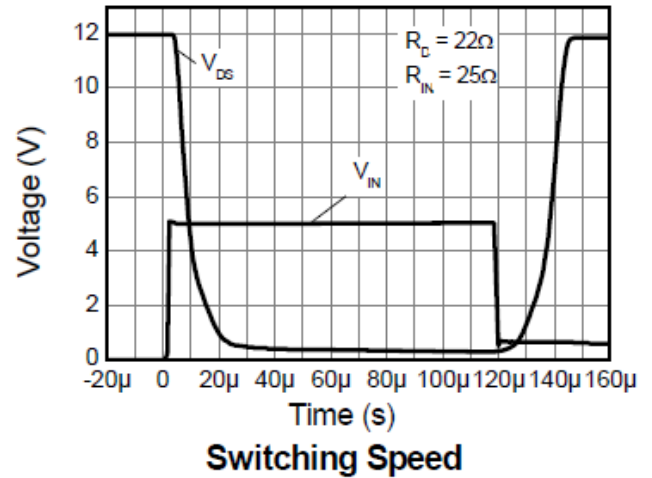
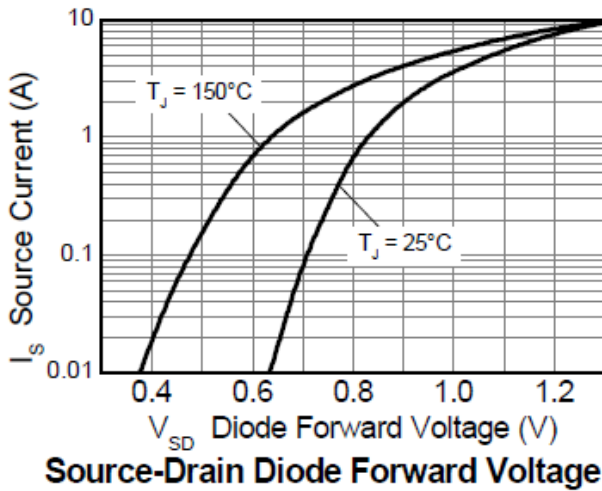
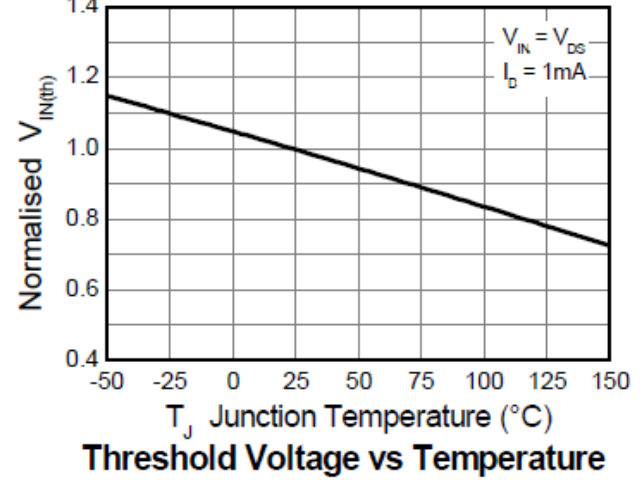
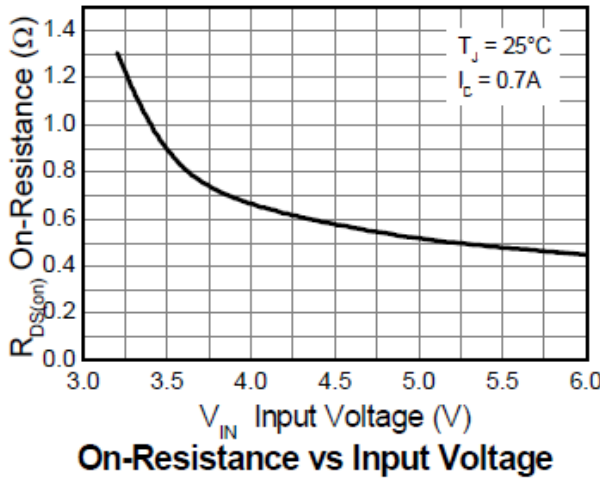
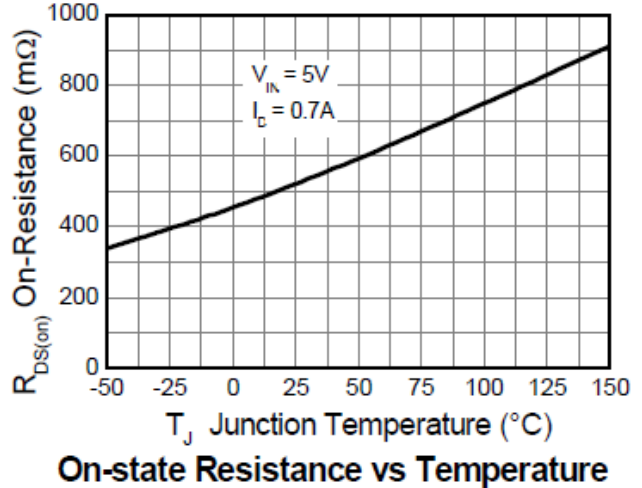
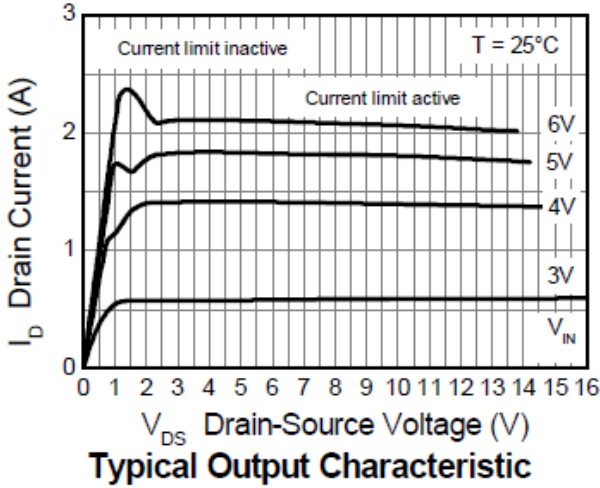

**Package Outline Dimensions**

Please see <http://www.diodes.com/package-outlines.html> for the latest version.

**SOT223 (Type DN)**

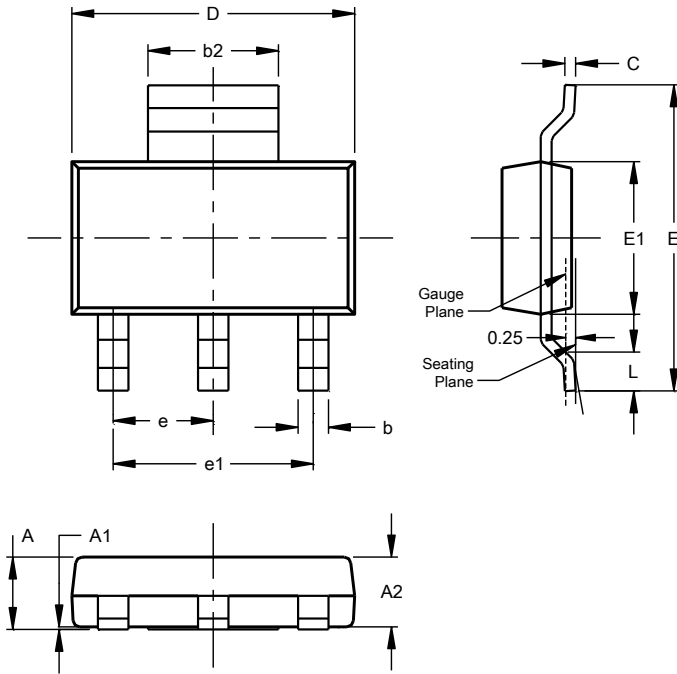

SOT223 (Type DN)			
Dim	Min	Max	Typ
A	--	1.70	--
A1	0.01	0.15	--
A2	1.50	1.68	1.60
b	0.60	0.80	0.70
b2	2.90	3.10	--
c	0.20	0.32	--
D	6.30	6.70	--
E	6.70	7.30	--
E1	3.30	3.70	--
e	--	--	2.30
e1	--	--	4.60
L	0.85	--	--
<b>All Dimensions in mm</b>			

**Suggested Pad Layout**

Please see <http://www.diodes.com/package-outlines.html> for the latest version.

**SOT223 (Type DN)**

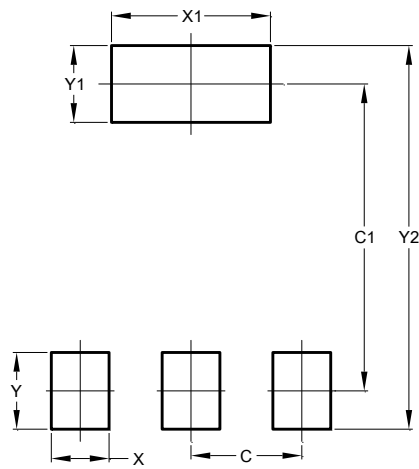

Dimensions	Value (in mm)
C	2.30
C1	6.40
X	1.20
X1	3.30
Y	1.60
Y1	1.60
Y2	8.00



**IMPORTANT NOTICE**

DIODES INCORPORATED MAKES NO WARRANTY OF ANY KIND, EXPRESS OR IMPLIED, WITH REGARDS TO THIS DOCUMENT, INCLUDING, BUT NOT LIMITED TO, THE IMPLIED WARRANTIES OF MERCHANTABILITY AND FITNESS FOR A PARTICULAR PURPOSE (AND THEIR EQUIVALENTS UNDER THE LAWS OF ANY JURISDICTION).

Diodes Incorporated and its subsidiaries reserve the right to make modifications, enhancements, improvements, corrections or other changes without further notice to this document and any product described herein. Diodes Incorporated does not assume any liability arising out of the application or use of this document or any product described herein; neither does Diodes Incorporated convey any license under its patent or trademark rights, nor the rights of others. Any Customer or user of this document or products described herein in such applications shall assume all risks of such use and will agree to hold Diodes Incorporated and all the companies whose products are represented on Diodes Incorporated website, harmless against all damages.

Diodes Incorporated does not warrant or accept any liability whatsoever in respect of any products purchased through unauthorized sales channel. Should Customers purchase or use Diodes Incorporated products for any unintended or unauthorized application, Customers shall indemnify and hold Diodes Incorporated and its representatives harmless against all claims, damages, expenses, and attorney fees arising out of, directly or indirectly, any claim of personal injury or death associated with such unintended or unauthorized application.

Products described herein may be covered by one or more United States, international or foreign patents pending. Product names and markings noted herein may also be covered by one or more United States, international or foreign trademarks.

This document is written in English but may be translated into multiple languages for reference. Only the English version of this document is the final and determinative format released by Diodes Incorporated.

**LIFE SUPPORT**

Diodes Incorporated products are specifically not authorized for use as critical components in life support devices or systems without the express written approval of the Chief Executive Officer of Diodes Incorporated. As used herein:

A. Life support devices or systems are devices or systems which:

1. are intended to implant into the body, or
2. support or sustain life and whose failure to perform when properly used in accordance with instructions for use provided in the labeling can be reasonably expected to result in significant injury to the user.

B. A critical component is any component in a life support device or system whose failure to perform can be reasonably expected to cause the failure of the life support device or to affect its safety or effectiveness.

Customers represent that they have all necessary expertise in the safety and regulatory ramifications of their life support devices or systems, and acknowledge and agree that they are solely responsible for all legal, regulatory and safety-related requirements concerning their products and any use of Diodes Incorporated products in such safety-critical, life support devices or systems, notwithstanding any devices- or systems-related information or support that may be provided by Diodes Incorporated. Further, Customers must fully indemnify Diodes Incorporated and its representatives against any damages arising out of the use of Diodes Incorporated products in such safety-critical, life support devices or systems.

Copyright © 2018, Diodes Incorporated

[www.diodes.com](http://www.diodes.com)

单击下面可查看定价，库存，交付和生命周期等信息

[>>Diodes Incorporated\(达达科技\(美台\)\)](#)