

Description

The AL3158 is a low noise, constant frequency charge pump DC/DC converter that uses a Dual mode load switch (1x), and (2x) conversion for white LED applications. The AL3158 is capable of driving three groups of three LED channels at 20mA from a 2.7V to 5.5V input. The current sinks may be operated using three simple PWM dimming inputs individually or in parallel for driving higher-current LEDs. Low external part counts (one 1µF flying capacitor and two 2.2µF capacitors at V_{IN} and V_{OUT}) make this part ideally suited for small, battery-powered applications.

AL3158 PWM dimming inputs are used to enable, disable device and dimming LED current with a fixed default current settings at 20mA or other factory programming options available.

Each output of the AL3158 is equipped with built-in protection for V_{OUT} short circuit and auto-disable for LED short conditions. Built-in soft-start circuitry prevents excessive inrush current during start-up and mode switching. A low-current shutdown feature disconnects the load from V_{IN} to reduce quiescent current less than 1µA.

The AL3158 is available in a lead-free, space-saving, thermally enhanced 20-pin QFN package.

Features

- V_{IN} Range: 2.7V to 5.5V
- Up to 93% Max Power Efficiency
- 1% Current Matching Accuracy Between Channels
- Three simple PWM dimming for RGB or WLED
- Low transition threshold voltage typical 150 mV
- Dual-Mode 1x and 2x Charge Pump
- Drives up to 3 + 3 + 3 Channels of LEDs
- 1.2 MHz Constant Switching Frequency
- V_{OUT} short circuit and Thermal Protections
- Soft Start for reducing inrush current
- Under Voltage Lockout Protection
- $I_Q < 1\mu A$ in Shutdown
- Thermally-Enhanced QFN3030-20 Package: Available in "Green" Molding Compound (No Br, Sb)
- Lead Free Finish/ RoHS Compliant (Note 1)

Notes: 1. EU Directive 2002/95/EC (RoHS). All applicable RoHS exemptions applied. Please visit our website at http://www.diodes.com/products/lead_free.html

Pin Assignments

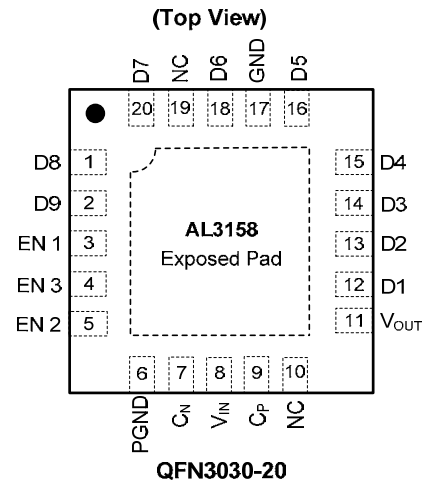

Applications

- Mobile Phone White LED Backlighting and Indicators
- PDA White LED Backlighting
- Battery-operated Phone Main and Sub Screen White LED Backlighting

Typical Application Circuit

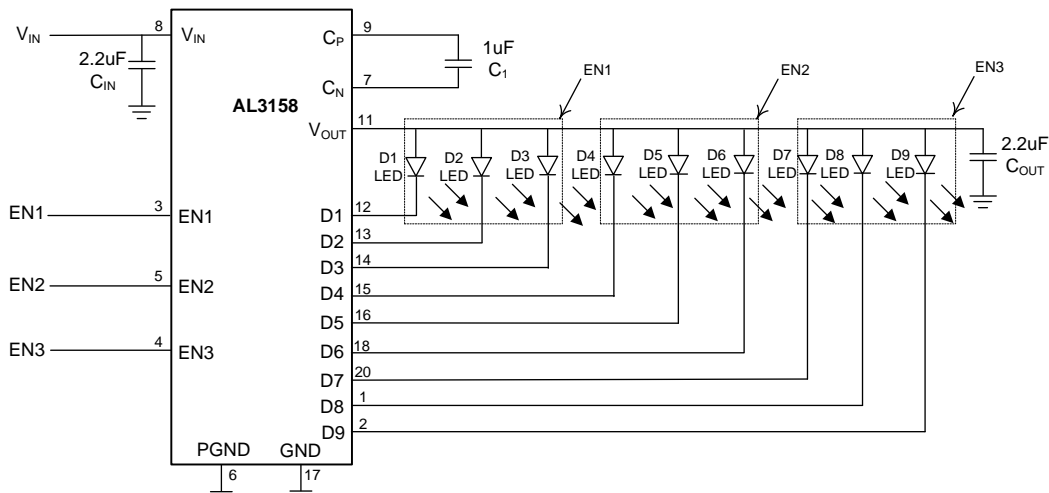

Pin Descriptions

Pin Name	Pin Number	Description
D8	1	Current sink input #8. Connected to V _{OUT} when un-used.
D9	2	Current sink input #9. Connected to V _{OUT} when un-used.
EN1	3	Enable Pin 1
EN3	4	Enable Pin 3
EN2	5	Enable Pin 2
PGND	6	Charge Pump Switch Ground
CN	7	Negative Terminal of Flying Capacitor
VIN	8	Input Power Supply. Requires 2.2μF capacitor between this pin and ground.
CP	9	Positive Terminal of Flying Capacitor
NC	10,19	No-Connect
V _{OUT}	11	Charge pump output to drive load circuit. Requires 2.2μF capacitor between this pin and ground.
D1	12	Current sink input #1. Connected to V _{OUT} when un-used.
D2	13	Current sink input #2. Connected to V _{OUT} when un-used.
D3	14	Current sink input #3. Connected to V _{OUT} when un-used.
D4	15	Current sink input #4. Connected to V _{OUT} when un-used.
D5	16	Current sink input #5. Connected to V _{OUT} when un-used.
D6	18	Current sink input #6. Connected to V _{OUT} when un-used.
GND	17	Ground
D7	20	Current sink input #7. Connected to V _{OUT} when un-used.
GND	EP PAD	Exposed Pad (bottom). Connected to GND directly underneath the package.

Functional Block Diagram

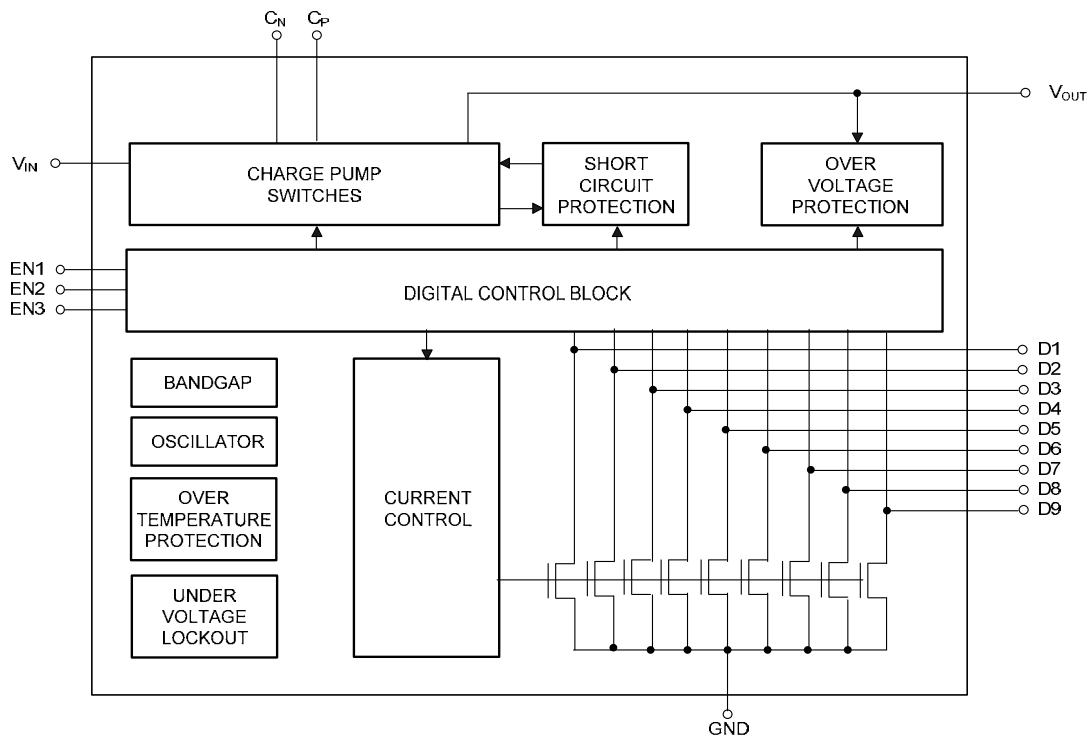

Absolute Maximum Ratings (Note 2)

Symbol	Description	Rating	Unit
ESD HBM	Human Body Model ESD Protection	2	KV
ESD MM	Machine Model ESD Protection	200	V
V_{IN}	Input Voltage	-0.3 to 6	V
$V_{EN1,2,3}$	EN1, EN2, EN3 to GND Voltage	-0.3 to $V_{IN} + 0.3$	V
I_{OUT}	Maximum DC Output Current	270	mA
T_J	Operating Junction Temperature Range	150	°C
T_{LEAD}	Maximum Soldering Temperature (at leads, 10 sec)	300	°C

Notes: 2. Exceeding Absolute Maximum Ratings will cause permanent damage to the device.

Recommended Operating Conditions

Symbol	Parameter	Min	Max	Unit
V_{IN}	Input Voltage	2.7	5.5	V
T_A	Operating Ambient Temperature	-40	85	°C

Electrical Characteristics ($T_A = 25^\circ\text{C}$, $V_{in} = 3.6\text{V}$, $C_{IN} = C_{OUT} = 2.2\mu\text{F}$, $C_1 = 1\mu\text{F}$ Unless otherwise noted)

Symbol	Parameter	Test Conditions	Min	Typ.	Max	Unit
I_Q	Quiescent Current	1x Mode, $3.0 \leq V_{IN} \leq 5.5$, Active, No Load Current		0.3	0.6	mA
		2x Mode, $3.0 \leq V_{IN} \leq 5.5$, Active, No Load Current		2	5	
I_{SHDN}	Shutdown Current	EN1, EN2, EN3 = 0			1	μA
I_{DX}	I_{SINK} Current Accuracy (Note 3)		19	20	21	mA
$I_{D-Match}$	Current Matching Between Any Two Current Sink Inputs (Note 4)	$V_F: D1:D9 = 3.6\text{V}$		1	2	%
R_{out}	Open Loop V_{OUT} Resistance	1x mode		0.5		Ω
		2 x mode		4.5		
V_{TH}	1x to 2x Transition Threshold at Any I_{SINK} Pin	$I_{DX} = 20\text{mA}$		150		mV
V_{HS}	Mode Transition Hysteresis			250		mV
T_{SS}	Soft-Start Time			100		μs
F_{sw}	Switching Frequency			1.2		MHz
$V_{EN1,2,3(L)}$	EN1,2,3 Threshold Low	$V_{IN} = 2.7\text{V}$			0.4	V
$V_{EN1,2,3(H)}$	EN1,2,3 Threshold High	$V_{IN} = 5.5\text{V}$	1.4			V
$T_{EN1,2,3}$	EN1,2,3 Off Timeout				20	ms
UVLO	V_{IN} Under-Voltage Lockout		1.8	2	2.2	V
$I_{EN1,2,3}$	EN1,2,3 Input Leakage		-1		1	μA
T_{SHDN}	Thermal shutdown Protection			160		°C
T_{HYS}	Thermal shutdown hysteresis			10		°C
θ_{JA}	Thermal Resistance Junction-to-Ambient	QFN3030-20 (Note 5)		52		°C/W

Notes: 3. Determined by the average current levels of all active channels.

4. Determined by the maximum sink current (MAX), the minimum sink current (MIN), and the average sink current (AVG). Two matching numbers are calculated as $(MAX-AVG)/AVG$ and $(AVG-MIN)/AVG$. The largest number of the two (worst case) is considered as the matching data.

5. Device mounted on FR-4 substrate, 2"×2", 2oz copper, double-sided PC board, with minimum recommended pad on top layer and 4 vias to bottom layer.

Typical Performance Characteristics

Turn-On to 1x Mode

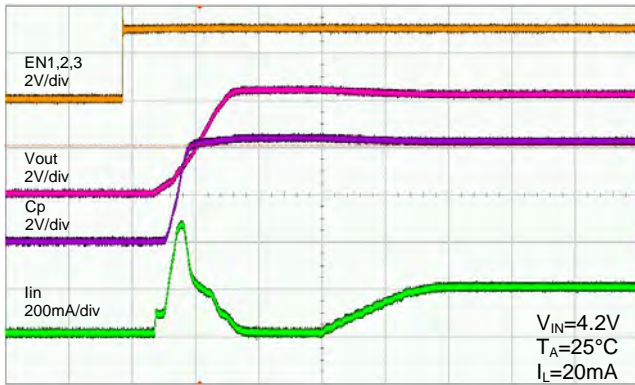

50us/div

Turn-On to 2x Mode

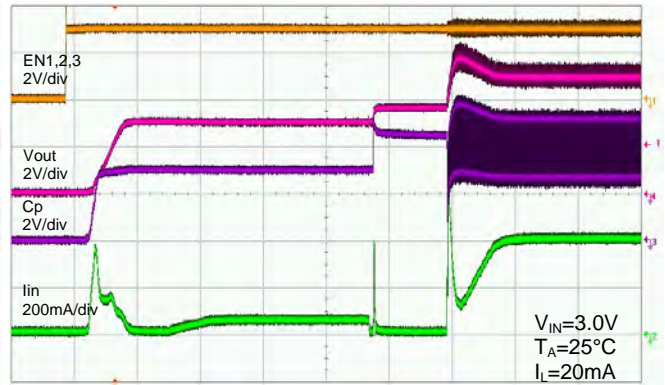

100us/div

Turn-Off from 1x Mode

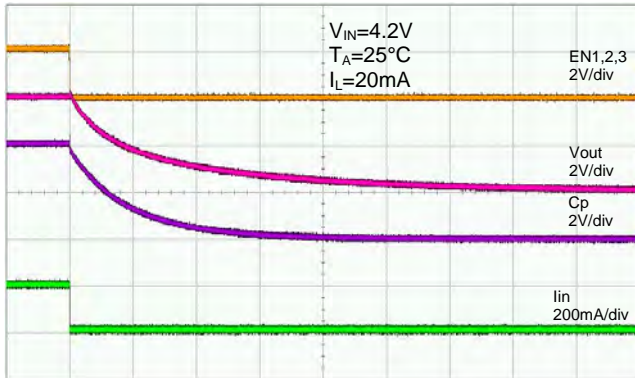

200ms/div

Turn-Off from 2x Mode

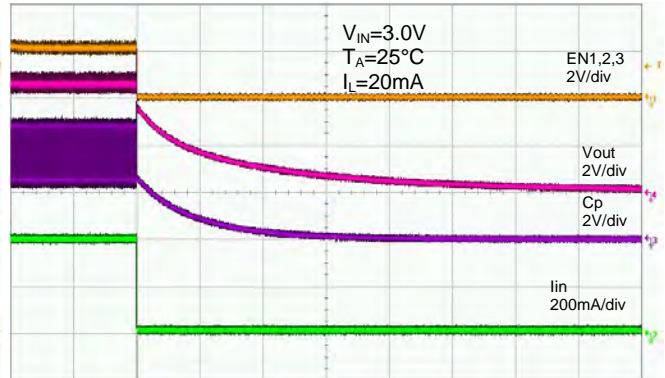

200ms/div

Load Characteristics in 2x Mode

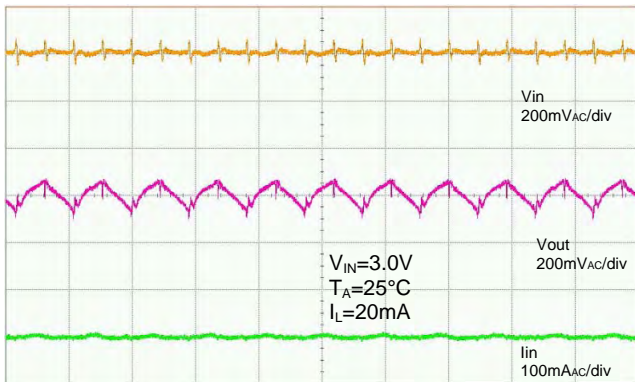

1us/div

PWM Dimming Control (Duty Cycle=50%)

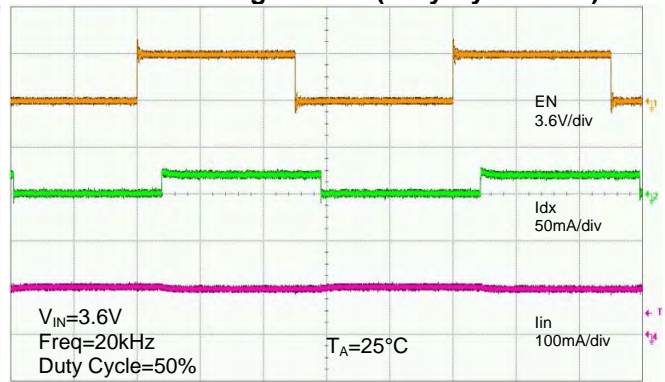

10us/div

NEW PRODUCT

Typical Performance Characteristics (Continued)

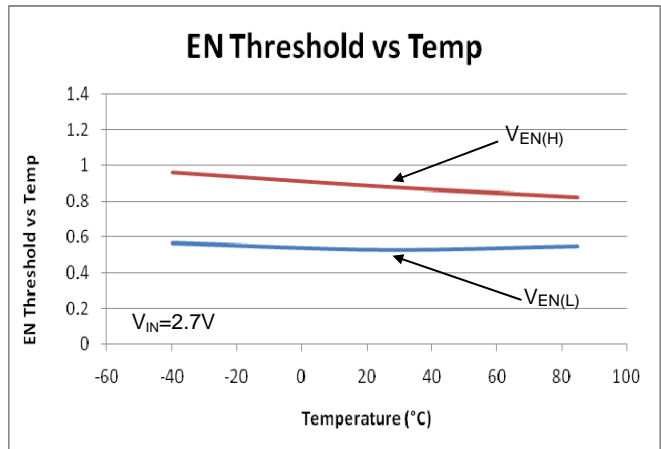
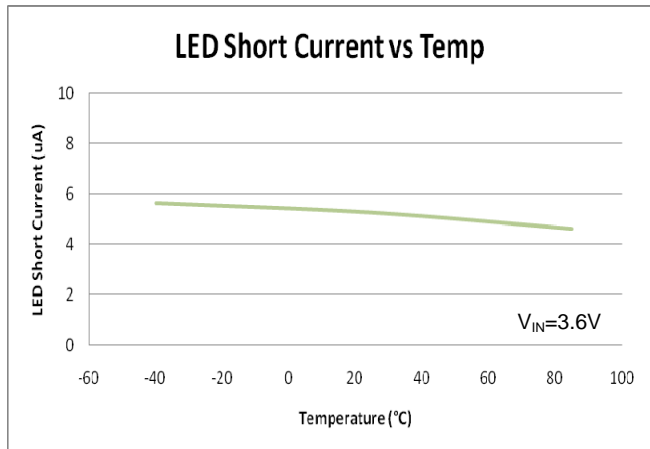
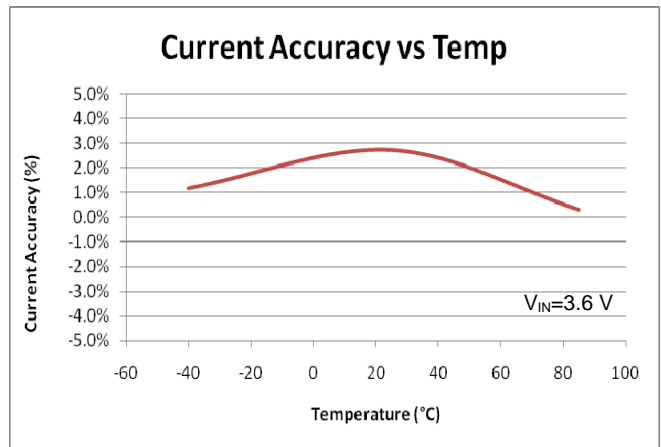
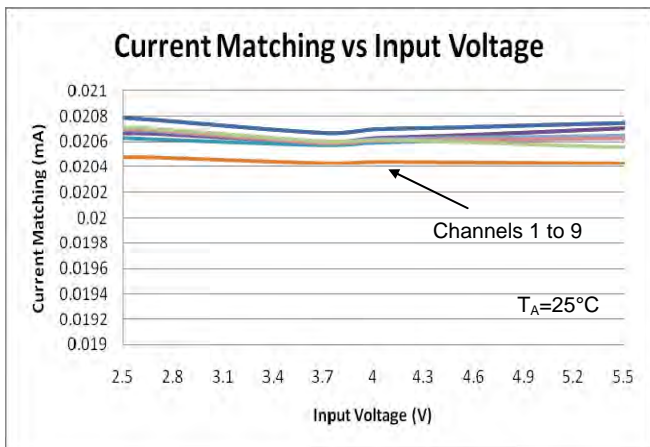
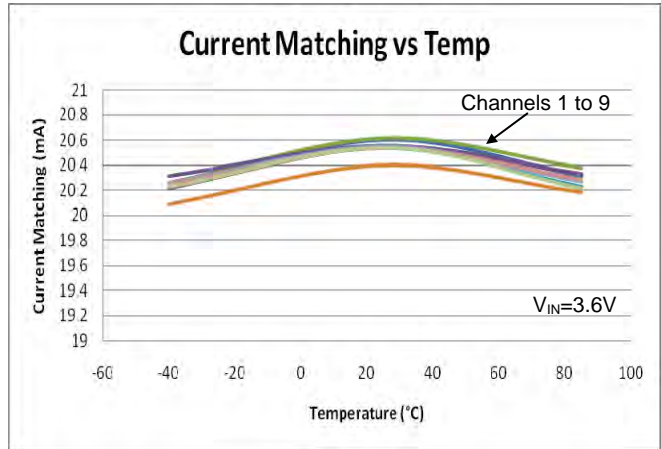
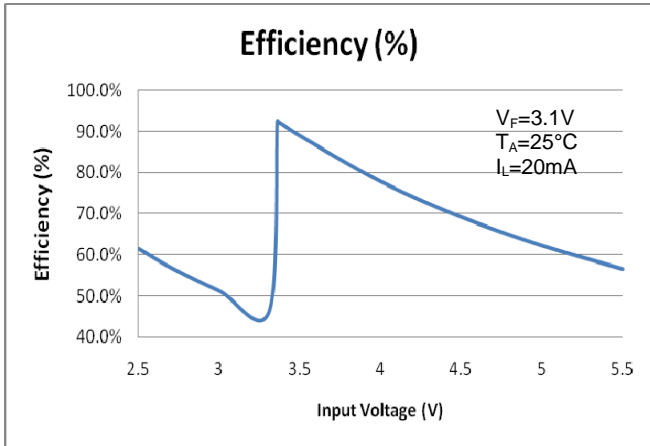

Functional Description

The AL3158 is a dual-mode high efficiency charge pump (1x and 2x) device, driving three groups of three LED channels at 30mA maximum each, intended for white LED backlight applications. An internal comparator circuit compares the voltage at each constant current sink input against a reference voltage. To ensure maximum power efficiency, the most appropriate switching mode (1x and 2x) is automatically selected.

The AL3158 requires only three external components: one 1 μ F ceramic flying capacitor (C₁) for the charge pump, one 2.2 μ F ceramic input capacitor (C_{IN}), and one 2.2 μ F ceramic charge pump output capacitor (C_{OUT}).

The each output channel of the AL3158 can drive three groups of three individual LED channels with a maximum current of fixed manufacture setting (20mA or 30mA) per channel. These can be paralleled to give a total output current of 270mA.

EN<3:1>	LED ON/OFF CONTROL
XX0	LED1~LED3 OFF
XX1	LED1~LED3 ON
X0X	LED4~LED6 OFF
X1x	LED4~LED6 ON
0XX	LED7~LED9 OFF
1xX	LED7~LED9 ON

Disabled Current Sinks

Unused current channels must be disabled by connecting the sinks to VOUT with only a small sense current flowing through the disabled channel.

Soft-Start

Soft-start is incorporated to prevent excessive inrush current during power-up, mode switching, and transitioning out of stand-by mode.

Short-Circuit Protection

Short-circuit protection function is incorporated to prevent excessive load current when either flying cap terminals or output pin electrically tied to a very lower voltage or ground.

Over-Voltage Protection

Over-Voltage Protection function is incorporated to limit the output voltage under a safe value to avoid on-chip device breakdown.

Under-Voltage Lockout

Under-Voltage lockout feature disables the device when the input voltage drops below UVLO threshold.

Thermal Auto Shutdown

When the die temperature exceeds the thermal limit, the device will be disabled and enter stand-by mode. The operation resumes whenever the die cools off sufficiently.

PWM Dimming Control

The AL3158 provides simple PWM dimming control through ENx pins, and the current is adjusted by the duty cycle of the signal applied on ENx pin. The recommended PWM frequency is from 200Hz to 50KHz depending on applications.

Ordering Information

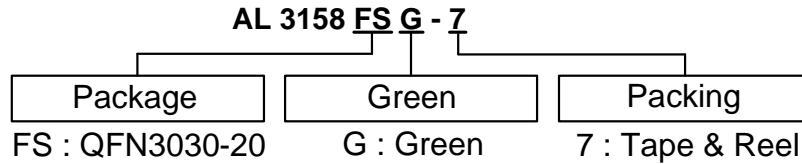

Device	Package Code	Packaging (Note 7 and 8)	7" Tape and Reel	
			Quantity	Part Number Suffix
AL3158FSG-7	FS	QFN3030-20	3000/Tape & Reel	-7



Notes: 7. Pad layout as shown on Diodes Inc. suggested pad layout document AP02001, which can be found on our website at <http://www.diodes.com/datasheets/ap02001.pdf>
 8. EU Directive 2002/95/EC (RoHS). All applicable RoHS exemptions applied. Please visit our website at http://www.diodes.com/products/lead_free.html

Marking Information

(1) QFN3030-20

(Top View)

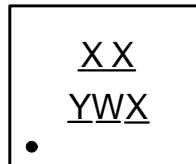

XX : B8 : AL3158
Y : Year : 0~9
W : Week : A~Z : 1~26 week;
 a~z : 27~52 week; z represents
 52 and 53 week
X : A~Z : Green

Part Number	Package	Identification Code
AL3158FSG	QFN3030-20	B8

Package Outline Dimensions (All Dimensions in mm)

Package type: QFN3030-20

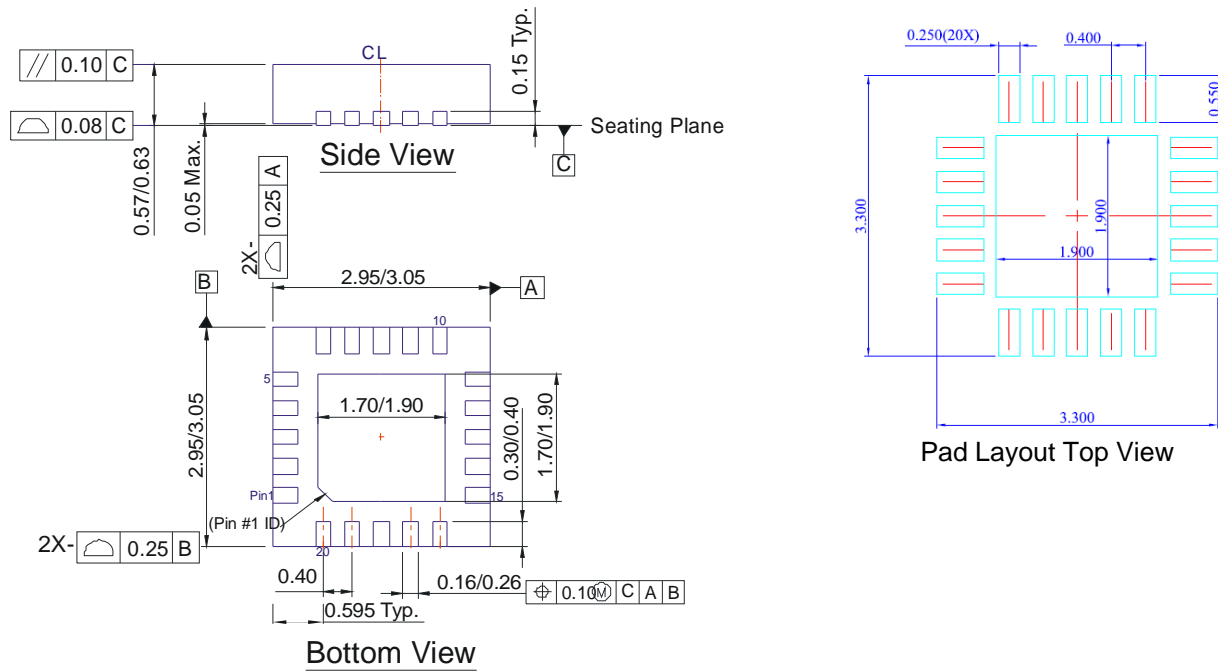

NEW PRODUCT

Taping Orientation (Note 9)

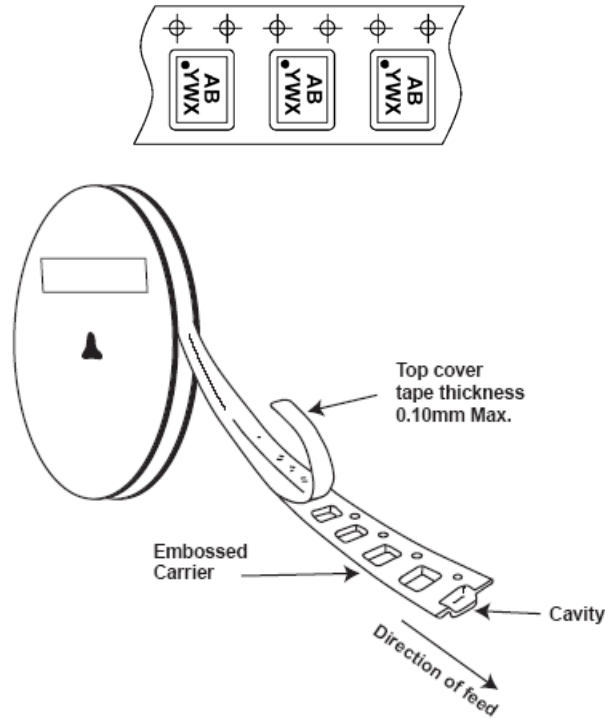

Notes: 9. The taping orientation of the other package type can be found on our website at <http://www.diodes.com/datasheets/ap02007.pdf>

**HIGH EFFICIENCY 1x/2x CHARGE PUMP
FOR WHITE LED APPLICATIONS****IMPORTANT NOTICE**

DIODES INCORPORATED MAKES NO WARRANTY OF ANY KIND, EXPRESS OR IMPLIED, WITH REGARDS TO THIS DOCUMENT, INCLUDING, BUT NOT LIMITED TO, THE IMPLIED WARRANTIES OF MERCHANTABILITY AND FITNESS FOR A PARTICULAR PURPOSE (AND THEIR EQUIVALENTS UNDER THE LAWS OF ANY JURISDICTION).

Diodes Incorporated and its subsidiaries reserve the right to make modifications, enhancements, improvements, corrections or other changes without further notice to this document and any product described herein. Diodes Incorporated does not assume any liability arising out of the application or use of this document or any product described herein; neither does Diodes Incorporated convey any license under its patent or trademark rights, nor the rights of others. Any Customer or user of this document or products described herein in such applications shall assume all risks of such use and will agree to hold Diodes Incorporated and all the companies whose products are represented on Diodes Incorporated website, harmless against all damages.

Diodes Incorporated does not warrant or accept any liability whatsoever in respect of any products purchased through unauthorized sales channel.

Should Customers purchase or use Diodes Incorporated products for any unintended or unauthorized application, Customers shall indemnify and hold Diodes Incorporated and its representatives harmless against all claims, damages, expenses, and attorney fees arising out of, directly or indirectly, any claim of personal injury or death associated with such unintended or unauthorized application.

Products described herein may be covered by one or more United States, international or foreign patents pending. Product names and markings noted herein may also be covered by one or more United States, international or foreign trademarks.

LIFE SUPPORT

Diodes Incorporated products are specifically not authorized for use as critical components in life support devices or systems without the express written approval of the Chief Executive Officer of Diodes Incorporated. As used herein:

A. Life support devices or systems are devices or systems which:

1. are intended to implant into the body, or
2. support or sustain life and whose failure to perform when properly used in accordance with instructions for use provided in the labeling can be reasonably expected to result in significant injury to the user.

B. A critical component is any component in a life support device or system whose failure to perform can be reasonably expected to cause the failure of the life support device or to affect its safety or effectiveness.

Customers represent that they have all necessary expertise in the safety and regulatory ramifications of their life support devices or systems, and acknowledge and agree that they are solely responsible for all legal, regulatory and safety-related requirements concerning their products and any use of Diodes Incorporated products in such safety-critical, life support devices or systems, notwithstanding any devices- or systems-related information or support that may be provided by Diodes Incorporated. Further, Customers must fully indemnify Diodes Incorporated and its representatives against any damages arising out of the use of Diodes Incorporated products in such safety-critical, life support devices or systems.

Copyright © 2011, Diodes Incorporated

www.diodes.com

单击下面可查看定价，库存，交付和生命周期等信息

[>>Diodes Incorporated\(达达科技\(美台\)\)](#)