

DUAL 20V PNP LOW SATURATION SWITCHING TRANSISTOR

Features and Benefits

- $BV_{CEO} > -20V$;
- $I_C = -3.5A$ Continuous Collector Current
- $R_{SAT} = 64\ m\Omega$ for Low Equivalent On Resistance
- Low Saturation Voltage ($-220mV$ @ $-1A$)
- hFE characterized up to $-6A$ for high current gain holds up
- Dual NPN saving footprint and component count
- Low profile 0.8mm high package for thin applications
- $R_{\theta JA}$ efficient, 40% lower than SOT26
- $6mm^2$ footprint, 50% smaller than TSOP6 and SOT26
- **Lead-Free, RoHS Compliant (Note 1)**
- **Halogen and Antimony Free. "Green" Device (Note 2)**
- **Qualified to AEC-Q101 Standards for High Reliability**

Mechanical Data

- Case: DFN3020B-8
- Case material: Molded Plastic. "Green" Molding Compound.
- UL Flammability Rating 94V-0
- Terminals: Pre-Plated NiPdAu leadframe.
- Nominal package height: 0.8mm
- Moisture Sensitivity: Level 1 per J-STD-020
- Solderable per MIL-STD-202, Method 208
- Weight: 0.013 grams (approximate)

Applications

- Battery charging circuits
- Load disconnect switches
- DC-DC converters
- Motor drive
- LED backlighting circuits
- Portable applications

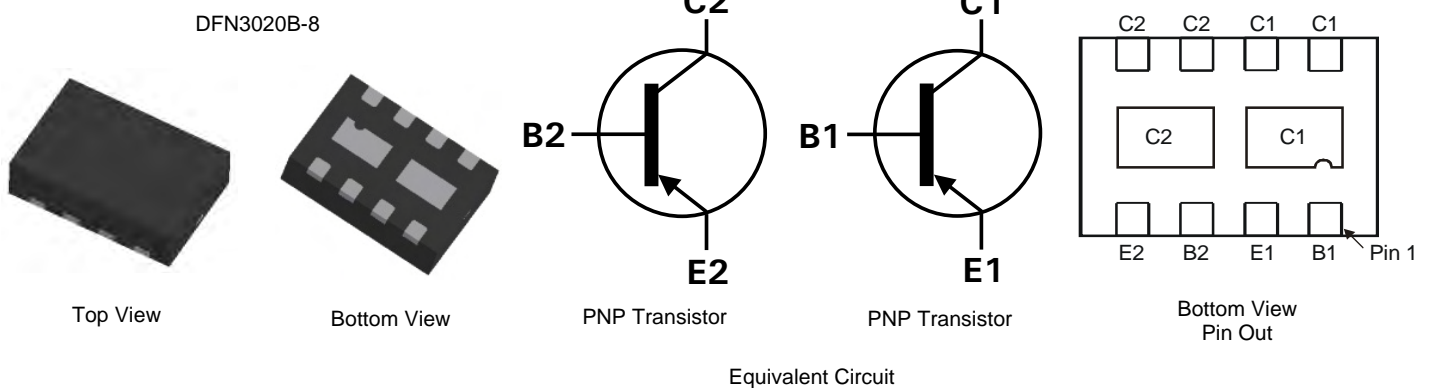

Ordering Information (Note 3)

| Product | Marking | Reel size (inches) | Tape width (mm) | Quantity per reel |
|-------------|---------|--------------------|-----------------|-------------------|
| ZXTD718MCTA | D22 | 7 | 8 | 3,000 |

- Notes:
1. No purposefully added lead.
 2. Diodes Inc's "Green" Policy can be found on our website at <http://www.diodes.com>
 3. For Packaging Details, go to our website at <http://www.diodes.com>.

Marking Information



D22 = Product type Marking Code
Top view, dot denotes Pin 1

Maximum Ratings @ $T_A = 25^\circ\text{C}$ unless otherwise specified

| Parameter | Symbol | Limit | Unit |
|----------------------------------------------|-----------|-------|------|
| Collector-Base Voltage | V_{CBO} | -25 | V |
| Collector-Emitter Voltage | V_{CEO} | -20 | |
| Emitter-Base Voltage | V_{EBO} | -7 | |
| Peak Pulse Current | I_{CM} | -6 | A |
| Continuous Collector Current (Notes 4 and 7) | I_C | -3.5 | |
| Base Current | I_B | -1 | |

Thermal Characteristics @ $T_A = 25^\circ\text{C}$ unless otherwise specified

| Characteristic | Symbol | Value | Unit |
|---------------------------------------------|-----------------|-------------|------------|
| Power Dissipation Linear Derating Factor | P_D | 1.5 | W mW/°C |
| | | 12 | |
| | | 2.45 | |
| | | 19.6 | |
| | | 1.13 | |
| Thermal Resistance, Junction to Ambient | $R_{\theta JA}$ | 8 | °C/W |
| | | 1.7 | |
| | | 13.6 | |
| | | 83.3 | |
| Thermal Resistance, Junction to Ambient | $R_{\theta JA}$ | 51.0 | °C/W |
| | | 111 | |
| | | 73.5 | |
| | | 17.1 | |
| Thermal Resistance, Junction to Lead | $R_{\theta JL}$ | 17.1 | °C/W |
| Operating and Storage Temperature Range | T_J, T_{STG} | -55 to +150 | °C |

- Notes:
4. For a dual device surface mounted on 28mm x 28mm (8cm²) FR4 PCB with high coverage of single sided 2 oz copper, in still air conditions; the device is measured when operating in a steady-state condition. The heatsink is split in half with the exposed collector pads connected to each half.
 5. Same as note (4), except the device is measured at $t < 5$ sec.
 6. Same as note (4), except the device is surface mounted on 31mm x 31mm (10cm²) FR4 PCB with high coverage of single sided 1oz copper.
 7. For a dual device with one active die.
 8. For dual device with 2 active die running at equal power.
 9. Thermal resistance from junction to solder-point (at the end of the collector lead).

Thermal Characteristics

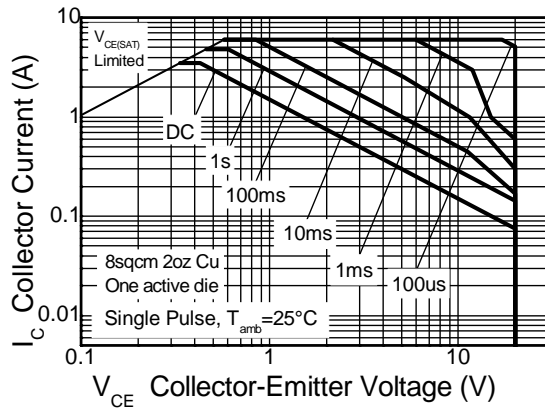

Safe Operating Area

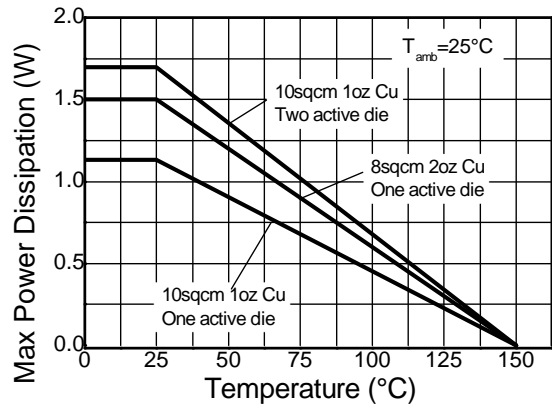

Derating Curve

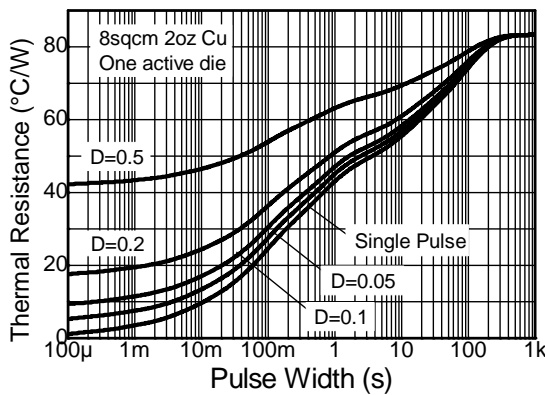

Transient Thermal Impedance

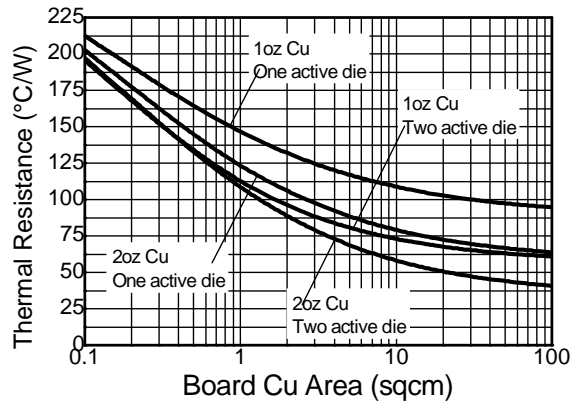

Thermal Resistance v Board Area

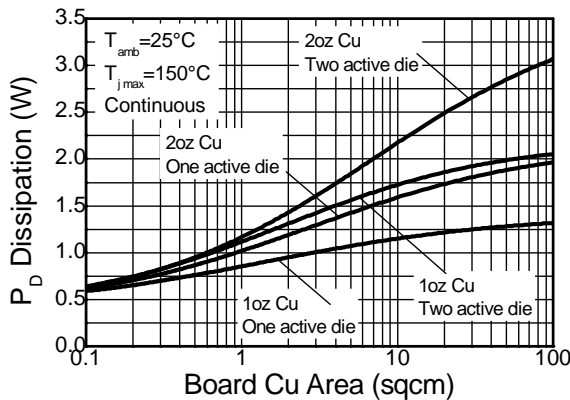

Power Dissipation v Board Area

Electrical Characteristics @ $T_A = 25^\circ\text{C}$ unless otherwise specified

| Characteristic | Symbol | Min | Typ | Max | Unit | Test Condition |
|-------------------------------------------------|---------------|-----|-------|-------|------|---------------------------------------------------------------|
| Collector-Base Breakdown Voltage | BV_{CBO} | -25 | -35 | - | V | $I_C = -100\mu\text{A}$ |
| Collector-Emitter Breakdown Voltage (Note 10) | BV_{CEO} | -20 | -25 | - | V | $I_C = 10\text{mA}$ |
| Emitter-Base Breakdown Voltage | BV_{EBO} | -7 | 8.5 | - | V | $I_E = -100\mu\text{A}$ |
| Collector Cutoff Current | I_{CBO} | - | - | -100 | nA | $V_{CB} = -20\text{V}$ |
| Emitter Cutoff Current | I_{EBO} | - | - | -100 | nA | $V_{EB} = -6\text{V}$ |
| Collector Emitter Cutoff Current | I_{CES} | - | - | -100 | nA | $V_{CES} = -16\text{V}$ |
| Static Forward Current Transfer Ratio (Note 10) | h_{FE} | 300 | 475 | - | - | $I_C = -10\text{mA}, V_{CE} = -2\text{V}$ |
| | | 300 | 450 | - | | $I_C = -100\text{mA}, V_{CE} = -2\text{V}$ |
| | | 150 | 230 | - | | $I_C = -2\text{A}, V_{CE} = -2\text{V}$ |
| | | 15 | 30 | - | | $I_C = -6\text{A}, V_{CE} = -2\text{V}$ |
| Collector-Emitter Saturation Voltage (Note 10) | $V_{CE(sat)}$ | - | -19 | -30 | mV | $I_C = -0.1\text{A}, I_B = -10\text{mA}$ |
| | | - | -170 | -220 | | $I_C = -1\text{A}, I_B = -20\text{mA}$ |
| | | - | -190 | -250 | | $I_C = -1.5\text{A}, I_B = -50\text{mA}$ |
| | | - | -240 | -350 | | $I_C = -2.5\text{A}, I_B = -150\text{mA}$ |
| | | - | -225 | -300 | | $I_C = -3.5\text{A}, I_B = -350\text{mA}$ |
| Base-Emitter Turn-On Voltage (Note 10) | $V_{BE(on)}$ | - | -0.87 | -0.95 | V | $I_C = -3.5\text{A}, V_{CE} = -2\text{V}$ |
| Base-Emitter Saturation Voltage (Note 10) | $V_{BE(sat)}$ | - | -1.01 | -1.12 | V | $I_C = -3.5\text{A}, I_B = -350\text{mA}$ |
| Output Capacitance | C_{obo} | - | 21 | 30 | pF | $V_{CB} = 10\text{V}, f = 1\text{MHz}$ |
| Transition Frequency | f_T | 150 | 180 | - | MHz | $V_{CE} = -10\text{V}, I_C = -50\text{mA}, f = 100\text{MHz}$ |
| Turn-On Time | t_{on} | - | 40 | - | ns | $V_{CC} = -10\text{V}, I_C = 1\text{A}$ |
| Turn-Off Time | t_{off} | - | 670 | - | ns | $I_{B1} = I_{B2} = 20\text{mA}$ |

Notes: 10. Measured under pulsed conditions. Pulse width $\leq 300\mu\text{s}$. Duty cycle $\leq 2\%$

Typical Electrical Characteristics

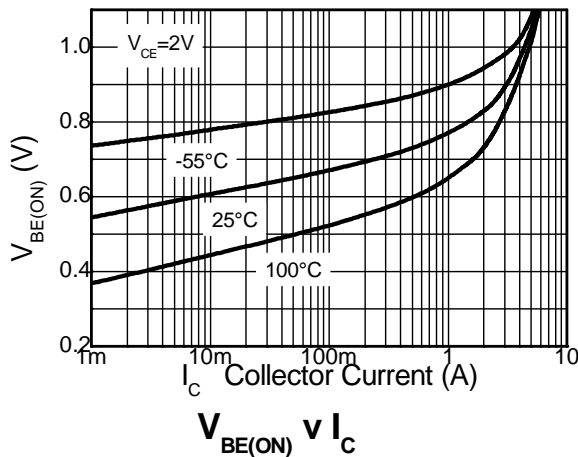
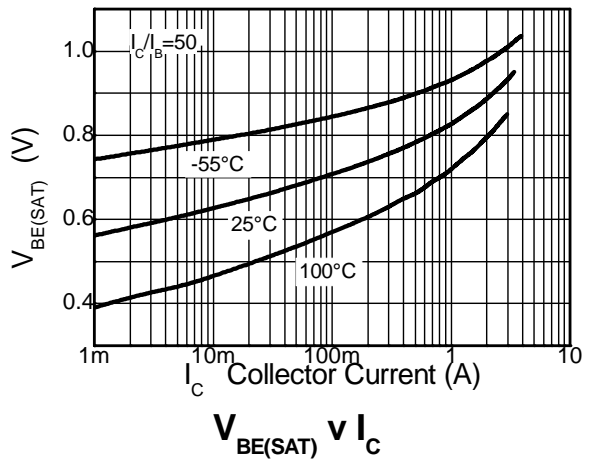
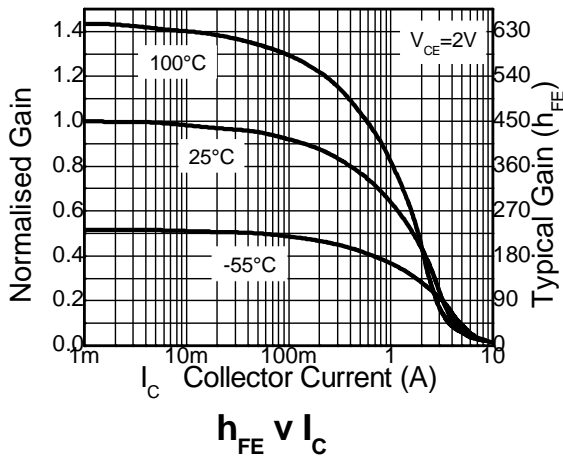
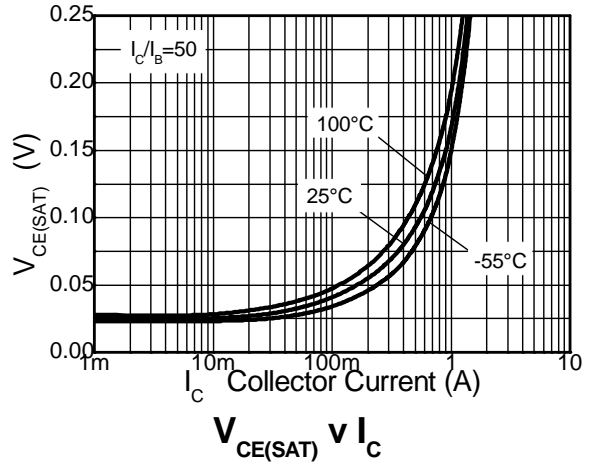
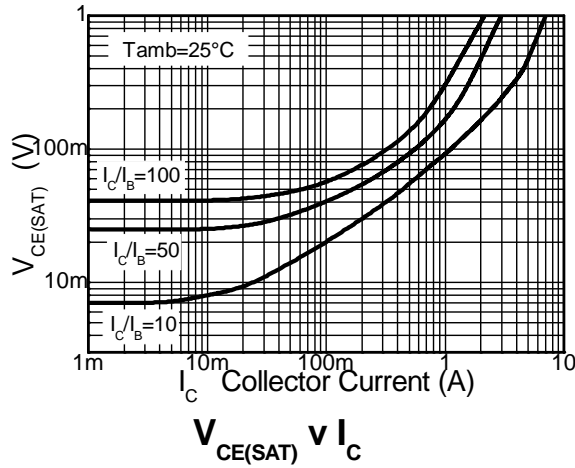

Package Outline Dimensions

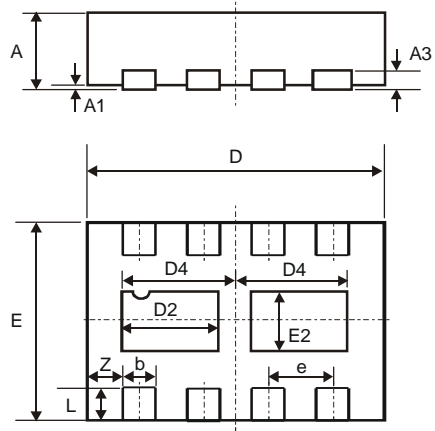

| DFN3020B-8 | | | |
|----------------------|------|-------|-------|
| Dim | Min | Max | Typ |
| A | 0.77 | 0.83 | 0.80 |
| A1 | 0 | 0.05 | 0.02 |
| A3 | - | - | 0.15 |
| b | 0.25 | 0.35 | 0.30 |
| D | 2.95 | 3.075 | 3.00 |
| D2 | 0.82 | 1.02 | 0.92 |
| D4 | 1.01 | 1.21 | 1.11 |
| e | - | - | 0.65 |
| E | 1.95 | 2.075 | 2.00 |
| E2 | 0.43 | 0.63 | 0.53 |
| L | 0.25 | 0.35 | 0.30 |
| Z | - | - | 0.375 |
| All Dimensions in mm | | | |

Suggested Pad Layout

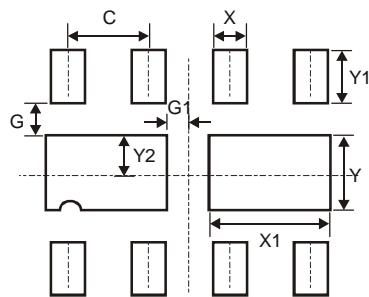

| Dimensions | Value (in mm) |
|------------|---------------|
| C | 0.650 |
| G | 0.285 |
| G1 | 0.090 |
| X | 0.400 |
| X1 | 1.120 |
| Y | 0.730 |
| Y1 | 0.500 |
| Y2 | 0.365 |

IMPORTANT NOTICE

DIODES INCORPORATED MAKES NO WARRANTY OF ANY KIND, EXPRESS OR IMPLIED, WITH REGARDS TO THIS DOCUMENT, INCLUDING, BUT NOT LIMITED TO, THE IMPLIED WARRANTIES OF MERCHANTABILITY AND FITNESS FOR A PARTICULAR PURPOSE (AND THEIR EQUIVALENTS UNDER THE LAWS OF ANY JURISDICTION).

Diodes Incorporated and its subsidiaries reserve the right to make modifications, enhancements, improvements, corrections or other changes without further notice to this document and any product described herein. Diodes Incorporated does not assume any liability arising out of the application or use of this document or any product described herein; neither does Diodes Incorporated convey any license under its patent or trademark rights, nor the rights of others. Any Customer or user of this document or products described herein in such applications shall assume all risks of such use and will agree to hold Diodes Incorporated and all the companies whose products are represented on Diodes Incorporated website, harmless against all damages.

Diodes Incorporated does not warrant or accept any liability whatsoever in respect of any products purchased through unauthorized sales channel. Should Customers purchase or use Diodes Incorporated products for any unintended or unauthorized application, Customers shall indemnify and hold Diodes Incorporated and its representatives harmless against all claims, damages, expenses, and attorney fees arising out of, directly or indirectly, any claim of personal injury or death associated with such unintended or unauthorized application.

Products described herein may be covered by one or more United States, international or foreign patents pending. Product names and markings noted herein may also be covered by one or more United States, international or foreign trademarks.

LIFE SUPPORT

Diodes Incorporated products are specifically not authorized for use as critical components in life support devices or systems without the express written approval of the Chief Executive Officer of Diodes Incorporated. As used herein:

A. Life support devices or systems are devices or systems which:

1. are intended to implant into the body, or
2. support or sustain life and whose failure to perform when properly used in accordance with instructions for use provided in the labeling can be reasonably expected to result in significant injury to the user.

B. A critical component is any component in a life support device or system whose failure to perform can be reasonably expected to cause the failure of the life support device or to affect its safety or effectiveness.

Customers represent that they have all necessary expertise in the safety and regulatory ramifications of their life support devices or systems, and acknowledge and agree that they are solely responsible for all legal, regulatory and safety-related requirements concerning their products and any use of Diodes Incorporated products in such safety-critical, life support devices or systems, notwithstanding any devices- or systems-related information or support that may be provided by Diodes Incorporated. Further, Customers must fully indemnify Diodes Incorporated and its representatives against any damages arising out of the use of Diodes Incorporated products in such safety-critical, life support devices or systems.

Copyright © 2011, Diodes Incorporated

www.diodes.com

单击下面可查看定价，库存，交付和生命周期等信息

[>>Diodes Incorporated\(达达科技\(美台\)\)](#)