

PNP SMALL SIGNAL SURFACE MOUNT TRANSISTOR

Features

- Epitaxial Planar Die Construction
- Complementary NPN Type Available (MMST4401)
- Ultra-Small Surface Mount Package
- "Lead Free", RoHS Compliant (Note 1)
- Halogen and Antimony Free. "Green" Device (Note 2)

Mechanical Data

- Case: SOT-323
- Case Material: Molded Plastic, "Green" Molding Compound, Note 4. UL Flammability Classification Rating 94V-0
- Moisture Sensitivity: Level 1 per J-STD-020
- Terminals: Solderable per MIL-STD-202, Method 208
- Lead Free Plating (Matte Tin Finish annealed over Alloy 42 leadframe).
- Weight: 0.006 grams (approximate)

SOT-323



Top view

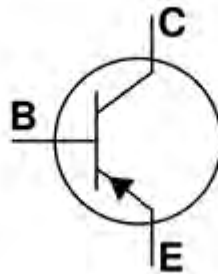

Device symbol

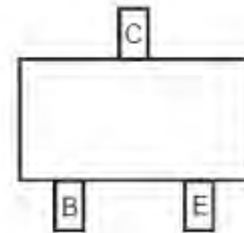

Pinout – top view

Ordering Information (Note 3)

Device	Packaging	Shipping
MMST4403-7-F	SOT-323	3000/Tape & Reel

- Notes:
1. No purposefully added lead.
 2. Diodes Inc's "Green" Policy can be found on our website at <http://www.diodes.com>
 3. For packaging details, go to our website at <http://www.diodes.com>

Marking Information

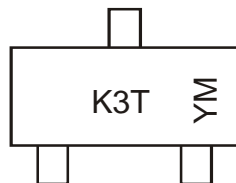

K3T = Product Type Marking Code
 YM = Date Code Marking
 Y = Year ex: N = 2002
 M = Month ex: 9 = September

Date Code Key

Year	2010	2011	2012	2013	2014	2015	2016	2017
Code	X	Y	Z	A	B	C	D	E

Month	Jan	Feb	Mar	Apr	May	Jun	Jul	Aug	Sep	Oct	Nov	Dec
Code	1	2	3	4	5	6	7	8	9	O	N	D

Maximum Ratings @T_A = 25°C unless otherwise specified

Characteristic	Symbol	Value	Unit
Collector-Base Voltage	V _{CB0}	-40	V
Collector-Emitter Voltage	V _{CEO}	-40	V
Emitter-Base Voltage	V _{EBO}	-5.0	V
Collector Current – Continuous (Note 4)	I _C	-600	mA
Power Dissipation (Note 4)	P _d	200	mW
Thermal Resistance, Junction to Ambient (Note 4)	R _{θJA}	625	K/W
Operating and Storage Temperature Range	T _j , T _{STG}	-55 to +150	°C

Notes: 4. Device mounted on FR-4 PCB, 1 inch x 0.85 inch x 0.062 inch;

Electrical Characteristics @T_A = 25°C unless otherwise specified

Characteristic	Symbol	Min	Max	Unit	Test Condition
OFF CHARACTERISTICS (Note 5)					
Collector-Base Breakdown Voltage	V _{(BR)CBO}	-40	—	V	I _C = -100μA, I _E = 0
Collector-Emitter Breakdown Voltage	V _{(BR)CEO}	-40	—	V	I _C = -1.0mA, I _B = 0
Emitter-Base Breakdown Voltage	V _{(BR)EBO}	-5.0	—	V	I _E = -100μA, I _C = 0
Collector Cutoff Current	I _{CEX}	—	-100	nA	V _{CE} = -35V, V _{EB(OFF)} = -0.4V
Base Cutoff Current	I _{BL}	—	-100	nA	V _{CE} = -35V, V _{EB(OFF)} = -0.4V
ON CHARACTERISTICS (Note 5)					
DC Current Gain	h _{FE}	30 60 100 100 20	— — — 300 —	—	I _C = -100μA, V _{CE} = -1.0V I _C = -1.0mA, V _{CE} = -1.0V I _C = -10mA, V _{CE} = -1.0V I _C = -150mA, V _{CE} = -2.0V I _C = -500mA, V _{CE} = -2.0V
Collector-Emitter Saturation Voltage	V _{CE(SAT)}	—	-0.40 -0.75	V	I _C = -150mA, I _B = -15mA I _C = -500mA, I _B = -50mA
Base-Emitter Saturation Voltage	V _{BE(SAT)}	-0.75 —	-0.95 -1.30	V	I _C = -150mA, I _B = -15mA I _C = -500mA, I _B = -50mA
SMALL SIGNAL CHARACTERISTICS					
Output Capacitance	C _{ob}	—	8.5	pF	V _{CB} = -10V, f = 1.0MHz, I _E = 0
Input Capacitance	C _{eb}	—	30	pF	V _{EB} = -0.5V, f = 1.0MHz, I _C = 0
Input Impedance	h _{ie}	1.5	15	kΩ	V _{CE} = -10V, I _C = -1.0mA, f = 1.0MHz
Voltage Feedback Ratio	h _{re}	0.1	8.0	x 10 ⁻⁴	
Small Signal Current Gain	h _{fe}	60	500	—	
Output Admittance	h _{oe}	1.0	100	μS	
Current Gain-Bandwidth Product	f _T	200	—	MHz	V _{CE} = -10V, I _C = -20mA, f = 100MHz
SWITCHING CHARACTERISTICS					
Delay Time	t _d	—	15	ns	V _{CE} = -30V, I _C = -150mA, V _{BE(OFF)} = -2.0V, I _{B1} = -15mA
Rise Time	t _r	—	20	ns	
Storage Time	t _s	—	225	ns	V _{CE} = -30V, I _C = -150mA, I _{B1} = I _{B2} = -15mA
Fall Time	t _f	—	30	ns	

Notes: 5. Short duration pulse test used to minimize self-heating effect

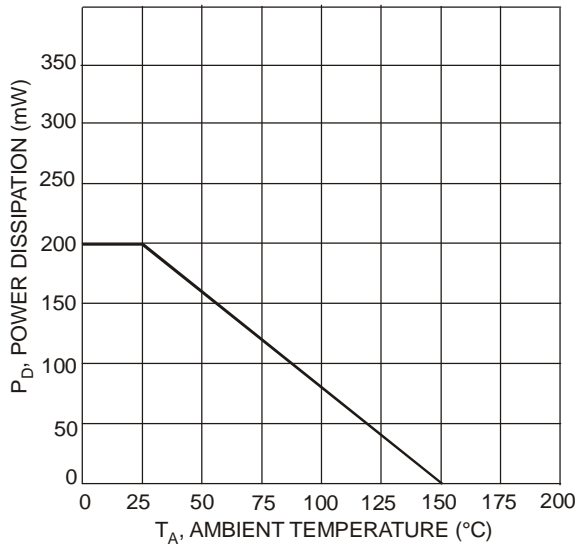

Fig. 1 Max Power Dissipation vs. Ambient Temperature

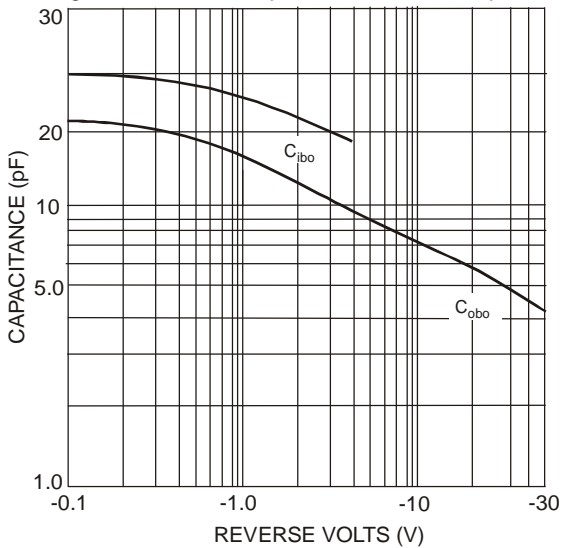

Fig. 3 Typical Capacitance

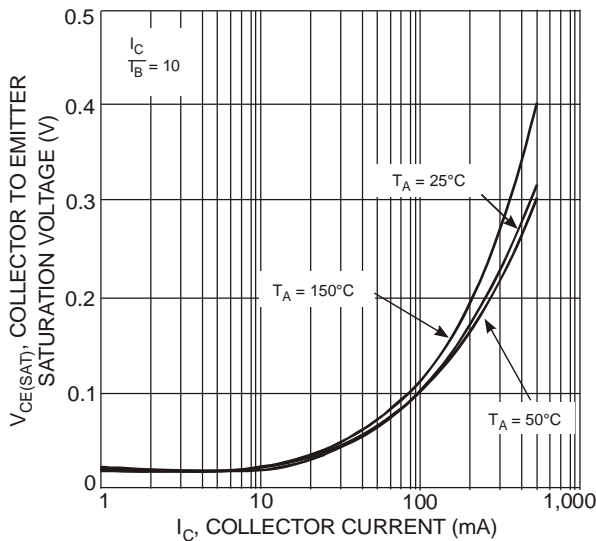

Fig. 5 Collector Emitter Saturation Voltage vs. Collector Current

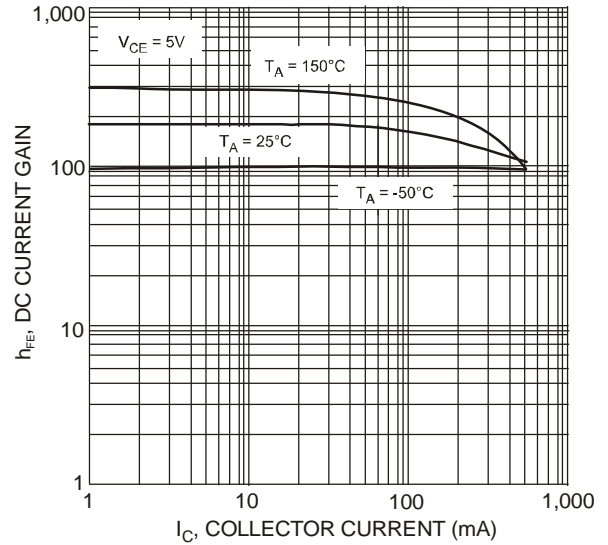

Fig. 2 DC Current Gain vs. Collector Current

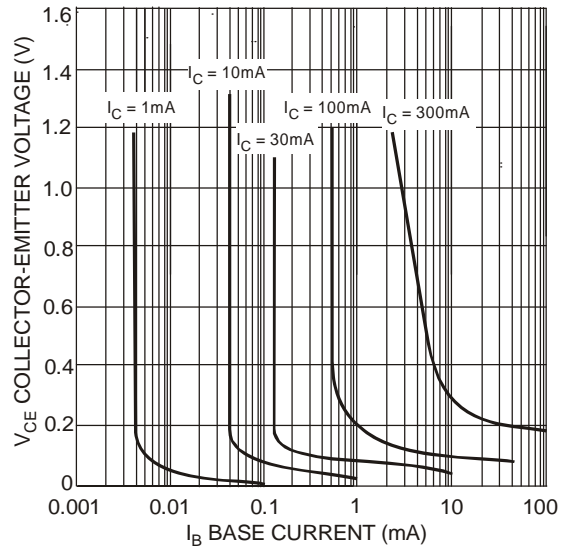

Fig. 4 Typical Collector Saturation Region

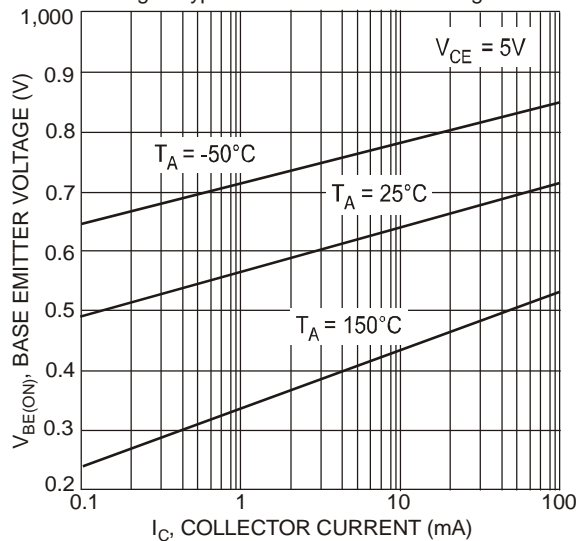

Fig. 6 Base-Emitter Voltage vs. Collector Current

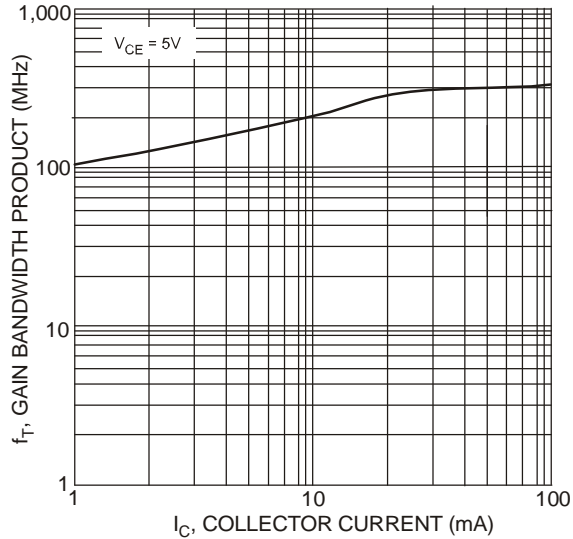
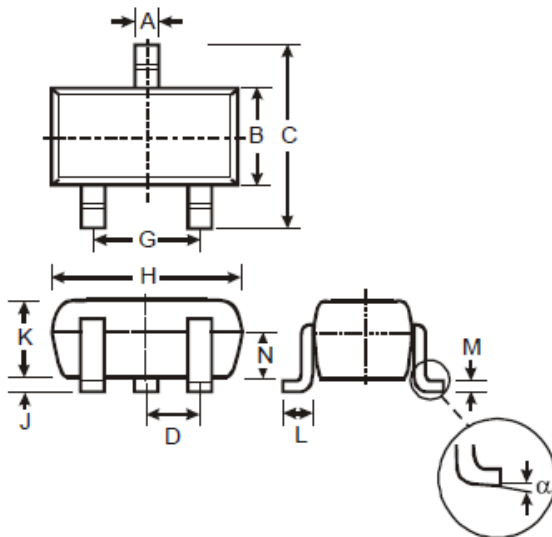

Fig. 7 Gain Bandwidth Product vs. Collector Current

Package Outline Dimensions



SOT-323			
Dim	Min	Max	Typ
A	0.25	0.40	0.30
B	1.15	1.35	1.30
C	2.00	2.20	2.10
D	-	-	0.65
G	1.20	1.40	1.30
H	1.80	2.20	2.15
J	0.0	0.10	0.05
K	0.90	1.00	1.00
L	0.25	0.40	0.30
M	0.10	0.18	0.11
N	-	-	-
α	0°	8°	-
All Dimensions in mm			

Suggested Pad Layout

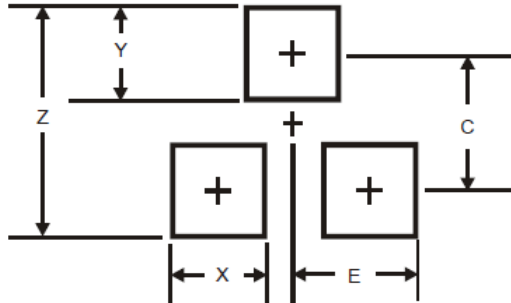

Dimensions	SOT-323
Z	2.8
X	0.7
Y	0.9
C	1.9
E	1.0

IMPORTANT NOTICE

DIODES INCORPORATED MAKES NO WARRANTY OF ANY KIND, EXPRESS OR IMPLIED, WITH REGARDS TO THIS DOCUMENT, INCLUDING, BUT NOT LIMITED TO, THE IMPLIED WARRANTIES OF MERCHANTABILITY AND FITNESS FOR A PARTICULAR PURPOSE (AND THEIR EQUIVALENTS UNDER THE LAWS OF ANY JURISDICTION).

Diodes Incorporated and its subsidiaries reserve the right to make modifications, enhancements, improvements, corrections or other changes without further notice to this document and any product described herein. Diodes Incorporated does not assume any liability arising out of the application or use of this document or any product described herein; neither does Diodes Incorporated convey any license under its patent or trademark rights, nor the rights of others. Any Customer or user of this document or products described herein in such applications shall assume all risks of such use and will agree to hold Diodes Incorporated and all the companies whose products are represented on Diodes Incorporated website, harmless against all damages.

Diodes Incorporated does not warrant or accept any liability whatsoever in respect of any products purchased through unauthorized sales channel. Should Customers purchase or use Diodes Incorporated products for any unintended or unauthorized application, Customers shall indemnify and hold Diodes Incorporated and its representatives harmless against all claims, damages, expenses, and attorney fees arising out of, directly or indirectly, any claim of personal injury or death associated with such unintended or unauthorized application.

Products described herein may be covered by one or more United States, international or foreign patents pending. Product names and markings noted herein may also be covered by one or more United States, international or foreign trademarks.

LIFE SUPPORT

Diodes Incorporated products are specifically not authorized for use as critical components in life support devices or systems without the express written approval of the Chief Executive Officer of Diodes Incorporated. As used herein:

- A. Life support devices or systems are devices or systems which:
 1. are intended to implant into the body, or
 2. support or sustain life and whose failure to perform when properly used in accordance with instructions for use provided in the labeling can be reasonably expected to result in significant injury to the user.
- B. A critical component is any component in a life support device or system whose failure to perform can be reasonably expected to cause the failure of the life support device or to affect its safety or effectiveness.

Customers represent that they have all necessary expertise in the safety and regulatory ramifications of their life support devices or systems, and acknowledge and agree that they are solely responsible for all legal, regulatory and safety-related requirements concerning their products and any use of Diodes Incorporated products in such safety-critical, life support devices or systems, notwithstanding any devices- or systems-related information or support that may be provided by Diodes Incorporated. Further, Customers must fully indemnify Diodes Incorporated and its representatives against any damages arising out of the use of Diodes Incorporated products in such safety-critical, life support devices or systems.

Copyright © 2011, Diodes Incorporated

www.diodes.com

单击下面可查看定价，库存，交付和生命周期等信息

[>>Diodes Incorporated\(达尔科技\)](#)