

Features

- 260 Watts Peak Pulse Power ($t_p = 8 \times 20 \mu s$)
- 61000-4-2 (ESD): Air – 30kV, Contact – 30kV
- MIL-STD 883(ESD), HBM – 10kV
- Low Reverse Leakage Current, $I_R < 1 \mu A$
- Unidirectional Configuration
- **Lead Free/RoHS Compliant (Note 3)**
- **“Green” Device (Note 4)**
- **Qualified to AEC-Q101 Standards for High Reliability**



Top View

Mechanical Data

- Case: SOT-23
- Case Material: Molded Plastic, “Green” Molding Compound, Note 3. UL Flammability Classification Rating 94V-0
- Moisture Sensitivity: Level 1 per J-STD-020
- Terminals: Matte Tin Finish annealed over Alloy 42 leadframe (Lead Free Plating). Solderable per MIL-STD-202, Method 208
- Ordering Information: See Page 2
- Marking Information: See Page 2
- Weight: 0.0089 grams (approximate)

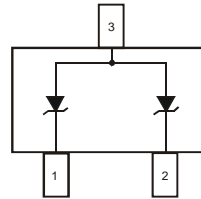

Device Schematic

Thermal Characteristics – Total Device

Characteristic	Symbol	Value	Unit
Peak Pulse Power ($t_p = 8 \times 20 \mu s$) (Note 6) $T_A = 25^\circ C$	P_{pk}	260	W
Thermal Resistance, Junction to Ambient (Note 6) $T_A = 25^\circ C$	$R_{\theta JA}$	417	$^\circ C/W$
Operating and Storage Temperature Range	T_J, T_{STG}	-65 to +150	$^\circ C$

Electrical Characteristics @ $T_A = 25^\circ C$ unless otherwise specified

Reverse Standoff Voltage	Breakdown Voltage V_{BR} @ I_T		Test Current I_T (mA)	Max. Reverse Leakage @ V_{RWM} (Note 5) I_R (μA)	Max. Clamping Voltage @ $I_{PP} = 1A$ (Note 2) V_C (V)	Max. Clamping Voltage V_C @ I_{PP} (Note 2)		Typical Total Capacitance C_T (Note 1) (pF)	Maximum Total Capacitance C_T (Note 1) (pF)
	Min (V)	Max (V)				V_C (V)	I_{PP} (A)		
V_{RWM} (V)	6.4	7.2	5.0	1	9	20	15	165	200

- Notes:
1. $V_R = 0V, f = 1MHz$.
 2. Clamping voltage value is based on an $8 \times 20 \mu s$ peak pulse current (I_{pp}) waveform.
 3. No purposefully added lead.
 4. Diodes Inc.'s “Green” policy can be found on our website at http://www.diodes.com/products/lead_free/index.php.
 5. Short duration pulse test used to minimize self-heating effect.
 6. Device mounted on FR-4 PC board with suggested pad layout, which can be found on our website at <http://www.diodes.com/datasheets/ap02001.pdf>.
 7. Measured across either pin 1 and pin 3 or pin 2 and pin 3.

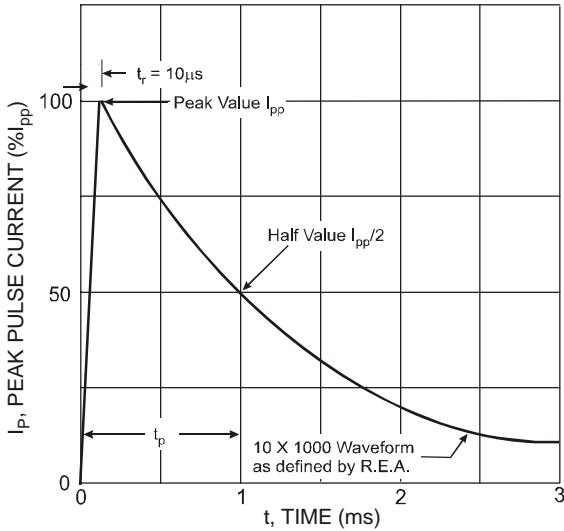

Fig. 1 Pulse Waveform

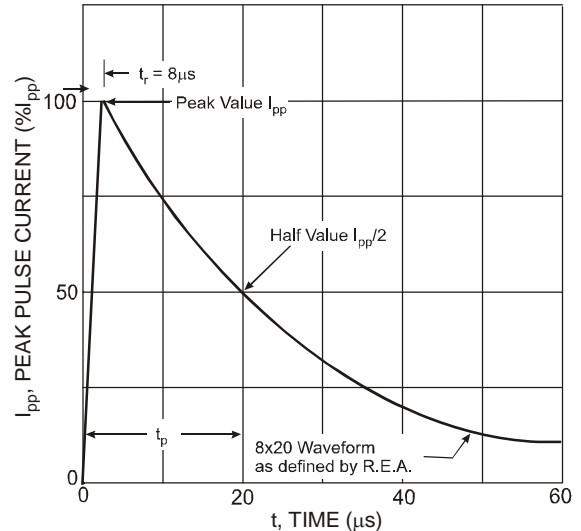

Fig. 2 Pulse Waveform

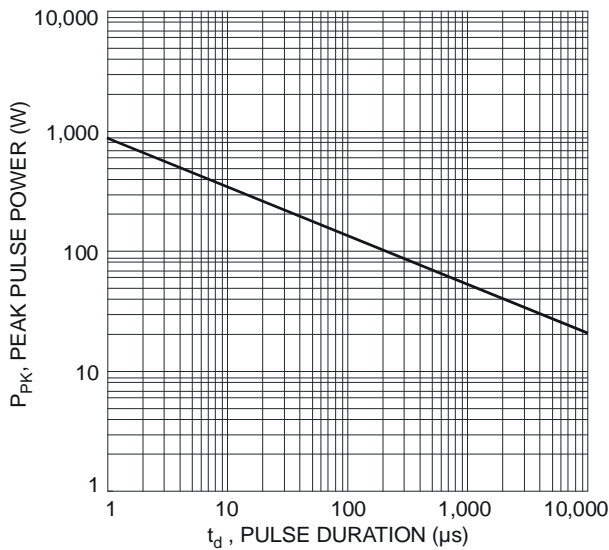

Fig. 3 Max. Peak Pulse Power vs. Pulse Duration

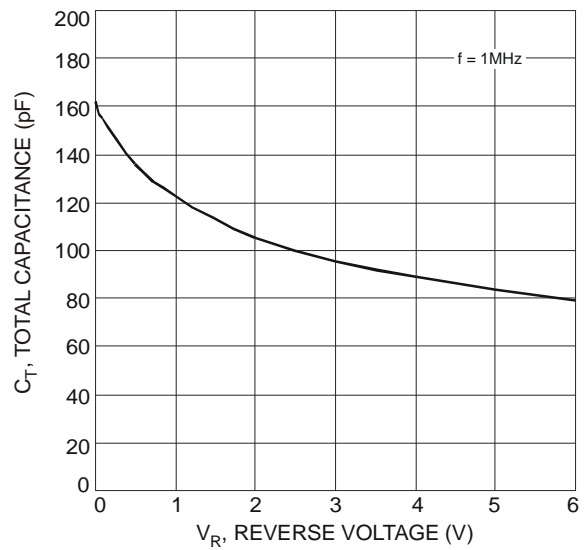

Fig. 4 Typical Total Capacitance vs. Reverse Voltage

Ordering Information (Note 8)

Part Number	Case	Packaging
DESD5V2S2UT-7	SOT-23	3000/Tape & Reel

Notes: 8. For packaging details, go to our website at <http://www.diodes.com/datasheets/ap02007.pdf>.

Marking Information

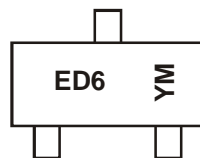

ED6 = Product Type Marking Code
 YM = Date Code Marking
 Y = Year (ex: W = 2009)
 M = Month (ex: 9 = September)

Date Code Key

Year	2009	2010	2011	2012	2013	2014	2015
Code	W	X	Y	Z	A	B	C

Month	Jan	Feb	Mar	Apr	May	Jun	Jul	Aug	Sep	Oct	Nov	Dec
Code	1	2	3	4	5	6	7	8	9	O	N	D

Package Outline Dimensions

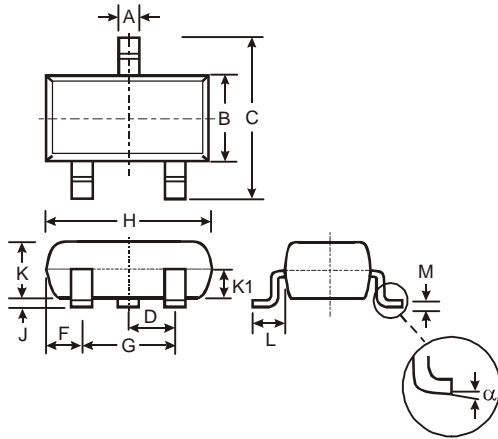

SOT-23			
Dim	Min	Max	Typ
A	0.37	0.51	0.40
B	1.20	1.40	1.30
C	2.30	2.50	2.40
D	0.89	1.03	0.915
F	0.45	0.60	0.535
G	1.78	2.05	1.83
H	2.80	3.00	2.90
J	0.013	0.10	0.05
K	0.903	1.10	1.00
K1	-	-	0.400
L	0.45	0.61	0.55
M	0.085	0.18	0.11
α	0°	8°	-
All Dimensions in mm			

Suggested Pad Layout

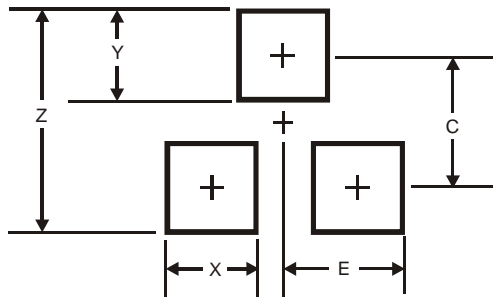

Dimensions	Value (in mm)
Z	2.9
X	0.8
Y	0.9
C	2.0
E	1.35

IMPORTANT NOTICE

DIODES INCORPORATED MAKES NO WARRANTY OF ANY KIND, EXPRESS OR IMPLIED, WITH REGARDS TO THIS DOCUMENT, INCLUDING, BUT NOT LIMITED TO, THE IMPLIED WARRANTIES OF MERCHANTABILITY AND FITNESS FOR A PARTICULAR PURPOSE (AND THEIR EQUIVALENTS UNDER THE LAWS OF ANY JURISDICTION).

Diodes Incorporated and its subsidiaries reserve the right to make modifications, enhancements, improvements, corrections or other changes without further notice to this document and any product described herein. Diodes Incorporated does not assume any liability arising out of the application or use of this document or any product described herein; neither does Diodes Incorporated convey any license under its patent or trademark rights, nor the rights of others. Any Customer or user of this document or products described herein in such applications shall assume all risks of such use and will agree to hold Diodes Incorporated and all the companies whose products are represented on Diodes Incorporated website, harmless against all damages.

Diodes Incorporated does not warrant or accept any liability whatsoever in respect of any products purchased through unauthorized sales channel. Should Customers purchase or use Diodes Incorporated products for any unintended or unauthorized application, Customers shall indemnify and hold Diodes Incorporated and its representatives harmless against all claims, damages, expenses, and attorney fees arising out of, directly or indirectly, any claim of personal injury or death associated with such unintended or unauthorized application.

Products described herein may be covered by one or more United States, international or foreign patents pending. Product names and markings noted herein may also be covered by one or more United States, international or foreign trademarks.

LIFE SUPPORT

Diodes Incorporated products are specifically not authorized for use as critical components in life support devices or systems without the express written approval of the Chief Executive Officer of Diodes Incorporated. As used herein:

A. Life support devices or systems are devices or systems which:

1. are intended to implant into the body, or
2. support or sustain life and whose failure to perform when properly used in accordance with instructions for use provided in the labeling can be reasonably expected to result in significant injury to the user.

B. A critical component is any component in a life support device or system whose failure to perform can be reasonably expected to cause the failure of the life support device or to affect its safety or effectiveness.

Customers represent that they have all necessary expertise in the safety and regulatory ramifications of their life support devices or systems, and acknowledge and agree that they are solely responsible for all legal, regulatory and safety-related requirements concerning their products and any use of Diodes Incorporated products in such safety-critical, life support devices or systems, notwithstanding any devices- or systems-related information or support that may be provided by Diodes Incorporated. Further, Customers must fully indemnify Diodes Incorporated and its representatives against any damages arising out of the use of Diodes Incorporated products in such safety-critical, life support devices or systems.

Copyright © 2009, Diodes Incorporated

www.diodes.com

单击下面可查看定价，库存，交付和生命周期等信息

[>>Diodes Incorporated\(达尔科技\)](#)