

Product Summary

$V_{(BR)DSS}$	$R_{DS(ON)}$	I_D $T_A = +25^\circ\text{C}$
60V	3.0Ω @ $V_{GS} = 10\text{V}$	400mA
	4.0Ω @ $V_{GS} = 5\text{V}$	330mA

Features and Benefits

- N-Channel MOSFET
- Low On-Resistance
- Low Gate-Threshold Voltage
- Low-Input Capacitance
- Fast Switching Speed
- Small-Surface Mount Package
- **ESD Protected Gate, 1.2kV HBM**
- **Totally Lead-Free & Fully RoHS Compliant (Notes 1 & 2)**
- **Halogen and Antimony Free. "Green" Device (Note 3)**
- **Qualified to AEC-Q101 Standards for High Reliability**

Description and Applications

This new generation MOSFET is designed to minimize the on-state resistance ($R_{DS(ON)}$) yet maintain superior switching performance, which makes it ideal for high-efficiency power-management applications.

- DC-DC Converters
- Power Management Functions
- Battery Operated Systems and Solid-State Relays
Drivers: Relays, Solenoids, Lamps, Hammers, Displays, Memories, Transistors, etc.

Mechanical Data

- Case: X1-DFN1006-3
- Case Material: Molded Plastic, "Green" Molding Compound; UL Flammability Classification Rating 94V-0
- Moisture Sensitivity: Level 1 per J-STD-020
- Terminal Connections: See Diagram
- Terminals: Finish—NiPdAu over Copper Leadframe; Solderable per MIL-STD-202, Method 208 (e4)
- Weight: 0.001 grams (Approximate)



X1-DFN1006-3

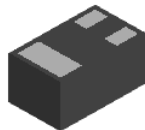

Bottom View

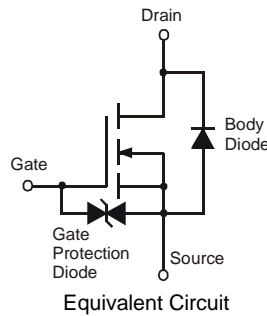

 Top View
Pin Configuration

Ordering Information (Note 4)

Part Number	Case	Packaging
DMN65D8LFB-7	X1-DFN1006-3	3000/Tape & Reel
DMN65D8LFB-7B	X1-DFN1006-3	10,000/Tape & Reel

- Notes:
1. No purposely added lead. Fully EU Directive 2002/95/EC (RoHS), 2011/65/EU (RoHS 2) & 2015/863/EU (RoHS 3) compliant.
 2. See <https://www.diodes.com/quality/lead-free/> for more information about Diodes Incorporated's definitions of Halogen- and Antimony-free, "Green" and Lead-free.
 3. Halogen- and Antimony-free "Green" products are defined as those which contain <900ppm bromine, <900ppm chlorine (<1500ppm total Br + Cl) and <1000ppm antimony compounds.
 4. For packaging details, refer to our website at <http://www.diodes.com>.

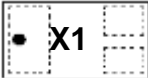
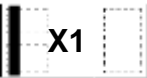
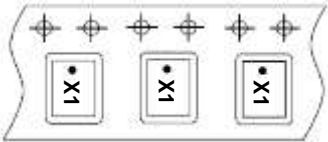
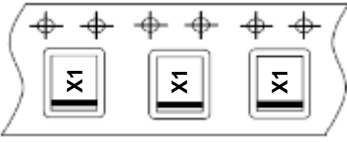
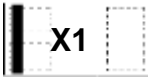
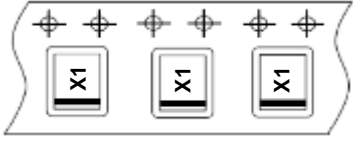
Marking Information

<p>DMN65D8LFB-7</p>	<div style="display: flex; justify-content: space-around; align-items: flex-start;"> <div style="text-align: center;">  <p>Top View Dot Denotes Drain Side</p> </div> <div style="text-align: center;"> <p>From date code 1527 (YYWW), this changes to:</p>  <p>Top View Bar Denotes Gate and Source Side</p> </div> </div> <div style="display: flex; justify-content: space-around; margin-top: 10px;">   </div>
<p>DMN65D8LFB-7B</p>	<div style="text-align: center; margin-bottom: 10px;">  <p>Top View Bar Denotes Gate and Source Side</p> </div> <div style="text-align: center; margin-bottom: 10px;"> <p>X1 = Part Marking Code</p> </div> <div style="text-align: center;">  </div>

Maximum Ratings

Characteristic			Symbol	Value	Units
Drain-Source Voltage			V_{DSS}	60	V
Gate-Source Voltage			V_{GSS}	± 20	V
Continuous Drain Current (Note 4) $V_{GS} = 10V$	Steady State	$T_A = +25^\circ C$	I_D	260	mA
		$T_A = +70^\circ C$		210	
Continuous Drain Current (Note 5) $V_{GS} = 10V$	Steady State	$T_A = +25^\circ C$	I_D	400	mA
		$T_A = +70^\circ C$		310	

Thermal Characteristics

Characteristic	Symbol	Value	Units
Power Dissipation, @ $T_A = +25^\circ C$ (Note 4)	P_D	430	mW
Thermal Resistance, Junction to Ambient @ $T_A = +25^\circ C$ (Note 4)	$R_{\theta JA}$	290	$^\circ C/W$
Power Dissipation, @ $T_A = +25^\circ C$ (Note 5)	P_D	840	mW
Thermal Resistance, Junction to Ambient @ $T_A = +25^\circ C$ (Note 5)	$R_{\theta JSA}$	147	$^\circ C/W$
Operating and Storage Temperature Range	T_J, T_{STG}	-55 to +150	$^\circ C$

Electrical Characteristics (@ $T_A = +25^\circ C$, unless otherwise specified.)

Characteristic	Symbol	Min	Typ	Max	Unit	Test Condition
OFF CHARACTERISTICS (Note 6)						
Drain-Source Breakdown Voltage	BV_{DSS}	60	—	—	V	$V_{GS} = 0V, I_D = 250\mu A$
Zero Gate Voltage Drain Current $T_J = +25^\circ C$	I_{DSS}	—	—	0.1	μA	$V_{DS} = 60V, V_{GS} = 0V$
Gate-Body Leakage	I_{GSS}	—	—	± 10	μA	$V_{GS} = \pm 20V, V_{DS} = 0V$
ON CHARACTERISTICS (Note 6)						
Gate Threshold Voltage	$V_{GS(th)}$	1.2	—	2.0	V	$V_{DS} = V_{GS}, I_D = 250\mu A$
Static Drain-Source On-Resistance	$R_{DS(on)}$	—	—	3.0 4.0	Ω	$V_{GS} = 10V, I_D = 0.115A$ $V_{GS} = 5V, I_D = 0.115A$
Forward Transfer Admittance	$ Y_{fs} $	80	320	—	mS	$V_{DS} = 10V, I_D = 0.115A$
Diode Forward Voltage	V_{SD}	—	0.7	1.2	V	$V_{GS} = 0V, I_S = 0.115A$
DYNAMIC CHARACTERISTICS (Note 7)						
Input Capacitance	C_{iss}	—	25	—	pF	$V_{DS} = 25V, V_{GS} = 0V, f = 1.0MHz$
Output Capacitance	C_{oss}	—	4.7	—	pF	
Reverse Transfer Capacitance	C_{rss}	—	2.5	—	pF	
Turn-On Delay Time	$t_{D(on)}$	—	3.27	—	ns	$V_{DD} = 30V, V_{GEN} = 10V,$ $R_{GEN} = 25\Omega, I_D = 0.115A$
Turn-On Rise Time	t_r	—	3.15	—	ns	
Turn-Off Delay Time	$t_{D(off)}$	—	12.025	—	ns	
Turn-Off Fall Time	t_f	—	6.29	—	ns	

- Notes:
- Device mounted on FR-4 PCB with minimum recommended pad layout, single-sided.
 - Device mounted on 2" x 2" FR-4 PCB with high coverage 2oz. Copper, single-sided.
 - Short duration pulse test used to minimize self-heating effect.
 - Guaranteed by design. Not subject to production testing.

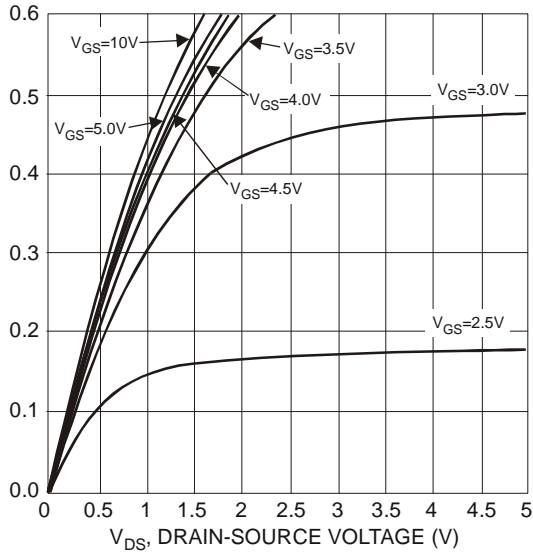

Fig. 1 Typical Output Characteristics

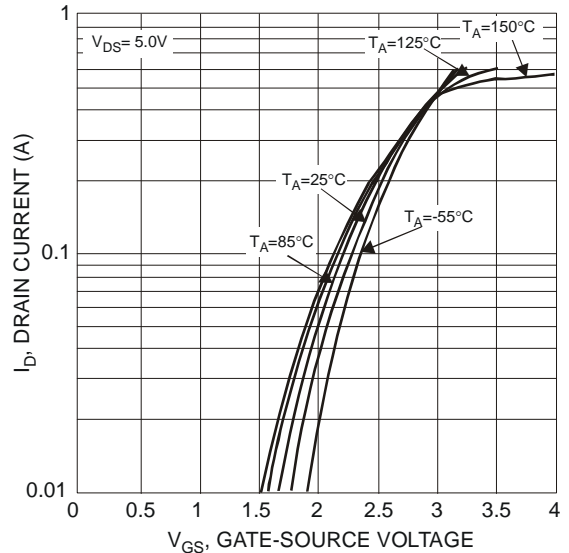

Fig. 2 Typical Transfer Characteristics

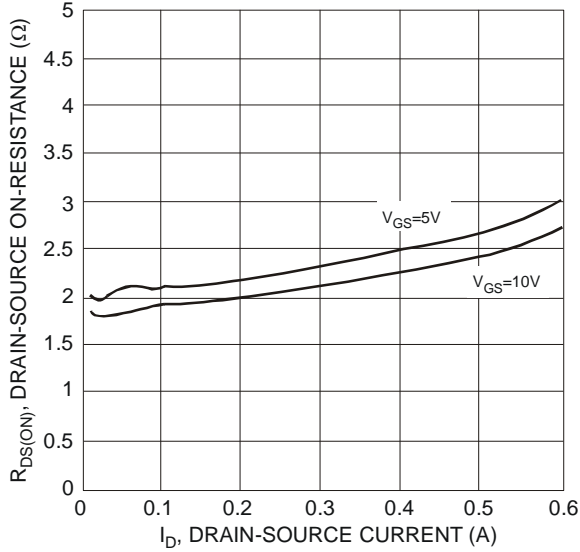

Fig. 3 Typical On-Resistance vs. Drain Current and Gate Charge

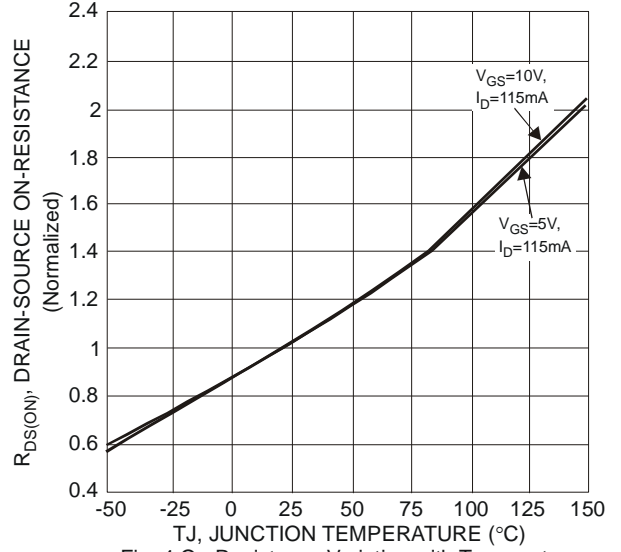

Fig. 4 On-Resistance Variation with Temperature

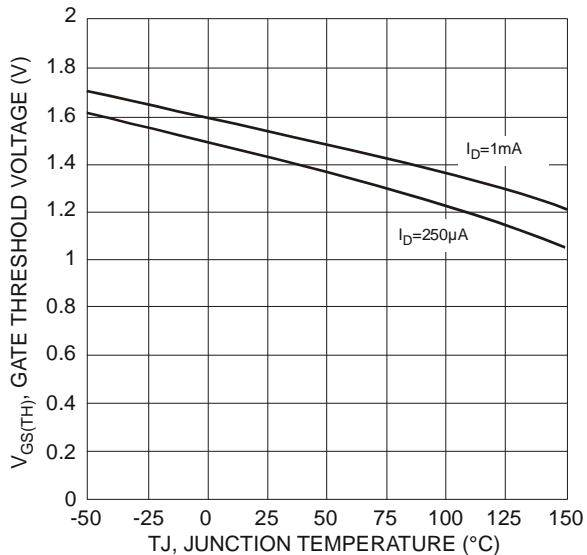

Fig. 5 Gate Threshold Variation vs. Ambient Temperature

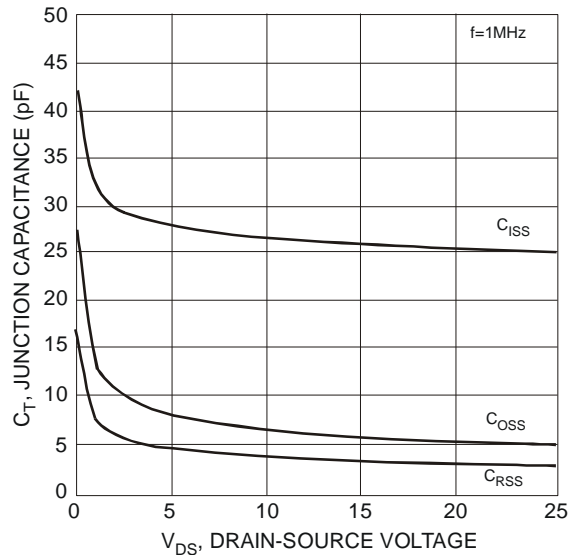

Fig. 6 Typical Junction Capacitance

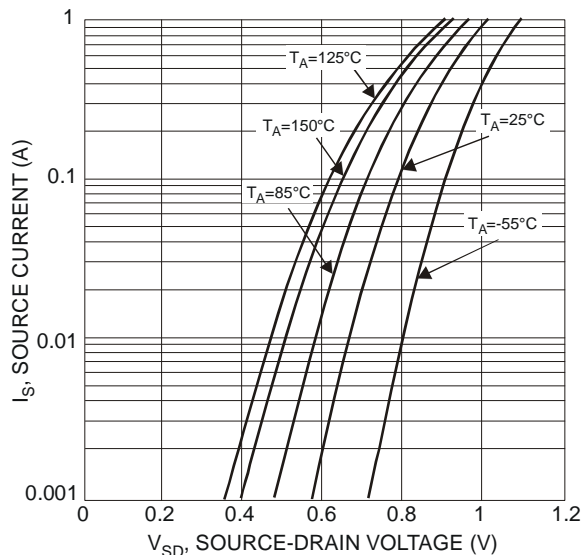
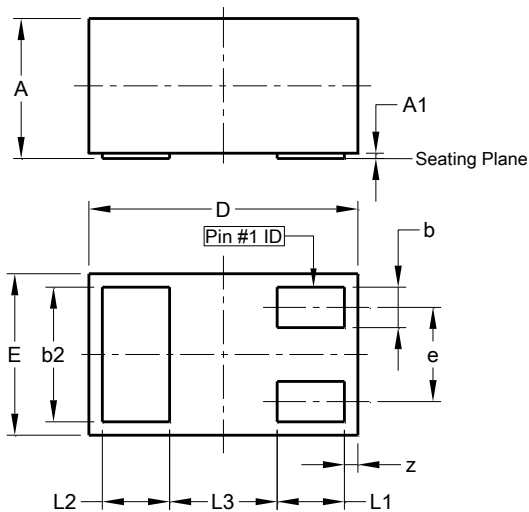

Fig. 7 Diode Forward Voltage vs. Current

Package Outline Dimensions

Please see <http://www.diodes.com/package-outlines.html> for the latest version.

X1-DFN1006-3



X1-DFN1006-3			
Dim	Min	Max	Typ
A	0.47	0.53	0.50
A1	0.00	0.05	0.03
b	0.10	0.20	0.15
b2	0.45	0.55	0.50
D	0.95	1.075	1.00
E	0.55	0.675	0.60
e	-	-	0.35
L1	0.20	0.30	0.25
L2	0.20	0.30	0.25
L3	-	-	0.40
z	0.02	0.08	0.05

All Dimensions in mm

Suggested Pad Layout

Please see <http://www.diodes.com/package-outlines.html> for the latest version.

X1-DFN1006-3

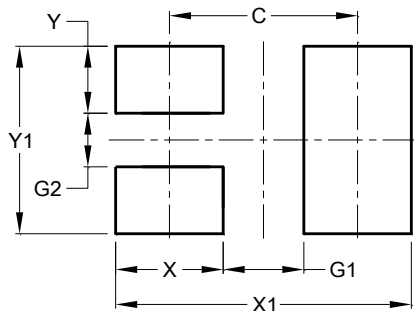

Dimensions	Value (in mm)
C	0.70
G1	0.30
G2	0.20
X	0.40
X1	1.10
Y	0.25
Y1	0.70

IMPORTANT NOTICE

DIODES INCORPORATED MAKES NO WARRANTY OF ANY KIND, EXPRESS OR IMPLIED, WITH REGARDS TO THIS DOCUMENT, INCLUDING, BUT NOT LIMITED TO, THE IMPLIED WARRANTIES OF MERCHANTABILITY AND FITNESS FOR A PARTICULAR PURPOSE (AND THEIR EQUIVALENTS UNDER THE LAWS OF ANY JURISDICTION).

Diodes Incorporated and its subsidiaries reserve the right to make modifications, enhancements, improvements, corrections or other changes without further notice to this document and any product described herein. Diodes Incorporated does not assume any liability arising out of the application or use of this document or any product described herein; neither does Diodes Incorporated convey any license under its patent or trademark rights, nor the rights of others. Any Customer or user of this document or products described herein in such applications shall assume all risks of such use and will agree to hold Diodes Incorporated and all the companies whose products are represented on Diodes Incorporated website, harmless against all damages.

Diodes Incorporated does not warrant or accept any liability whatsoever in respect of any products purchased through unauthorized sales channel. Should Customers purchase or use Diodes Incorporated products for any unintended or unauthorized application, Customers shall indemnify and hold Diodes Incorporated and its representatives harmless against all claims, damages, expenses, and attorney fees arising out of, directly or indirectly, any claim of personal injury or death associated with such unintended or unauthorized application.

Products described herein may be covered by one or more United States, international or foreign patents pending. Product names and markings noted herein may also be covered by one or more United States, international or foreign trademarks.

This document is written in English but may be translated into multiple languages for reference. Only the English version of this document is the final and determinative format released by Diodes Incorporated.

LIFE SUPPORT

Diodes Incorporated products are specifically not authorized for use as critical components in life support devices or systems without the express written approval of the Chief Executive Officer of Diodes Incorporated. As used herein:

A. Life support devices or systems are devices or systems which:

1. are intended to implant into the body, or
2. support or sustain life and whose failure to perform when properly used in accordance with instructions for use provided in the labeling can be reasonably expected to result in significant injury to the user.

B. A critical component is any component in a life support device or system whose failure to perform can be reasonably expected to cause the failure of the life support device or to affect its safety or effectiveness.

Customers represent that they have all necessary expertise in the safety and regulatory ramifications of their life support devices or systems, and acknowledge and agree that they are solely responsible for all legal, regulatory and safety-related requirements concerning their products and any use of Diodes Incorporated products in such safety-critical, life support devices or systems, notwithstanding any devices- or systems-related information or support that may be provided by Diodes Incorporated. Further, Customers must fully indemnify Diodes Incorporated and its representatives against any damages arising out of the use of Diodes Incorporated products in such safety-critical, life support devices or systems.

Copyright © 2018, Diodes Incorporated

www.diodes.com

单击下面可查看定价，库存，交付和生命周期等信息

[>>Diodes Incorporated\(达达科技\(美台\)\)](#)