

### Features

- Input voltage range: 2.2V~5.5V ( $V_{OUT}$  type)
- Oscillator frequency: 600KHz (Typ.)
- Internal reference: 1.0V (Typ.)
- High efficiency: 93% (Typ.)
- Stand-by capability:  $I_{STB}=2\mu A$ . (Typ.)
- Soft-start time set-up externally type possible
- Current limit and thermal shutdown protection
- Lead Free Package: SOT25
- SOT25: Available in "Green" Molding Compound (No Br, Sb)
- Lead Free Finish/ RoHS Compliant (Note 1)

### General Description

The AP1604A series are multi-functional step-down DC/DC converters with built-in speed, low ON resistance drivers. It is capable to deliver more than 800mA output current with external coil, diode and capacitor.

Output voltage is set-up by the external resistors. ( $\pm 2.5\%$  accuracy). The 600KHz AP1604A that can work out with small value external components comes out more compact board.

The device switches to and works under PFM mode with light loads. It keeps at high efficiency for both light loads and large output current.

AP1604A can be soft-start with a proper capacitor connected between CE/SS pin and ground. The stand-by current is less than 2uA when CE/SS pin is at "LOW" status. The device is forced to switch off as the voltage at that pin is lower than the stipulated voltage.

### Applications

- Electronic Information Organizers
- Palmtops
- Cellular and portable phones
- Portable Audio Systems
- Various Multi-function Power Supplies

### Ordering Information

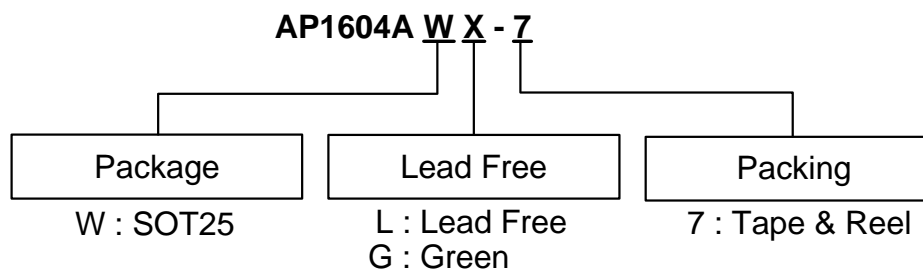

Device	Package Code	Packaging (Note 2)	7" Tape and Reel	
			Quantity	Part Number Suffix
AP1604AWL-7	W	SOT25	3000/Tape & Reel	-7
AP1604AWG-7	W	SOT25	3000/Tape & Reel	-7



- Notes: 1. EU Directive 2002/95/EC (RoHS). All applicable RoHS exemptions applied. Please visit our website at [http://www.diodes.com/products/lead\\_free.html](http://www.diodes.com/products/lead_free.html).
2. Pad layout as shown on Diodes Inc. suggested pad layout document AP02001, which can be found on our website at <http://www.diodes.com/datasheets/ap02001.pdf>.

**Pin Assignment**

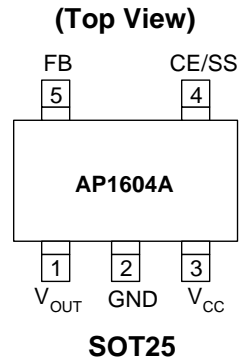

**Pin Description**

Pin Name	Description
V <sub>OUT</sub>	Output Voltage
GND	Ground
V <sub>CC</sub>	Input Supply
CE/SS	Chip Enable / Soft Start
FB	Feedback pin

**Block Diagram**

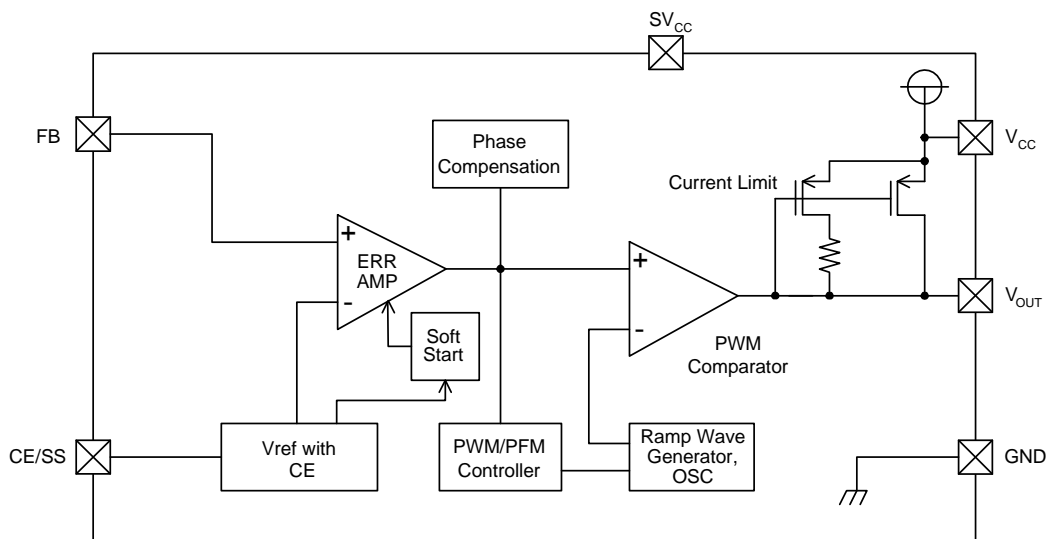

### Absolute Maximum Ratings (T<sub>A</sub>=25°C)

Symbol	Parameter	Ratings	Units
V <sub>CC</sub> /SV <sub>CC</sub>	V <sub>IN</sub> Pin Voltage	-0.3 ~ 6.5	V
V <sub>OUT</sub>	V <sub>OUT</sub> Pin Voltage	-0.3 ~ V <sub>IN</sub> +0.3	V
V <sub>FB</sub>	FB Pin Voltage	-0.3 ~ V <sub>IN</sub> +0.3	V
V <sub>CE/SS</sub>	CE/SS Pin Voltage	-0.3 ~ V <sub>IN</sub> +0.3	V
P <sub>D</sub>	Continuous Total Power Dissipation	Internal limited	
T <sub>OP</sub>	Operating Ambient Temperature	-25 ~ +80	°C
T <sub>ST</sub>	Storage Temperature Range	-40 ~ +125	°C

### Electrical Characteristics

V<sub>IN</sub> = 5V, V<sub>OUT</sub> = 2V, Load = 300mA, T<sub>A</sub> = 25°C

Sym.	Parameter	Conditions	Min	Typ.	Max	Units
V <sub>FB</sub>	FB		0.975	1.0	1.025	V
V <sub>IN</sub>	Input Voltage		2.2	-	5.5	V
	Line Regulation	V <sub>IN</sub> = 2.2 ~ 5.5V, Load = 10mA	-	-	0.12	%
	Load Regulation	I <sub>OUT</sub> = 10 ~ 800mA	-	-	1.2	%
V <sub>UVLO</sub>	UVLO Voltage (min. operating voltage)	V <sub>CC</sub> , voltage required to maintain H at V <sub>OUT</sub>	-	-	2	V
I <sub>CC</sub>	Operating Current	CE/SS = V <sub>IN</sub> , No Load	-	100	150	μA
I <sub>CCQ</sub>	Supply Current	No external components, CE/SS = V <sub>IN</sub> , V <sub>FB</sub> = 1.2V	-	90	120	μA
I <sub>STB</sub>	Stand-by Current	No external components, CE/SS = 0V, V <sub>FB</sub> = 0V	-	2	-	μA
I <sub>CL</sub>	Current Limit	peak current V <sub>IN</sub> = 5V, V <sub>OUT</sub> = 2V	800	1000	1200	mA
Fosc	Oscillator Frequency	Load = 300mA, V <sub>IN</sub> = 5V, V <sub>OUT</sub> = 2V	500	600	700	kHz
MAXDTY	Maximum Duty Ratio		85	90	-	%
PFMDTY	PFM Duty Ratio	No load	15	25	35	%
V <sub>CEH</sub>	CE/SS "High" Voltage	Apply 1.4V (min.) to CE/SS, determine V <sub>OUT</sub> "High"	1.4	-	-	V
V <sub>CEL</sub>	CE/SS "Low" Voltage	Same as V <sub>CEH</sub> , determine V <sub>OUT</sub> "Low"	-	-	0.6	V
EFFI	Efficiency	V <sub>CC</sub> = 5V, V <sub>OUT</sub> = 3.3V, Load = 300mA	-	93	-	%
Rdson	Rdson Condition	I <sub>OUT</sub> = 300mA, V <sub>IN</sub> = 5V, V <sub>OUT</sub> = 2V	-	350	450	mΩ

**Typical Performance Characteristics**

**Vcc vs. Operating Current**

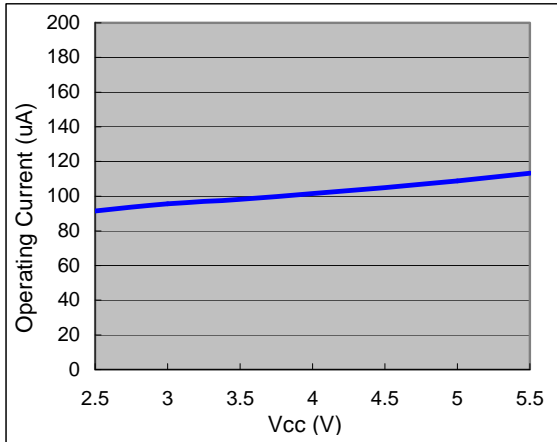

**Vcc vs. Quiescent Current**

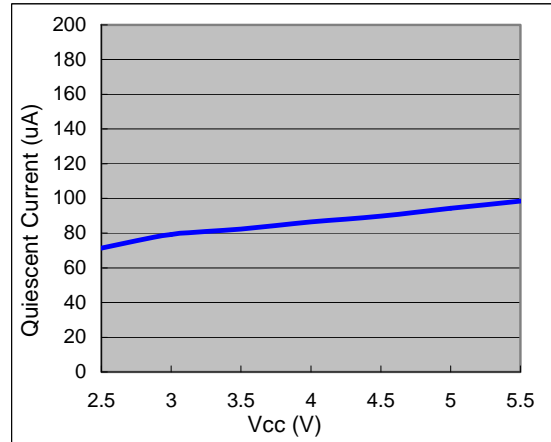

**Vcc vs. Stand-by Current**

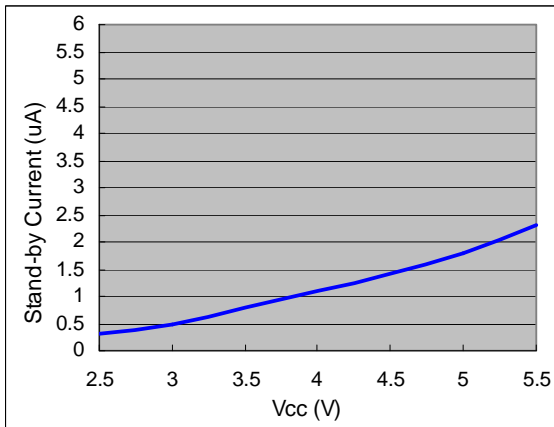

**Vcc vs. Frequency**

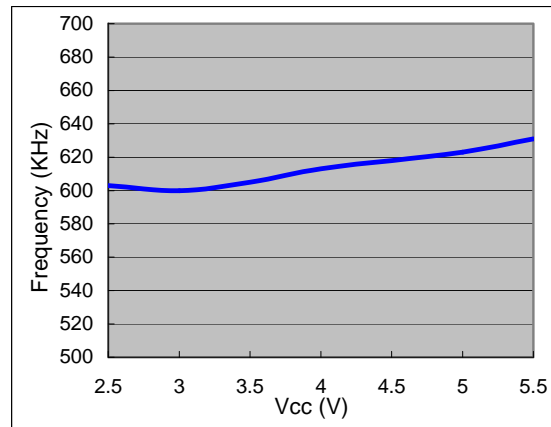

**Vcc vs. Current Limit**

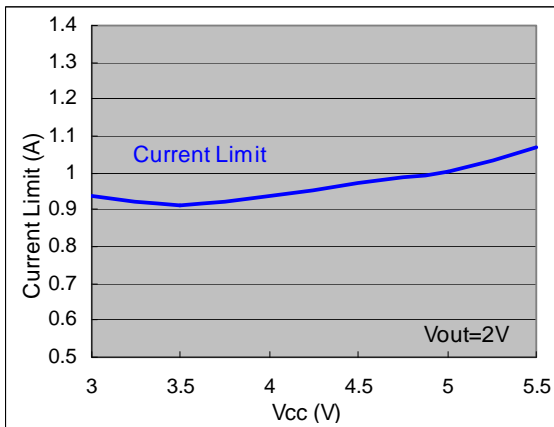

**Vcc vs. R<sub>DS(ON)</sub>**

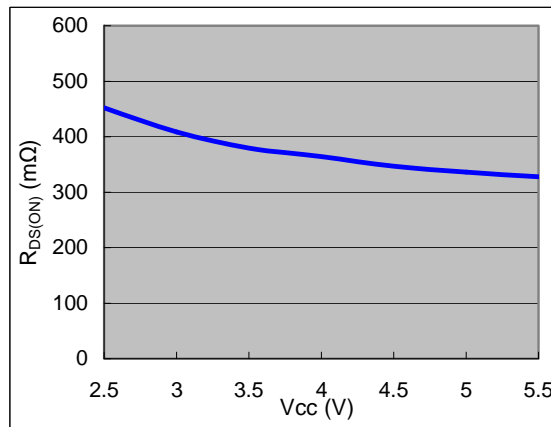

**Typical Performance Characteristics (Continued)**

**Line Regulation**

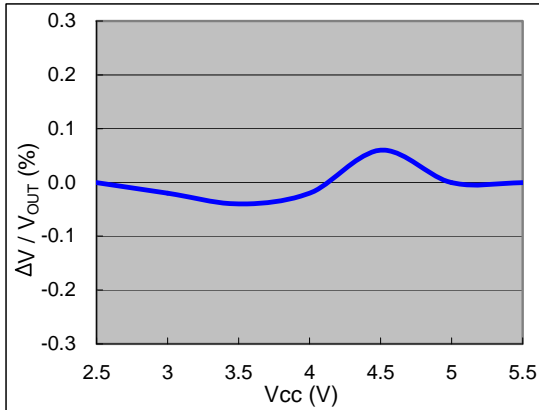

**Load Regulation**

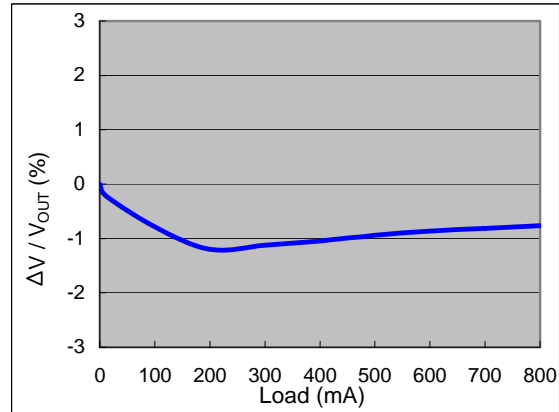

**Typical Application Circuit**

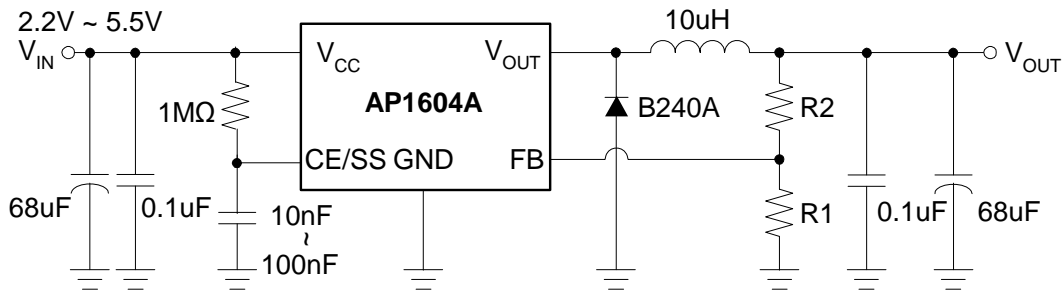

$$V_{out} = 1 \times \left( 1 + \frac{R2}{R1} \right)$$

$$R1 = 100K \sim 200K$$

**Marking Information**

(1) SOT25

( Top View )

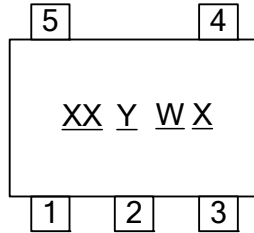

XX : Identification code  
Y : Year 0~9  
W : Week : A~Z : 1~26 week;  
a~z : 27~52 week; z represents  
52 and 53 week  
X : a~z : Lead Free  
A~Z : Green

Part Number	Package	Identification Code
AP1604AW	SOT25	ER

**Package Information (All Dimensions in mm)**

(1) Package Type: SOT25

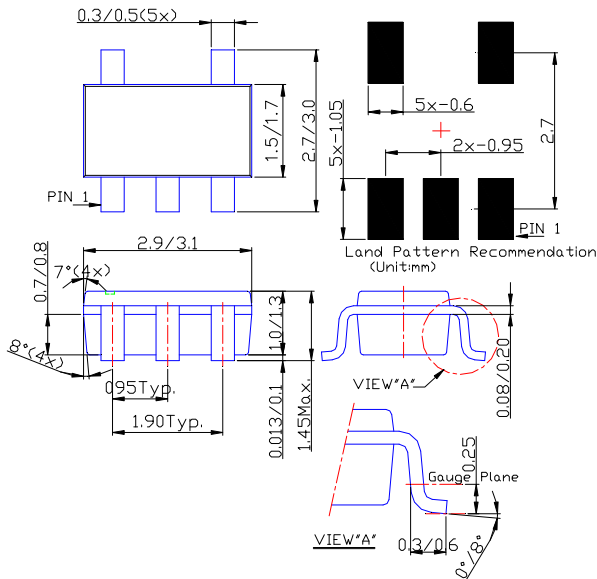

**IMPORTANT NOTICE**

Diodes Incorporated and its subsidiaries reserve the right to make modifications, enhancements, improvements, corrections or other changes without further notice to any product herein. Diodes Incorporated does not assume any liability arising out of the application or use of any product described herein; neither does it convey any license under its patent rights, nor the rights of others. The user of products in such applications shall assume all risks of such use and will agree to hold Diodes Incorporated and all the companies whose products are represented on our website, harmless against all damages.

**LIFE SUPPORT**

Diodes Incorporated products are not authorized for use as critical components in life support devices or systems without the expressed written approval of the President of Diodes Incorporated.

单击下面可查看定价，库存，交付和生命周期等信息

[>>Diodes Incorporated\(达达科技\(美台\)\)](#)