



A Product Line of
Diodes Incorporated



SPECIFICATION FOR APPROVAL

CUSTOMER _____

NOMINAL FREQUENCY 156.250000 MHz

HOLDER TYPE TYPE SK 3.2x2.5 SEAM SEALED CRYSTAL CLOCK OSCILLATOR

SPEC. NO. (P/N) SKF620002

CUSTOMER P/N _____

ISSUE DATE December 18, 2017

VERSION D

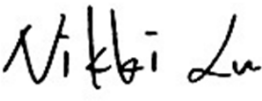
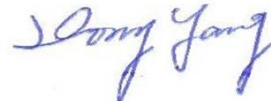
APPROVED	PREPARED	QA
		

Diodes Incorporated

No.2, Ziqiang 5th Rd., Zhongli Industrial Park,
Zhongli Dist., Taoyuan City 32063, Taiwan (R.O.C.)
TEL: 886-3-451-8888
FAX: 886-3-461-3865
<https://www.diodes.com>

*Pb-free
*RoHS Compliant
*HF-Halogen Free
*REACH Compliant

TYPE SK 3.2x2.5 SEAM SEALED CRYSTAL CLOCK OSCILLATOR

SKF620002

VER. D 18-Dec-17

VERSION HISTORY

Version No.	Version Date	Description	Notes
A	Sep.11,2014	Initial Release	
B	Aug.2,2017	Changed Logo	
C	Nov.13,2017	Updated logo	
D	Dec.18,2017	Added the note of Bottom View on mechanical drawing.	



TYPE SK 3.2x2.5 SEAM SEALED CRYSTAL CLOCK OSCILLATOR

SKF620002

VER. D 18-Dec-17

ELECTRICAL SPECIFICATIONS

SRe Part Number : SKF620002

Item	Symbol	Specifications	Units	Notes
Nominal Frequency	Fo	156.250000	MHz	
Frequency Stability	FT	± 50	ppm	**See note
Operating Temperature Range	TR	-40 to +85	°C	
Supply Voltage	V _{CC}	+3.3 ± 10.0%	V	
Logic Type	LT	HCSL		
Supply Current, Output Enabled	I _{CC/OE}	40	mA	Max.
Supply Current, Output Disabled	I _{CC/OD}	10	µA	Max.
Duty Cycle (Symmetry)	DC/SY	45 / 55	%	Measured 50% of Waveform
Rise / Fall Time	T _R /T _F	500	ps	Max. measured 20/80% of Waveform
Output Voltage "0" Level	V _{OL}	-0.150	V	Min.
Output Voltage "1" Level	V _{OH}	0.900	V	Max.
Output Load		Rs=33Ω, Rp=50Ω, CL=2pF		Typ. In HCSL termination
Jitter, Phase	RMS	0.2	ps	Max. 12KHz ~ 20MHz Frequency Band
Jitter, Peak to Peak	Pk-Pk	40	ps	Max. 100,000 Random Periods
Start Up Time		10	ms	Max.
Storage Temperature Range		-55 to +125	°C	

※ This product doesn't include harmful substance that stipulated by SONY SS-00259 Level 1 and S-AT2-001 Level 1 standard. RoHS Compliant (Pb - Free).

**Stability includes all combinations of Operating Temperature, Load changes, rated Input (Supply) Voltage changes, Initial Calibration Tolerance (25°C), Aging (5 years at 40°C Average Effective Ambient Temperature), Shock and Vibration.

OUTPUT ENABLE / DISABLE

Parameter	Min.	Typ.	Max.	Units	Notes
Input Voltage (Pin1), Output Enable	0.7V _{CC}			V	Or Open
Input Voltage (Pin1), Output Disable (low power standby)			0.3V _{CC}	V	Output is Hi-Z
Output Disable Delay			0.2	µs	
Output Enable Delay			2	ms	



TYPE SK 3.2x2.5 SEAM SEALED CRYSTAL CLOCK OSCILLATOR

SKF620002

VER. D 18-Dec-17

TEST CIRCUIT

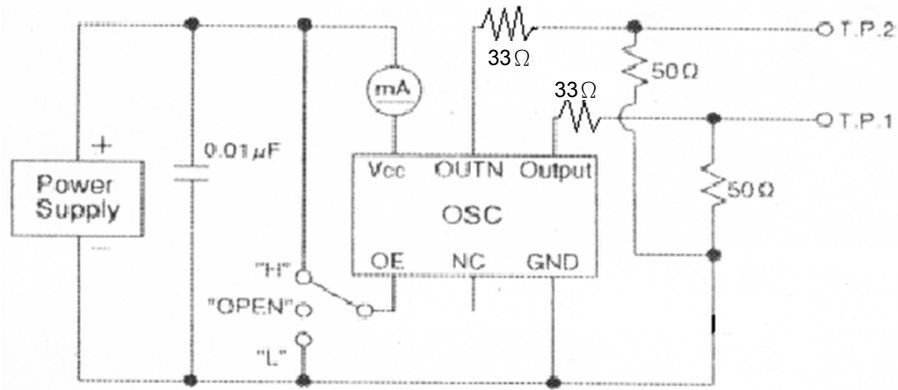

OUTPUT WAVEFORM

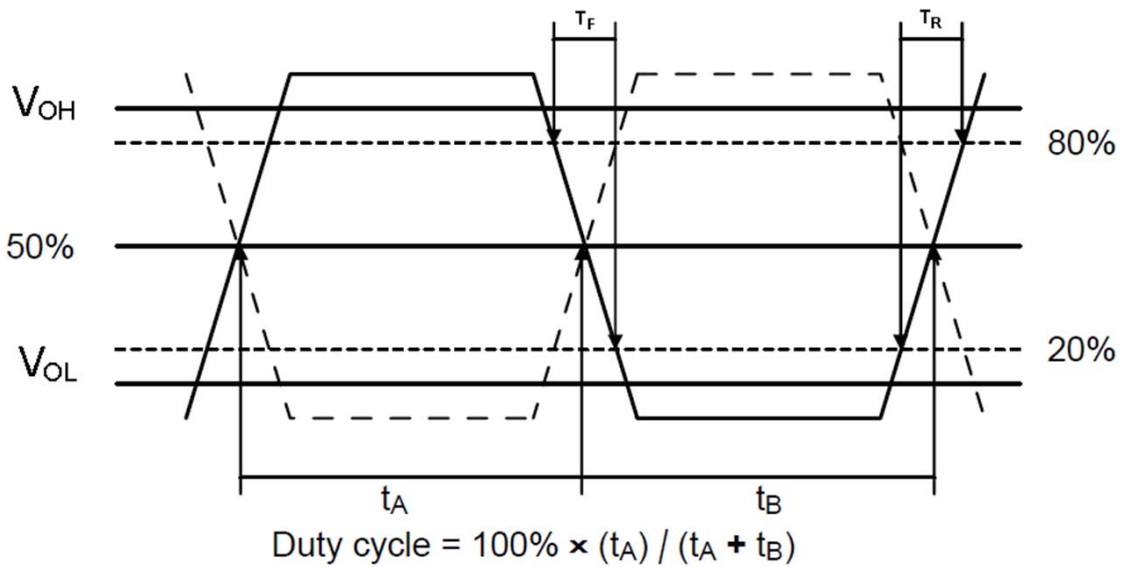

TYPE SK 3.2x2.5 SEAM SEALED CRYSTAL CLOCK OSCILLATOR

SKF620002

VER. D 18-Dec-17

RELIABILITY SPECIFICATIONS

ENVIRONMENTAL:

- a) THERMAL SHOCK: MIL-STD-883, Method 1011, Condition A
- b) MOISTURE RESISTANCE: MIL-STD-883, Method 1004
- c) VIBRATION: MIL-STD-883, Method 2007, Condition A
- d) RESISTANCE TO SOLDERING HEAT: J-STD-020D Table 5-2 Pb-free devices (except 2 cycles max)
- e) HAZARDOUS SUBSTANCE: RoHS Compliant

MECHANICAL:

- a) SHOCK: MIL-STD-883, Method 2002, Condition B
- b) SOLDERABILITY: JESD22-B102-D Method 2 (Preconditioning E)
- c) TERMINAL STRENGTH: MIL-STD-883, Method 2004, Test Condition D
- d) GROSS LEAK: MIL-STD-883, Method 1014, Condition C
- e) FINE LEAK: MIL-STD-883, Method 1014, Condition A2, $R1=2 \times 10^{-8}$ atm cc/s
- f) SOLVENT RESISTANCE: MIL-STD-202, Method 215

SUGGESTED IR REFLOW PROFILE

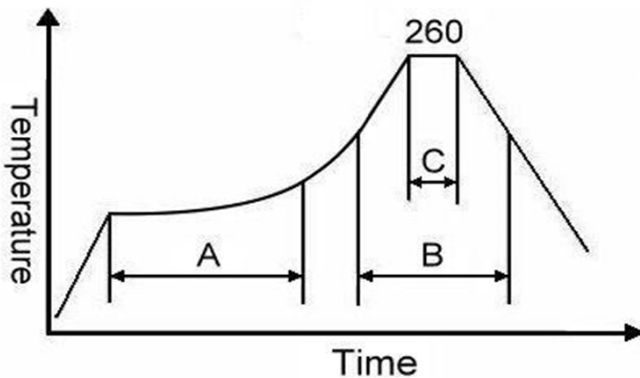

Note:

	Stage	Temperature	Time
A	Preheat	150~200°C	60~120 Sec
B	Primary Heat	217°C	60~150 Sec
C	Peak	260°C	10 Sec

TYPE SK 3.2x2.5 SEAM SEALED CRYSTAL CLOCK OSCILLATOR

SKF620002

VER. D 18-Dec-17

MARKING

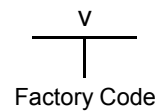
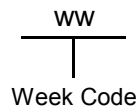
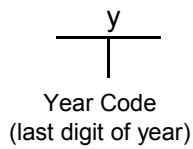

MECHANICAL DRAWINGS (Scale:None. Dimensions are in mm.)

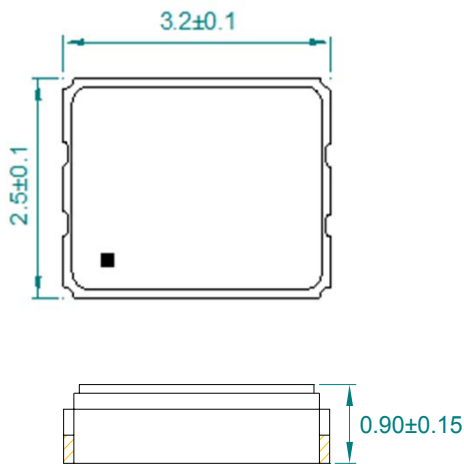

Recommended Land Pattern*

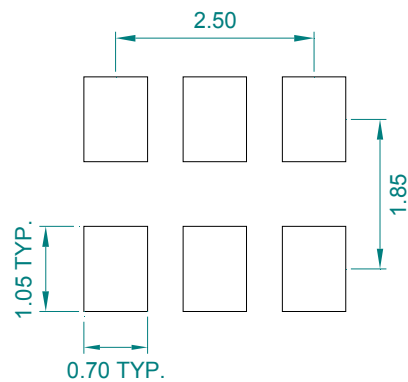

*External high-frequency power decoupling is recommended. (see test circuit for minimum recommendation). To ensure optimal performance, do not route traces beneath the package.

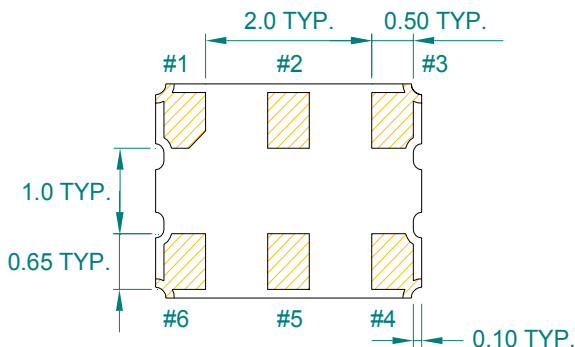

Bottom View

Pin	Function
1	OE
2	NC
3	V _{EE}
4	OUTPUT
5	OUTPUT N
6	V _{CC}

TYPE SK 3.2x2.5 SEAM SEALED CRYSTAL CLOCK OSCILLATOR

SKF620002

VER. D 18-Dec-17

TAPE&REEL

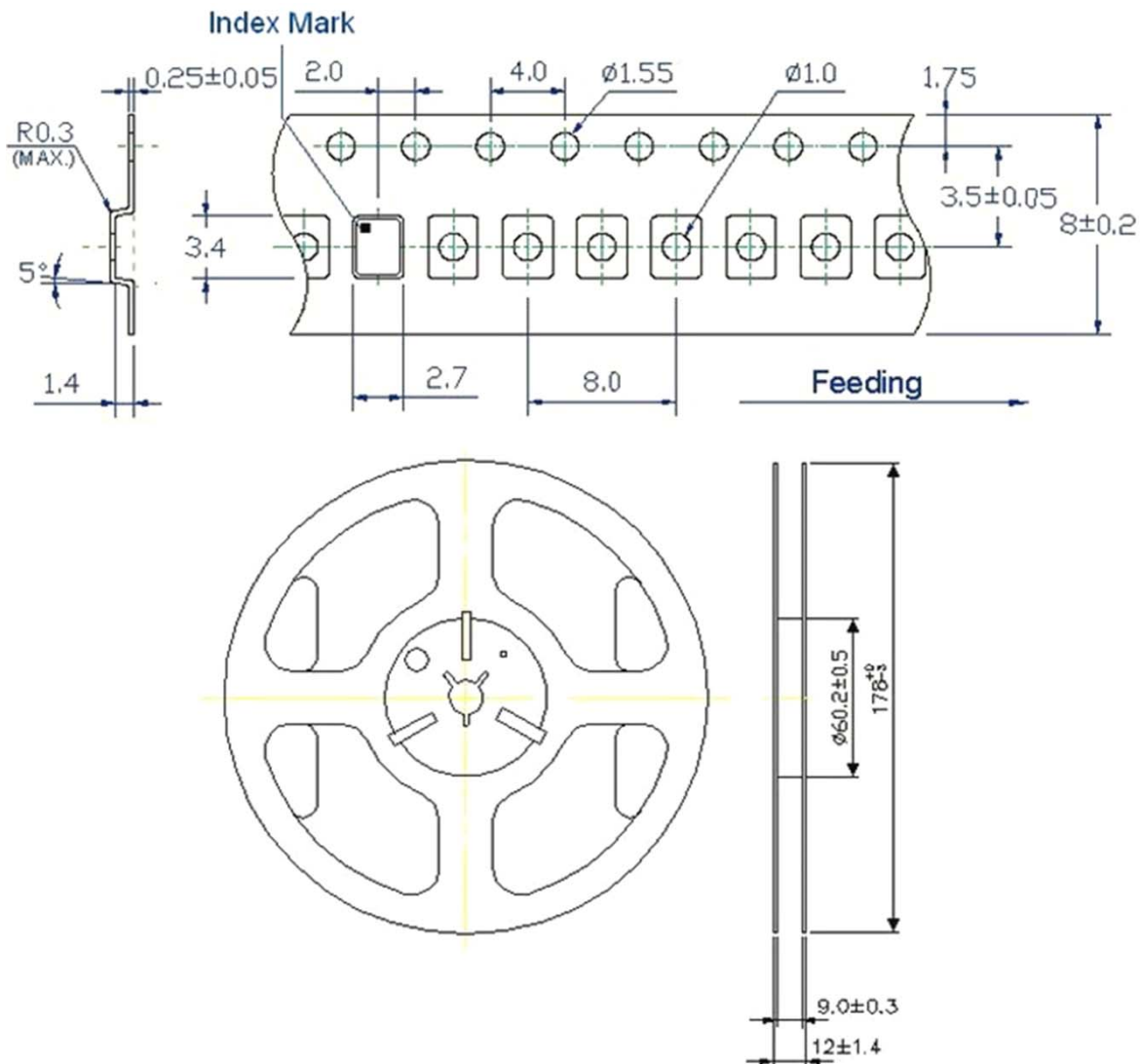

1. 230mm minimum leader which consist of carrier and/or tape followed by a minimum of 160mm of empty carrier tape sealed with cover tape.
2. 160mm minimum trailer of empty carrier tape sealed with cover tape.



TYPE SK 3.2x2.5 SEAM SEALED CRYSTAL CLOCK OSCILLATOR

SKF620002

VER. D 18-Dec-17

PACKING

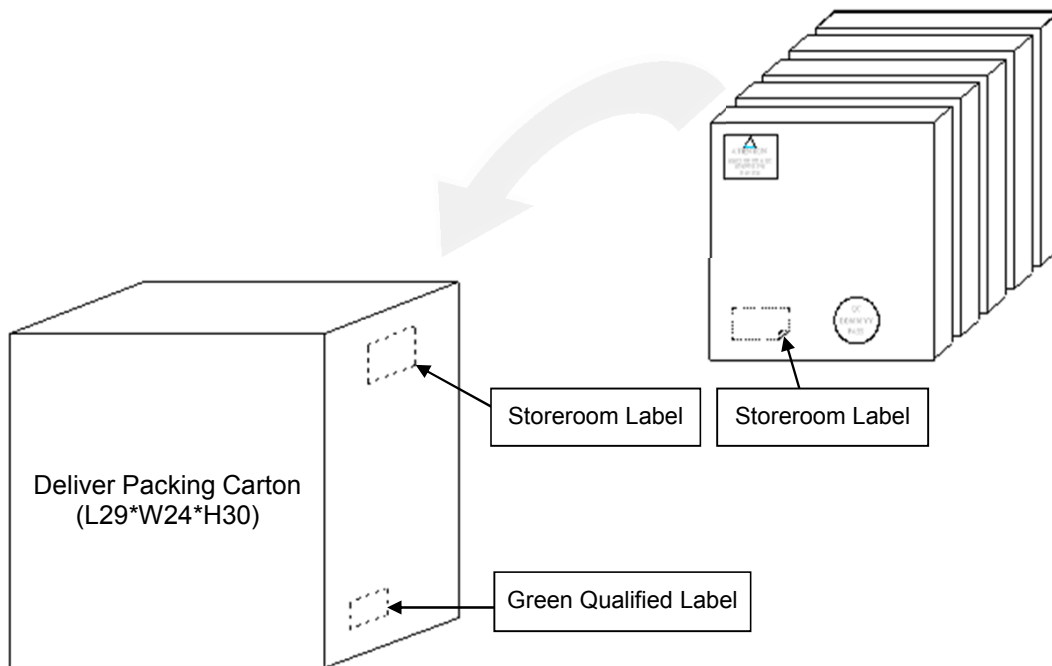
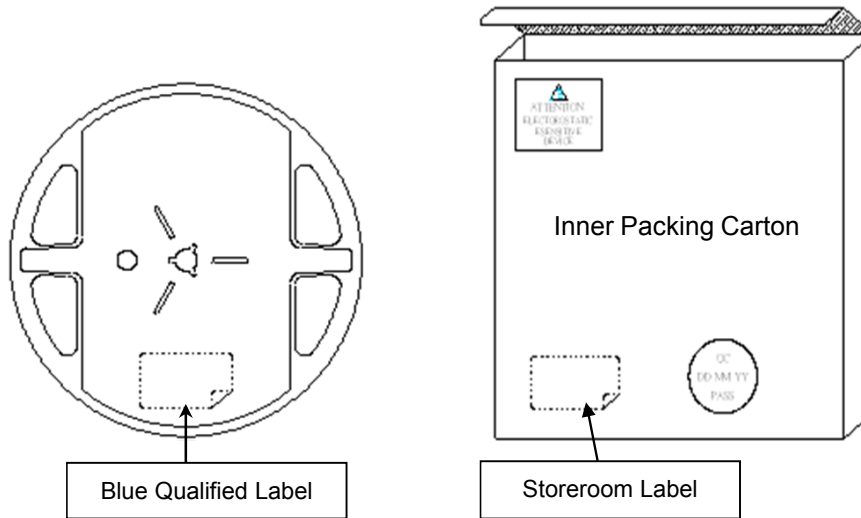
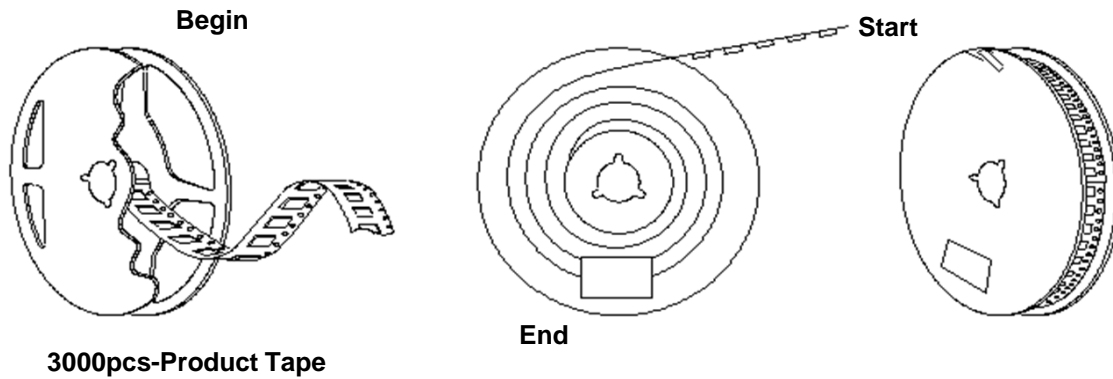

单击下面可查看定价，库存，交付和生命周期等信息

[>>Diodes Incorporated\(达达科技\(美台\)\)](#)