

**Description**

The AP7173 is a 1.5A low-dropout (LDO) linear regulator that features a user-programmable soft-start, an enable input and a power-good output.

The soft-start reduces inrush current of the load capacitors and minimizes stress on the input power source during start-up. The enable input and power-good output allow users to configure power management solutions that can meet the sequencing requirements of FPGAs, DSPs, and other applications with different start-up and power-down requirements.

The AP7173 is stable with any type of output capacitor of 2.2µF or more. A precision reference and feedback control deliver 2% accuracy over load, line, and operating temperature ranges. The AP7173 is available in both DFN3030-10 and SO-8EP packages.

**Features**

- Low  $V_{IN}$  and wide  $V_{IN}$  range: 1.0V to 5.5V
- Bias voltage ( $V_{VCC}$ ) range: 2.7V to 5.5V
- Low  $V_{OUT}$  range: 0.8V to 3.3V
- Low dropout: 165mV typical at 1.5A,  $V_{VCC} = 5V$
- 2% accuracy over line, load and temperature range
- Power-Good (PG) output for supply monitoring and for sequencing of other supplies
- Programmable soft-start provides linear voltage startup
- Bias supply permits low  $V_{IN}$  operation with good transient response
- Stable with any output capacitor  $\geq 2.2\mu F$
- DFN3030-10 and SO-8EP: available in "Green" molding compound (No Br, Sb)
- Lead-free finish/ RoHS Compliant (Note 1)

Note: 1. EU Directive 2002/95/EC (RoHS). All applicable RoHS exemptions applied. Please visit our website at [http://www.diodes.com/products/lead\\_free.html](http://www.diodes.com/products/lead_free.html).

**Pin Assignments**

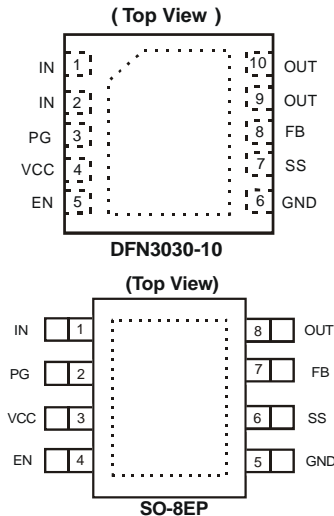

**Applications**

- PCs, Servers, Modems, and Set-Top-Boxes
- FPGA Applications
- DSP Core and I/O Voltages
- Post-Regulation Applications
- Applications With Sequencing Requirements

**Typical Application Circuit**

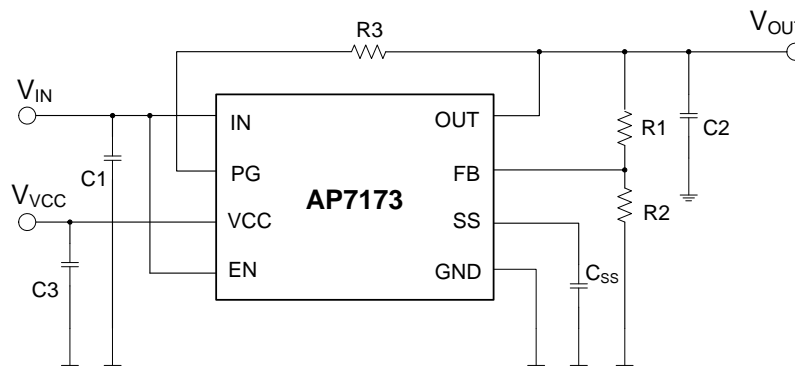

**Figure 1. Typical Application Circuit (Adjustable Output)**

**Typical Application Circuit (Continued)**

**Table 1. Resistor Values for Programming the Output Voltage (Note 2)**

R <sub>1</sub> (kΩ)	R <sub>2</sub> (kΩ)	V <sub>OUT</sub> (V)
Short	Open	0.8
0.619	4.99	0.9
1.13	4.53	1
1.37	4.42	1.05
1.87	4.99	1.1
2.49	4.99	1.2
4.12	4.75	1.5
3.57	2.87	1.8
3.57	1.69	2.5
3.57	1.15	3.3

Note:  $2 V_{OUT} = 0.8 \times (1 + R_1 / R_2)$

**Table 2. Capacitor Values for Programming the Soft-Start Time (Note 3)**

CSS	SOFT-START TIME
Open	0.1ms
270pF	0.5ms
560pF	1ms
2.7nF	5ms
5.6nF	10ms
0.01μF	18ms

Note:  $3. t_{ss}(s) = 0.8 \times C_{ss}(F) / (4.4 \times 10^{-7})$

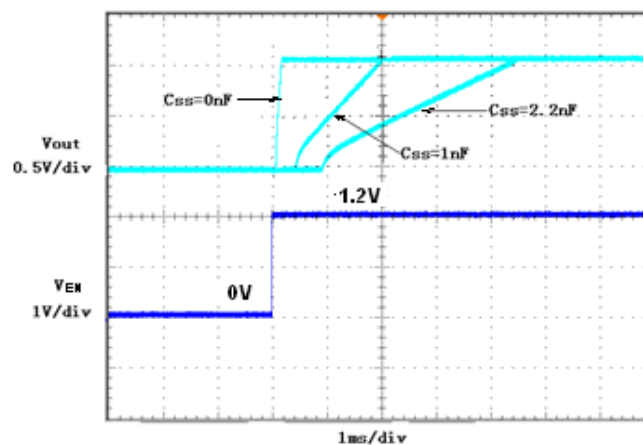
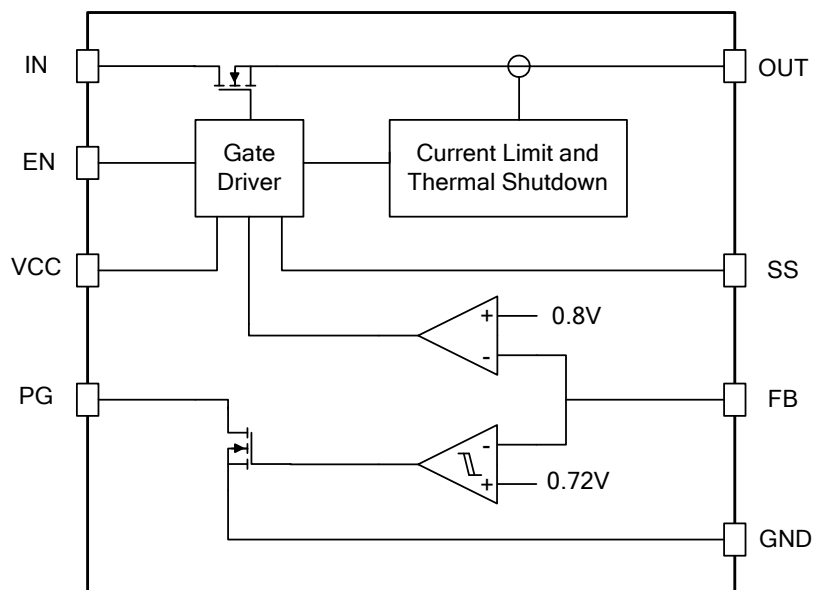

**Figure 2. Turn-On Response**

**Pin Descriptions**

Pin Name	PIN #		Description
	SO-8EP	DFN3030-10	
IN	1	1, 2	Power Input pin.
PG	2	3	Power-Good pin, open-drain output. When the $V_{OUT}$ is below the PG threshold the PG pin is driven low; when the $V_{OUT}$ exceeds the threshold, the PG pin goes into a high-impedance state. To use the PG pin, use a 10k $\Omega$ to 1M $\Omega$ pull-up resistor to pull it up to a supply of up to 5.5V, which can be higher than the input voltage.
VCC	3	4	Bias Input pin, provides input voltage for internal control circuitry. This voltage should be higher than the $V_{IN}$ .
EN	4	5	Enable pin. This pin should be driven either high or low and must not be floating. Driving this pin high enables the regulator, while pulling it low puts the regulator into shutdown mode.
GND	5	6	Ground.
SS	6	7	Soft-Start pin. Connect a capacitor between this pin and the ground to set the soft-start ramp time of the output voltage. If no capacitor is connected, the soft-start time is typically 100 $\mu$ S.
FB	7	8	Feedback pin. Connect this pin to an external voltage divider to set the output voltage.
OUT	8	9, 10	Regulated Output pin.
Thermal Pad	—	—	Solder this pad to large ground plane for increased thermal performance.

**Functional Block Diagram**



### Absolute Maximum Ratings (Note 4)

Symbol	Parameter	Ratings	Unit	
ESD HBM	Human Body Model ESD Protection	4000	V	
ESD MM	Machine Model ESD Protection	350	V	
$V_{IN}, V_{VCC}$	Input Voltage Range	-0.3 to +6	V	
$V_{EN}$	Enable Voltage Range	-0.3 to +6	V	
$V_{PG}$	Power-Good Voltage Range	-0.3 to +6	V	
$V_{SS}$	Soft-Start Voltage Range	-0.3 to +6	V	
$V_{FB}$	Feedback Voltage Range	-0.3 to +6	V	
$V_{OUT}$	Output Voltage Range	-0.3 to $V_{IN} + 0.3$	V	
$I_{OUT}$	Maximum Output Current	Internally Limited		
$P_D$	Continuous Total Power Dissipation (Note 5)	DFN3030-10	3690	mW
		SO-8EP	5650	
$T_J$	Junction Temperature Range	-40 to +150	°C	
$T_{ST}$	Storage Junction Temperature Range	-65 to +150	°C	

- Notes:
- Stresses beyond those listed under Absolute Maximum Ratings may cause permanent damage to the device. These are stress ratings only and functional operation of the device at these conditions is not implied. Exposure to absolute-maximum-rated conditions for extended periods may affect device reliability.
  - Ratings apply to ambient temperature at 25°C. The JEDEC High-K board design used to derive this data was a 2 inch x 2 inch multilayer board with 1-ounce internal power and ground planes and 2-ounce copper traces on the top and bottom of the board.

### Recommended Operating Conditions

Symbol	Parameter	Min	Max	Unit
$V_{IN}$	Input Voltage (Note 6)	1.0	5.5	V
$V_{VCC}$	Bias Voltage	2.7	5.5	V
$I_{OUT}$	Output Current	0	1.5	A
$T_A$	Operating Ambient Temperature	-40	85	°C

- Note: 6. At  $V_{IN} = 1V$ , the maximum load currents may be lower than 1.5A.

## 1.5A LOW DROPOUT LINEAR REGULATOR WITH PROGRAMMABLE SOFT-START

### Electrical Characteristics

At  $V_{EN} = 1.1V$ ,  $V_{IN} = V_{OUT} + 0.5V$ ,  $C_{VCC} = 0.1\mu F$ ,  $C_{IN} = C_{OUT} = 10\mu F$ ,  $I_{OUT} = 50mA$ ,  $V_{VCC} = 5.0V$ , and  $T_A = -40^\circ C$  to  $+85^\circ C$ , unless otherwise noted. Typical values are at  $T_A = +25^\circ C$ .

Symbol	Parameter	Test Conditions	Min	Typ.	Max	Unit	
$V_{IN}$	Input Voltage Range		$V_{OUT} + V_{DO}$		5.5	V	
$V_{VCC}$	Bias Pin Voltage Range (Note 7)		2.7		5.5	V	
$V_{REF}$	Internal Reference (Adj.)	$T_A = +25^\circ C$	0.792	0.8	0.808	V	
$V_{OUT}$	Output Voltage Range	$V_{IN} = 5V$ , $I_{OUT} = 1.5A$	0.8		3.3	V	
	Accuracy (Note 8)	$2.97V \leq V_{VCC} \leq 5.5V$ , $50mA \leq I_{OUT} \leq 1.5A$	-2	$\pm 0.5$	2	%	
$\frac{\Delta V_{OUT}}{\Delta V_{IN}} / \frac{V_{OUT}}{V_{OUT}}$	Line Regulation	$V_{OUT(NOM)} + 0.5 \leq V_{IN}$ , 5.5V		0.03		%/V	
$\frac{\Delta V_{OUT}}{\Delta I_{OUT}} / \frac{V_{OUT}}{\Delta I_{OUT}}$	Load Regulation	$50mA \leq I_{OUT} \leq 1.5A$		0.09		%/A	
$V_{DO}$	Dropout Voltage (Note 9)	$I_{OUT} = 1.5A$ , $V_{VCC} - V_{OUT(NOM)} \geq 3.25V$		165	270	mV	
		$I_{OUT} = 1.5A$ , $V_{IN} = V_{VCC}$		1.5	1.7	V	
$I_{CL}$	Current Limit	$V_{OUT} = 80\% \times V_{OUT(NOM)}$	2	3	4	A	
$I_{SHORT}$	Short-Circuit Current	$V_{OUT} < 0.2V$	0.6	1		A	
$I_{VCC}$	Bias Pin Current			1	2	mA	
$I_{SHDN}$	Shutdown Supply Current ( $I_{GND}$ )	$V_{EN} \leq 0.4V$		1	50	$\mu A$	
$I_{FB}$	Feedback Pin Current		-1	0.1	1	$\mu A$	
PSRR	Power-Supply Rejection ( $V_{IN}$ to $V_{OUT}$ )	1KHZ, $I_{OUT} = 1A$ , $V_{IN} = 1.8V$ , $V_{OUT} = 1.5V$		60		dB	
		300KHZ, $I_{OUT} = 1A$ , $V_{IN} = 1.8V$ , $V_{OUT} = 1.5V$		30			
	Power-Supply Rejection ( $V_{VCC}$ to $V_{OUT}$ )	1KHZ, $I_{OUT} = 1A$ , $V_{IN} = 1.8V$ , $V_{OUT} = 1.5V$			50		dB
		300KHZ, $I_{OUT} = 1A$ , $V_{IN} = 1.8V$ , $V_{OUT} = 1.5V$			30		
$T_{ST}$	Startup Time	$R_{LOAD}$ for $I_{OUT} = 1.0A$ , $C_{SS} = open$		100		$\mu S$	
$I_{SS}$	Soft-Start Charging Current	$V_{SS} = 0.4V$		440		nA	
$V_{EN, HI}$	Enable Input High Level		1.1		5.5	V	
$V_{EN, LO}$	Enable Input Low Level		0		0.4	V	
$V_{EN, HYS}$	Enable Pin Hysteresis			50		mV	
$I_{EN}$	Enable Pin Current	$V_{EN} = 5V$		0.1	1	$\mu A$	
$V_{PG, TH}$	PG Trip Threshold	$V_{OUT}$ decreasing	85	90	94	$\%V_{OUT}$	
$V_{PG, HYS}$	PG Trip Hysteresis			3		$\%V_{OUT}$	
$V_{PG, LO}$	PG Output Low Voltage	$I_{PG} = 1mA$ (sinking), $V_{OUT} < V_{PG, TH}$			0.3	V	
$I_{PG, LKG}$	PG Leakage Current	$V_{PG} = 5.25V$ , $V_{OUT} > V_{PG, TH}$		0.1	1	$\mu A$	
$T_{SD}$	Thermal Shutdown Temperature	Shutdown, temperature increasing		+150		$^\circ C$	
		Reset, temperature decreasing		+130			
$\theta_{JA}$	Thermal Resistance Junction-to-Ambient	DFN3030-10 (Note 10)		35		$^\circ C/W$	
		SO-8EP (Note 11)		23			
$\theta_{JC}$	Thermal Resistance Junction-to-Case	DFN3030-10 (Note 10)		4.9		$^\circ C/W$	
		SO-8EP (Note 11)		1.8			

Notes: 7.  $V_{VCC}$  should be higher or equal to  $V_{IN}$  in this chip.

8. Tested at 0.8V; resistor tolerance is not taken into account.

9. Dropout is defined as the voltage from  $V_{IN}$  to  $V_{OUT}$  when  $V_{OUT}$  is 3% below nominal.

10. Test condition for DFN3030-10: Device mounted on FR-4 substrate (2s2p), 2\*\*2" PCB, with 2oz copper trace thickness and large pad pattern.

11. Test condition for SOP-8L-EP: Device mounted on FR-4 substrate (2s2p), 2\*\*2" PCB, with 2oz copper trace thickness and large pad pattern.

**Typical Characteristics**

At  $T_A = +25^\circ\text{C}$ ,  $V_{IN} = V_{OUT(TYP)} + 0.3\text{V}$ ,  $V_{VCC} = 5\text{V}$ ,  $I_{OUT} = 50\text{mA}$ ,  $V_{EN} = V_{IN}$ ,  $C_{IN} = 1\mu\text{F}$ ,  $C_{VCC} = 4.7\mu\text{F}$ , and  $C_{OUT} = 10\mu\text{F}$ , unless otherwise noted.

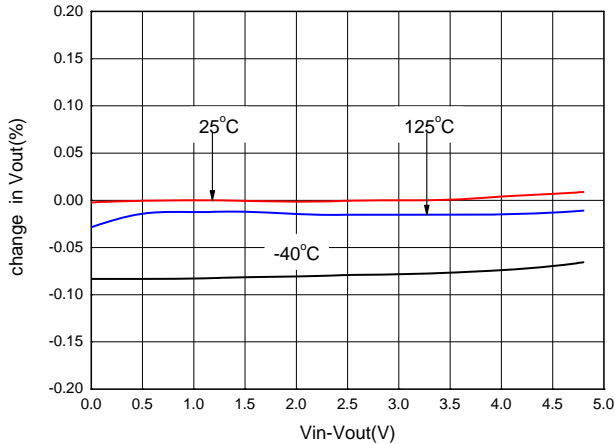

**Figure 3  $V_{IN}$  Line Regulation**

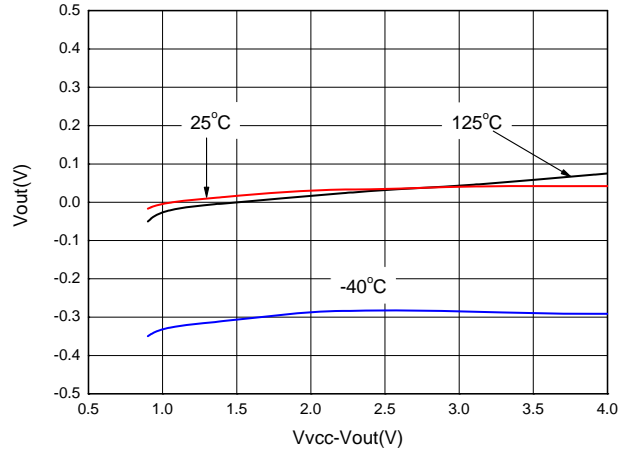

**Figure 4  $V_{VCC}$  Line Regulation**

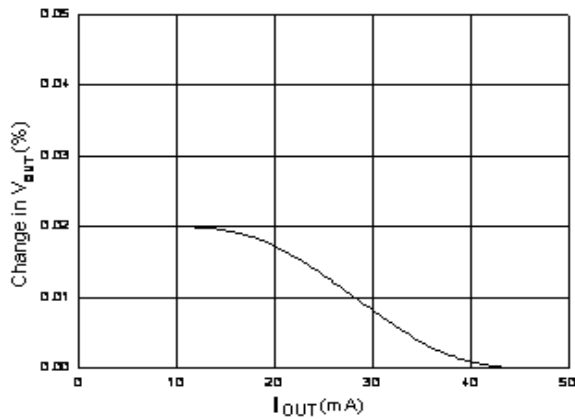

**Figure 5 Load Regulation**

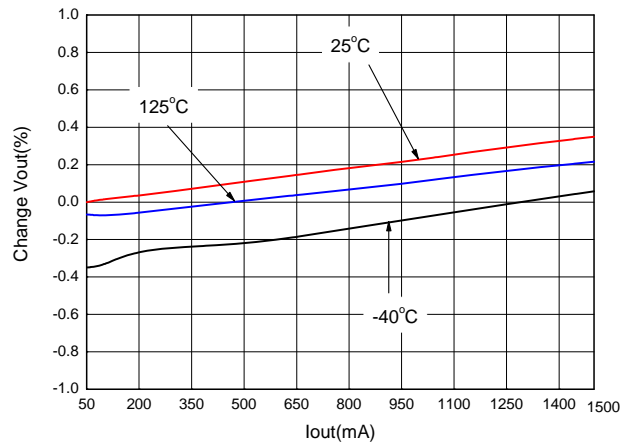

**Figure 6 Load Regulation**

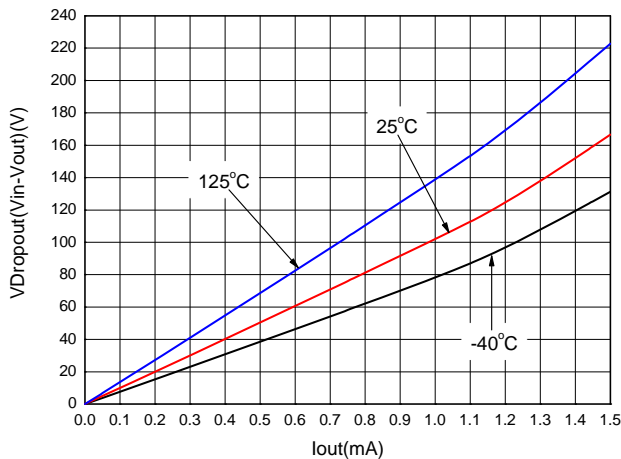

**Figure 7  $V_{IN}$  Dropout Voltage vs.  $I_{OUT}$  and Temperature ( $T_A$ )**

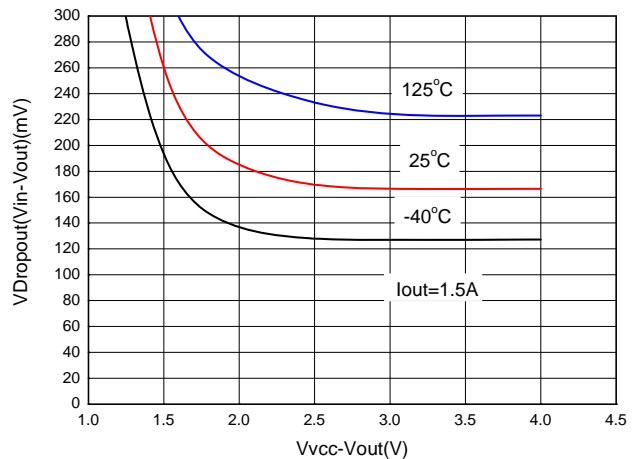

**Figure 8  $V_{IN}$  Dropout Voltage vs. ( $V_{VCC}-V_{OUT}$ ) and Temperature ( $T_A$ )**

**Typical Characteristics (Continued)**

At  $T_A = +25^\circ\text{C}$ ,  $V_{IN} = V_{OUT(TYP)} + 0.3\text{V}$ ,  $V_{VCC} = 5\text{V}$ ,  $I_{OUT} = 50\text{mA}$ ,  $V_{EN} = V_{IN}$ ,  $C_{IN} = 1\mu\text{F}$ ,  $C_{VCC} = 4.7\mu\text{F}$ , and  $C_{OUT} = 10\mu\text{F}$ , unless otherwise noted.

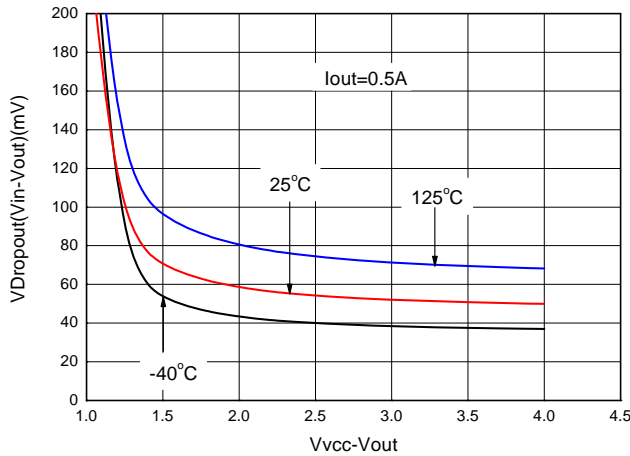

**Figure 9  $V_{IN}$  Dropout Voltage vs.  $(V_{VCC}-V_{OUT})$  and Temperature ( $T_A$ )**

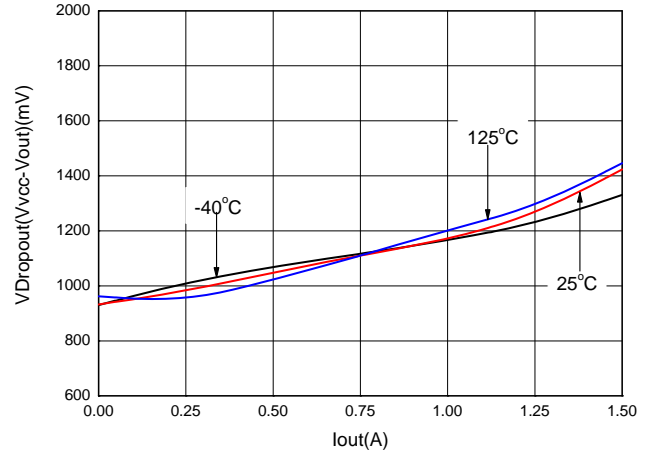

**Figure 10  $V_{VCC}$  Dropout Voltage vs.  $I_{OUT}$  and Temperature ( $T_A$ )**

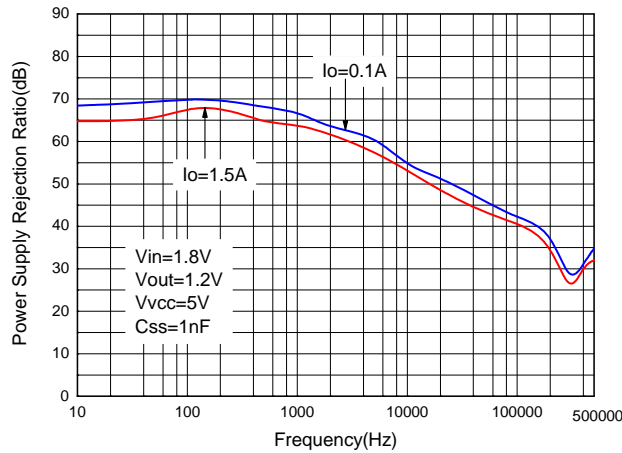

**Figure 11  $V_{IN}$  PSRR vs. Frequency**

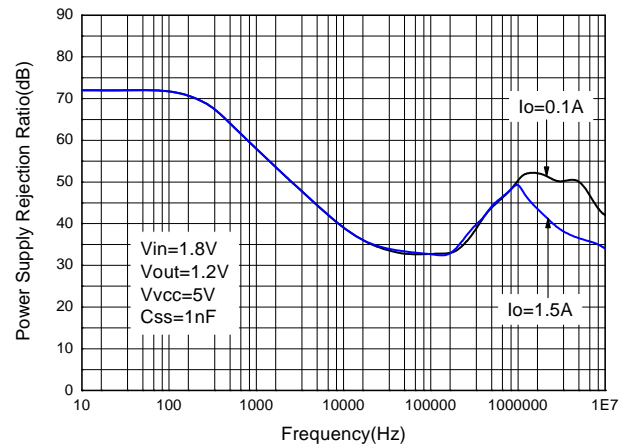

**Figure 12  $V_{VCC}$  PSRR vs. Frequency**

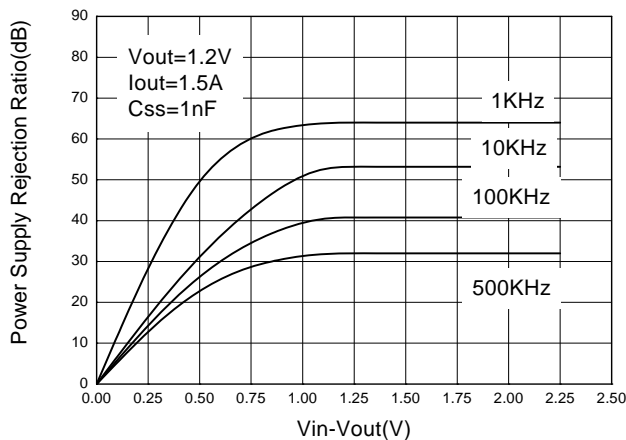

**Figure 13  $V_{IN}$  PSRR vs.  $(V_{IN}-V_{OUT})$**

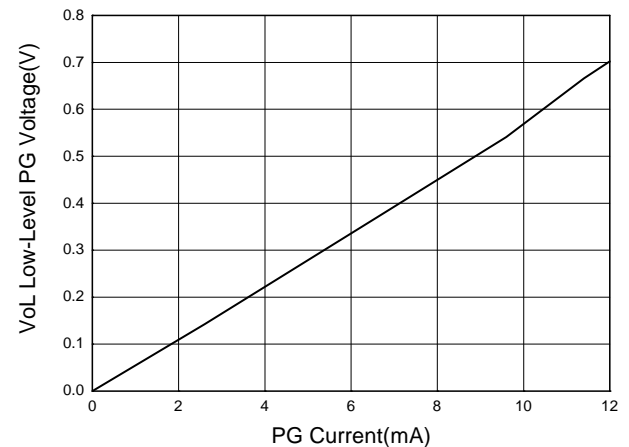

**Figure 14 Low-Level PG Voltage vs Current**

**Typical Characteristics (Continued)**

At  $T_A = +25^\circ\text{C}$ ,  $V_{IN} = V_{OUT(TYP)} + 0.3\text{V}$ ,  $V_{CC} = 5\text{V}$ ,  $I_{OUT} = 50\text{mA}$ ,  $V_{EN} = V_{IN}$ ,  $C_{IN} = 1\mu\text{F}$ ,  $C_{VCC} = 4.7\mu\text{F}$ , and  $C_{OUT} = 10\mu\text{F}$ , unless otherwise noted.

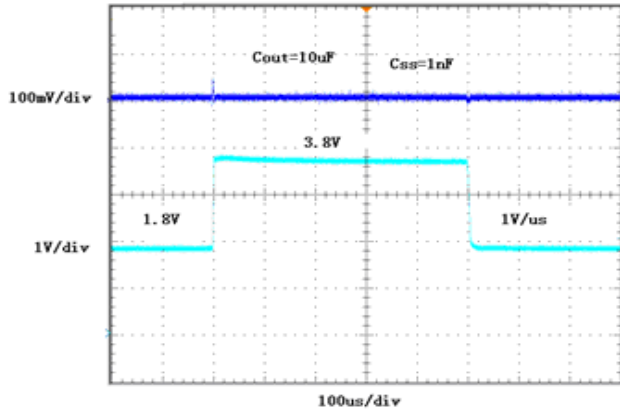

**Figure 15  $V_{IN}$  Line Transient**

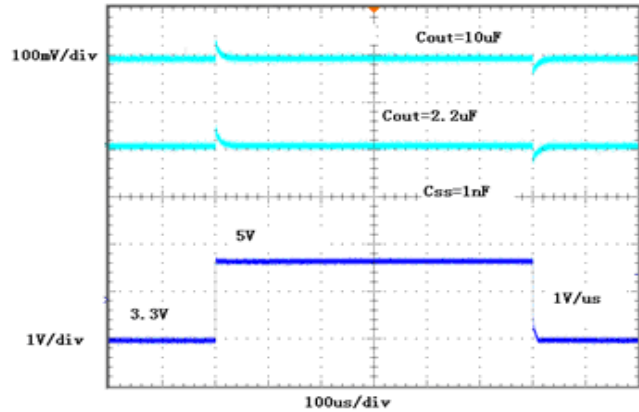

**Figure 16  $V_{CC}$  Line Transient**

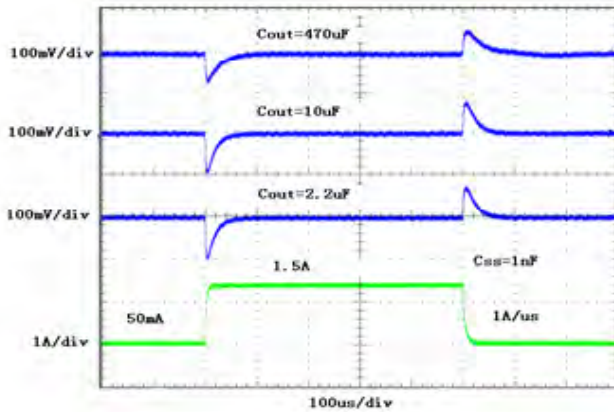

**Figure 17 Output Load Transient**

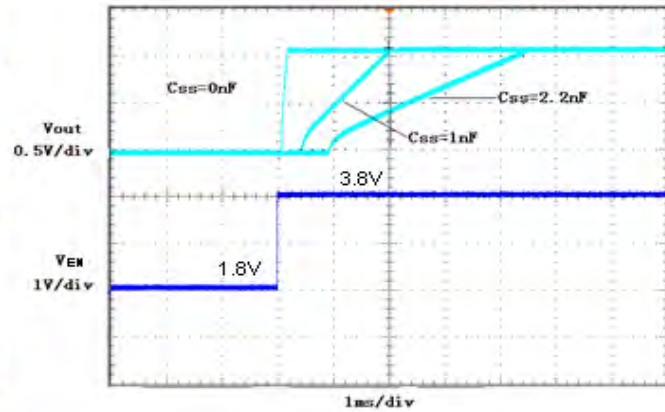

**Figure 18 Turn-On Response**

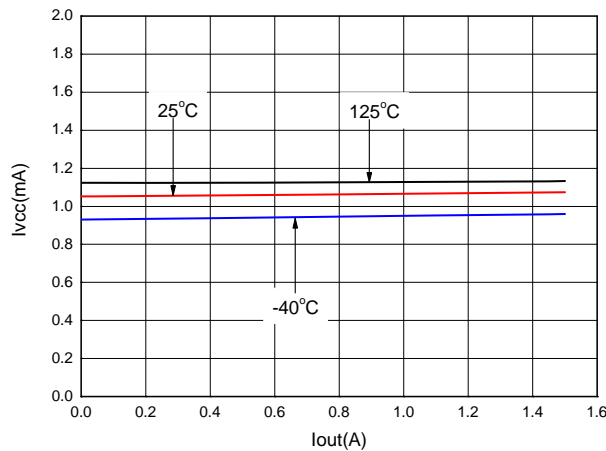

**Figure 19  $V_{CC}$  Pin Current vs.  $I_{OUT}$  and Temperature**

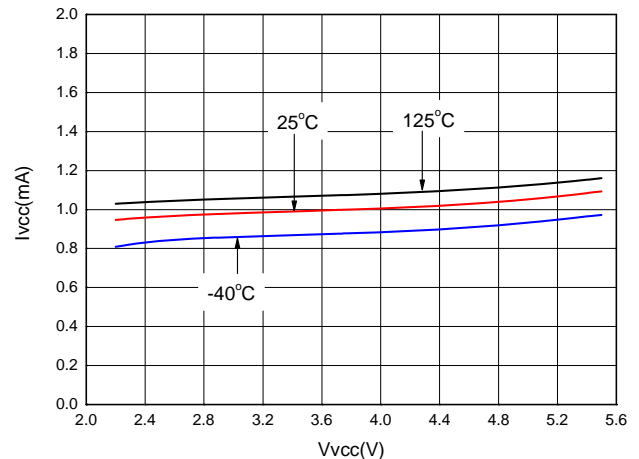
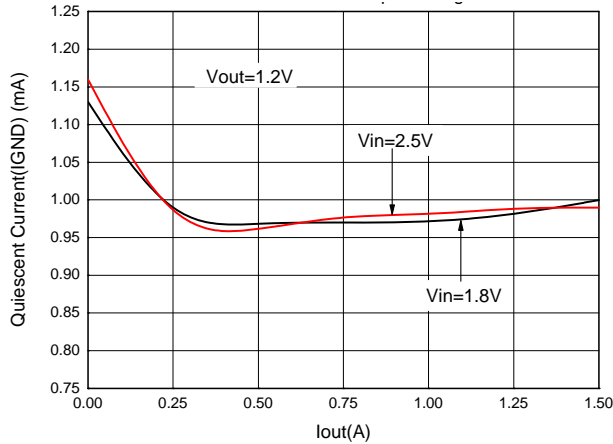

**Figure 20  $V_{CC}$  Pin Current vs.  $V_{CC}$  and Temperature**



**Typical Characteristics (Continued)**

At  $T_A = +25^\circ\text{C}$ ,  $V_{IN} = V_{OUT(TYP)} + 0.3\text{V}$ ,  $V_{VCC} = 5\text{V}$ ,  $I_{OUT} = 50\text{mA}$ ,  $V_{EN} = V_{IN}$ ,  $C_{IN} = 1\mu\text{F}$ ,  $C_{VCC} = 4.7\mu\text{F}$ , and  $C_{OUT} = 10\mu\text{F}$ , unless otherwise noted.



**Figure 21 Quiescent Current vs.  $I_{OUT}$**

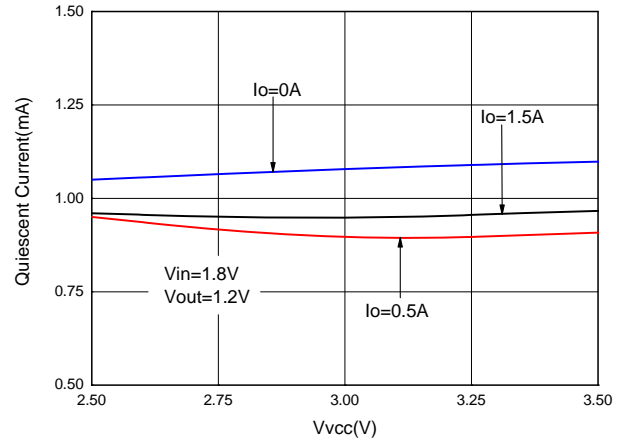

**Figure 22. Quiescent Current vs.  $V_{VCC}$**

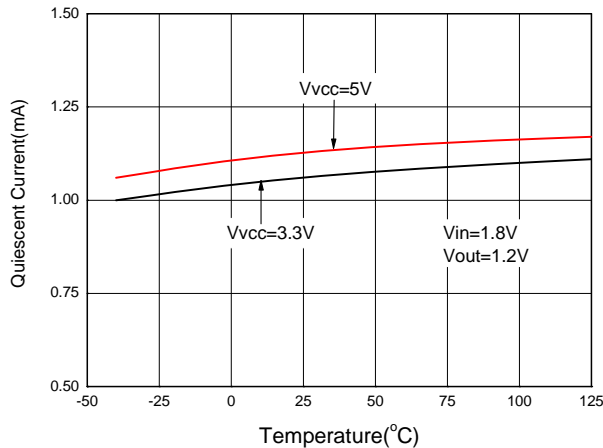

**Figure 23 Quiescent Current vs. Temperature**

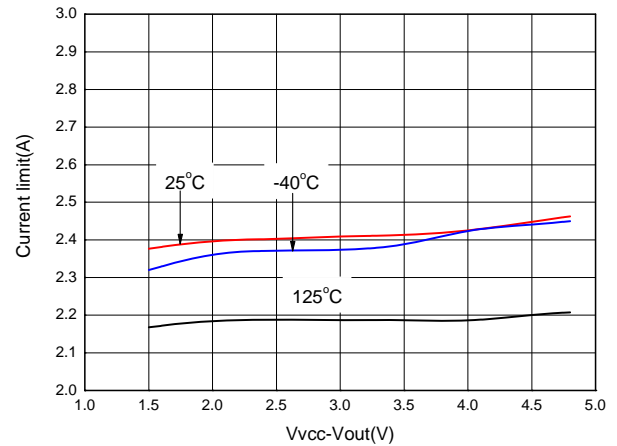

**Figure 24 Current Limit vs.  $(V_{VCC}-V_{OUT})$**

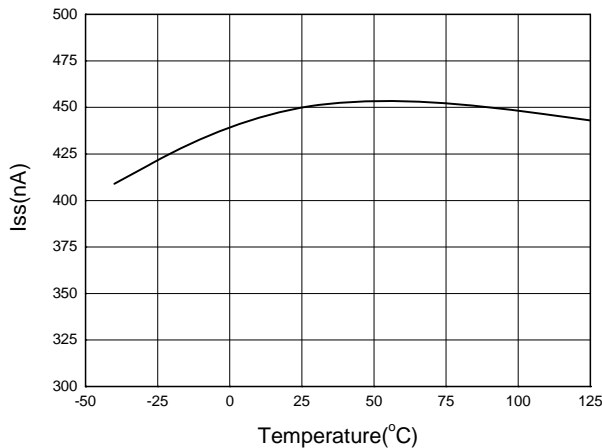

**Figure 25 Soft-Start Charging Current ( $I_{SS}$ ) vs. Temperature**

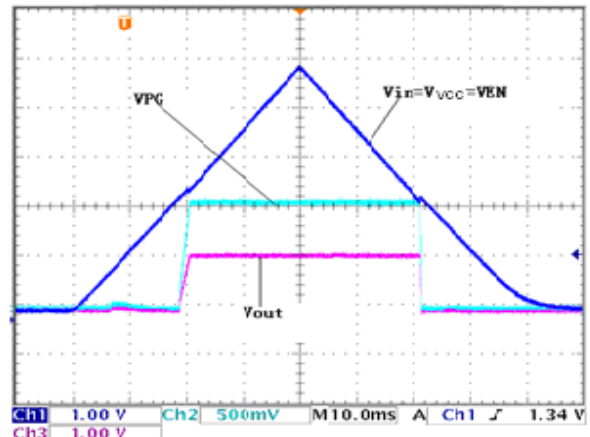
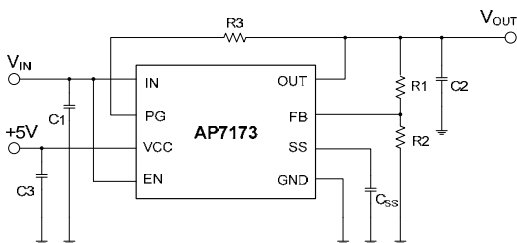

**Figure 26 Power-Up/Power-Down**

**Application Notes**

**BIAS VOLTAGE  $V_{VCC}$**

The AP7173 is a low  $V_{IN}$ , low dropout regulator that uses an NMOS pass FET. The VCC pin must be connected to a DC bias supply  $V_{VCC}$  for the internal control circuitry and the gate drive of the pass FET to function properly and to obtain low dropout. The  $V_{VCC}$  needs to be equal to or higher than the  $V_{IN}$  and in the range of 2.7V-5.5V. Figure 27 illustrates the typical application circuit for the AP7173.



**Figure 27. Typical Application Circuit for AP7173**

**ADJUSTABLE OUTPUT VOLTAGE**

With an external voltage divider, the AP7173 can provide output voltage from 0.8V to 3.3V. R1 and R2 can be calculated for any output voltage using the following equation, where  $V_{REF}=0.8$  is the AP7173's internal reference voltage. Refer to Table 1 for resistor combinations for commonly used output voltages. For maximum voltage accuracy, R2 should be  $\leq 5k\Omega$ .

$$V_{OUT} = V_{REF} \times (1 + R1/R2)$$

**INPUT  $V_{IN}$  AND BIAS  $V_{VCC}$  CAPACITORS**

It is important to keep the IN and VCC pins clear of large ripples, glitches and other noises by connecting capacitors to the IN and VCC pins. The required capacitance on these pins is strongly dependent on source and wiring impedance of the supplies.

To provide good decoupling for the input power supply  $V_{IN}$ , it is recommended that a ceramic capacitor with capacitance of at least  $1\mu F$  is connected between the IN and GND pins at a location as close to them as possible. High quality, low ESR capacitors should be used for better performance.

It is critical to provide good decoupling to the VCC pin for the AP7173's internal control circuitry to function properly. The minimum recommended capacitance for the  $V_{VCC}$  is  $1\mu F$  when the  $V_{VCC}$  and  $V_{IN}$  are separate supplies. If the  $V_{IN}$  and  $V_{VCC}$  are connected to the same supply, the recommended minimum capacitance for  $V_{VCC}$  is  $4.7\mu F$ . Again good quality, low ESR capacitors should be used for optimum performance.

**OUTPUT CAPACITOR**

The output capacitor affects the stability and transient response of the LDO. The AP7173 is designed to be stable for all types of output capacitors  $\geq 2.2\mu F$ , single or multiple in parallel.

Using high quality, low ESR capacitors and placing them close to the OUT and GND pins can improve performance.

**DROPOUT VOLTAGE**

The very low dropout makes the AP7173 well suited for high-current, low  $V_{IN}$ /low  $V_{OUT}$  applications. To achieve the specified low-dropout performance for such applications, the VCC pin should be connected to a separate supply of at least 3.25V higher than  $V_{OUT}$ . Figure 28 shows an application circuit where  $V_{VCC}$  is 5V and  $V_{OUT}$  is 1.2V.

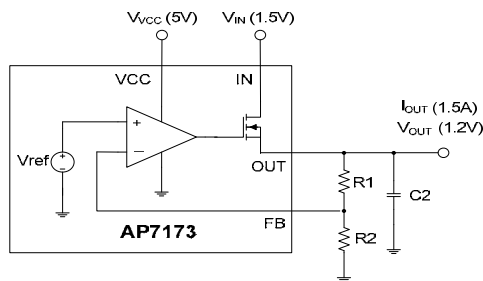

**Figure. 28 Typical Application Circuit for AP7173 Using Separate VCC and IN Rails**

For applications where low dropout is not required or a separate  $V_{VCC}$  supply is not available, the IN and VCC pins can be tied together. In this situation, a voltage difference of at least 1.7V between the  $V_{VCC}$  and  $V_{OUT}$  has to be maintained for the  $V_{VCC}$  to provide enough gate drive to the pass FET. Therefore, the  $V_{OUT}$  needs to be 1.7V or more below  $V_{IN}$ , as shown in Figure 29.

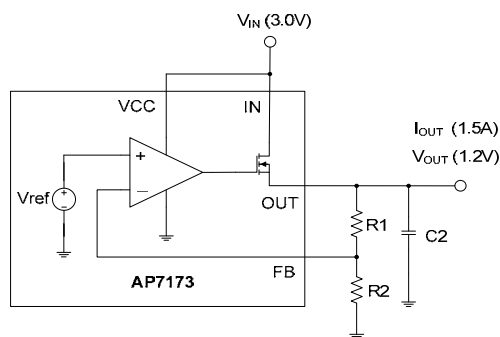

**Figure. 29 Typical Application Circuit for AP7173 Without an Auxiliary VCC Rail**

**PROGRAMMABLE SOFT-START**

The AP7173 features a voltage-controlled soft-start that is programmable with an external capacitor ( $C_{SS}$ ). The AP7173 achieves a monotonic soft-start by tracking the voltage ramp of the external soft-start capacitor until the ramp voltage reaches the internal reference voltage.

**Application Notes (Continued)**

**PROGRAMMABLE SOFT-START (cont.)**

The relationship between the soft-start time and the soft-start charging current ( $I_{SS}$ ), soft-start capacitance ( $C_{SS}$ ), and the internal reference voltage ( $V_{REF}$ ) is

$$t_{SS} = (V_{REF} \times C_{SS}) / I_{SS}$$

Refer to Table 2 for suggested soft-start capacitor values

**ENABLE/SHUTDOWN**

The EN pin can be used with standard digital signals or relatively slow-ramping analog signals. Pulling the  $V_{EN}$  below 0.4V turns the regulator off, while driving the  $V_{EN}$  above 1.1V turns the regulator on. Figure 30 shows an example where an RC circuit is used to delay start the AP7173.

If not used, the EN pin can be connected to the VCC or IN pin when the  $V_{IN}$  is greater than 1.1V, as long as good decoupling measures are taken for the EN pin.

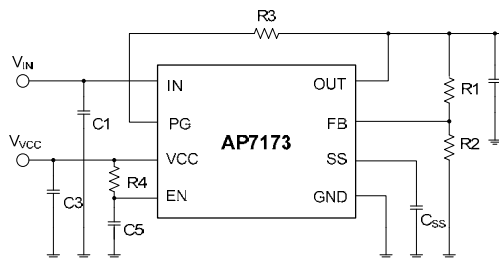

**Figure 30. Delayed Start Using an RC Circuit to Enable AP7173**

**POWER-GOOD**

The power-good (PG) pin is an open-drain output and can be pulled up through a resistor of 10kΩ to 1MΩ to  $V_{IN}$ ,  $V_{OUT}$  or any other rail that is 5.5V or lower. When the  $V_{OUT} \geq V_{PG,TH} + V_{PG,HYS}$ , the PG output is high-impedance; if the  $V_{OUT}$  drops to below  $V_{PG,TH}$ ,  $V_{VCC} \leq 1.9V$  or the device is disabled, the PG pin is pulled to low by an internal MOSFET.

**OVER-CURRENT AND SHORT-CIRCUIT PROTECTION**

The AP7173 features a factory-trimmed, temperature and supply voltage compensated internal current limit and an

over-current protection circuitry to protect the device against overload conditions. It limits the device current to a typical value of 3A and reduces the  $V_{OUT}$  when the load tries to pull more current.

For more effective protection against short-circuit failure, the AP7173 also includes a short-circuit foldback mechanism that lowers the current limit to a typical value of 1.0A when the  $V_{FB}$  drops to below 0.2V.

**THERMAL PROTECTION**

Thermal shutdown limits the AP7173 junction temperature and protects the device from damage as a result of overheating.

Thermal protection turns off the  $V_{OUT}$  when the AP7173's junction temperature rises to approximately +150°C, allowing it to cool down. When the junction temperature drops to approximately +130°C, the output is re-enabled. Therefore, the thermal protection circuit may cycle on and off at a rate dependent on the power dissipation, thermal resistance, and ambient temperature.

**POWER DISSIPATION**

Thermal shutdown is intended to protect the AP7173 against abnormal overheating. For normal operation, excessive power dissipation should be avoided and good heatsinking should be provided. Power dissipation in the device is the product of the device dropout voltage and the load current,

$$P_D = (V_{IN} - V_{OUT}) \times I_{OUT}$$

As can be seen, power dissipation can be minimized by using the lowest input voltage necessary to achieve the required output voltage regulation.

To ensure that the device junction temperature does not exceed the specified limit of 125°C, an application should provide heat conduction paths that have junction-to-ambient thermal resistance lower than the calculated value here:

$$R_{\theta JA} = (125^\circ\text{C} - T_A) / P_D$$

For the DFN package with exposed pad, the primary conduction path for heat is through the exposed pad to the printed circuit board (PCB). The pad should be attached to an appropriate amount of copper PCB area to ensure that the device does not overheat.

**Ordering Information**

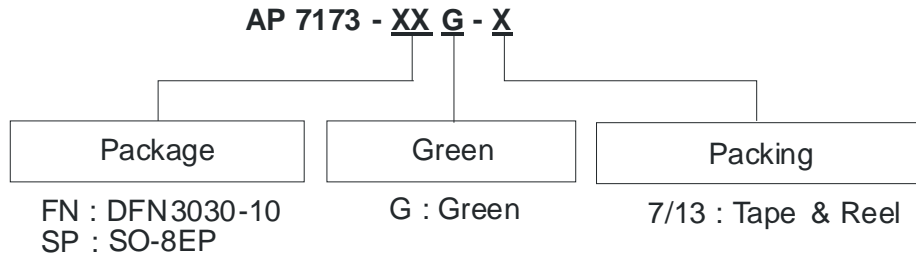

Device	Package Code	Packaging (Note 12)	7"/13" Tape and Reel	
			Quantity	Part Number Suffix
AP7173-FNG-7	FN	DFN3030-10	3000/Tape & Reel	-7
AP7173-SPG-13	SP	SO-8EP	2500/Tape & Reel	-13

Note: 12. Pad layout as shown on Diodes Inc. suggested pad layout document AP02001, which can be found on our website at <http://www.diodes.com/datasheets/ap02001.pdf>.

**Marking Information**

**(1) DFN3030-10**

**( Top View )**

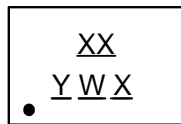

XX : Identification Code  
Y : Year : 0~9  
W : Week : A~Z : 1~26 week;  
           a~z : 27~52 week; z represents  
           52 and 53 week  
X : A~Z : Green

Part Number	Package	Identification Code
AP7173	DFN3030-10	BA

**(2) SO-8EP**

**( Top View )**

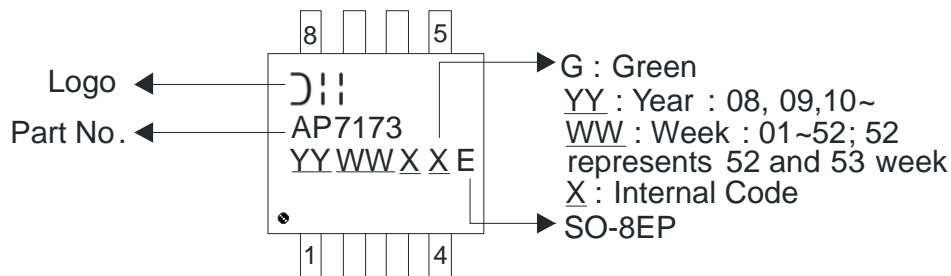

**Package Outline Dimensions (All Dimensions in mm)**

**(1) Package Type: DFN3030-10**

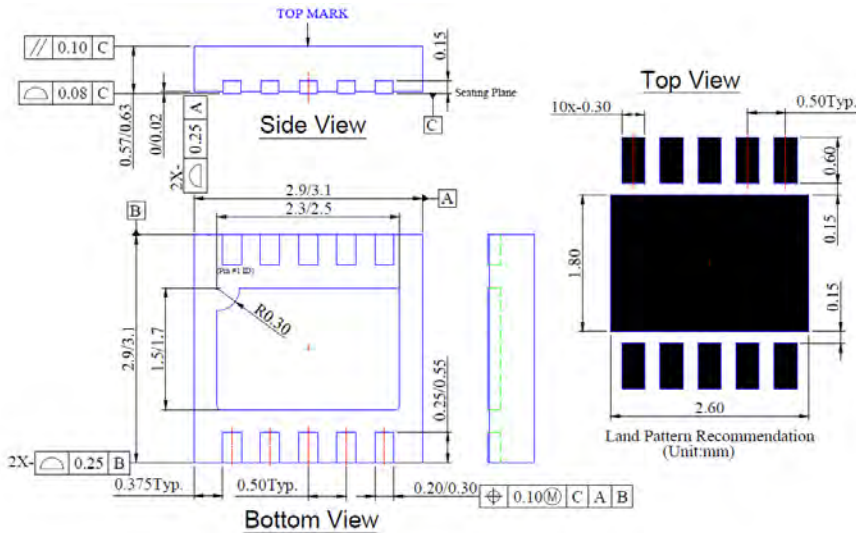

**(2) Package Type: SO-8EP**

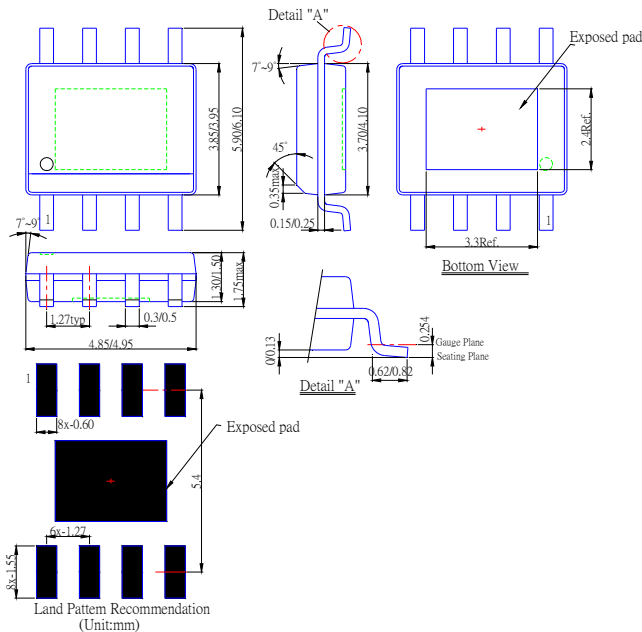

---

**Tape Orientation**

---

For DFN3030-10

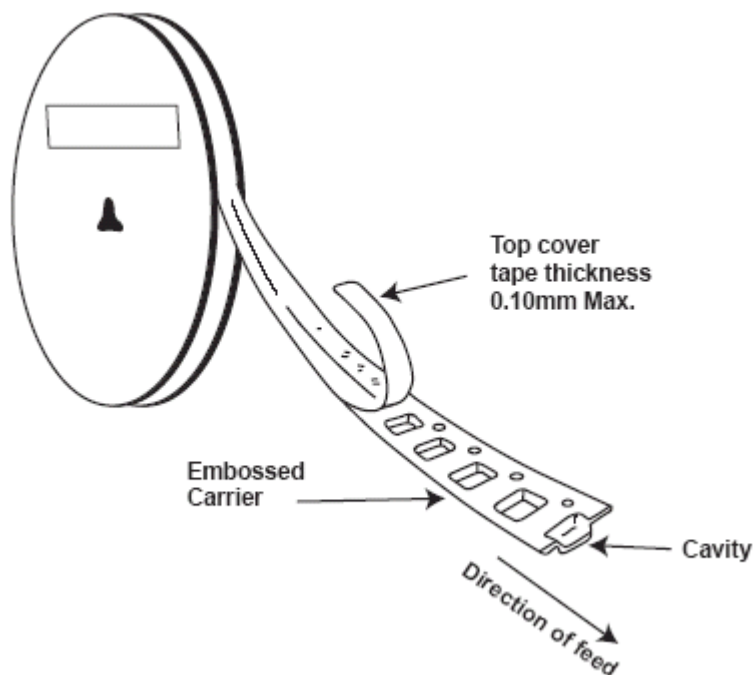
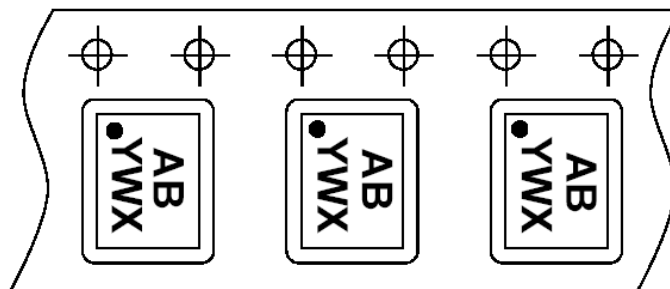

Notes: 13. The taping orientation of the other package type can be found on our website at <http://www.diodes.com/datasheets/ap02007.pdf>

**IMPORTANT NOTICE**

DIODES INCORPORATED MAKES NO WARRANTY OF ANY KIND, EXPRESS OR IMPLIED, WITH REGARDS TO THIS DOCUMENT, INCLUDING, BUT NOT LIMITED TO, THE IMPLIED WARRANTIES OF MERCHANTABILITY AND FITNESS FOR A PARTICULAR PURPOSE (AND THEIR EQUIVALENTS UNDER THE LAWS OF ANY JURISDICTION).

Diodes Incorporated and its subsidiaries reserve the right to make modifications, enhancements, improvements, corrections or other changes without further notice to this document and any product described herein. Diodes Incorporated does not assume any liability arising out of the application or use of this document or any product described herein; neither does Diodes Incorporated convey any license under its patent or trademark rights, nor the rights of others. Any Customer or user of this document or products described herein in such applications shall assume all risks of such use and will agree to hold Diodes Incorporated and all the companies whose products are represented on Diodes Incorporated website, harmless against all damages.

Diodes Incorporated does not warrant or accept any liability whatsoever in respect of any products purchased through unauthorized sales channel.

Should Customers purchase or use Diodes Incorporated products for any unintended or unauthorized application, Customers shall indemnify and hold Diodes Incorporated and its representatives harmless against all claims, damages, expenses, and attorney fees arising out of, directly or indirectly, any claim of personal injury or death associated with such unintended or unauthorized application.

Products described herein may be covered by one or more United States, international or foreign patents pending. Product names and markings noted herein may also be covered by one or more United States, international or foreign trademarks.

**LIFE SUPPORT**

Diodes Incorporated products are specifically not authorized for use as critical components in life support devices or systems without the express written approval of the Chief Executive Officer of Diodes Incorporated. As used herein:

- A. Life support devices or systems are devices or systems which:
1. are intended to implant into the body, or
  2. support or sustain life and whose failure to perform when properly used in accordance with instructions for use provided in the labeling can be reasonably expected to result in significant injury to the user.
- B. A critical component is any component in a life support device or system whose failure to perform can be reasonably expected to cause the failure of the life support device or to affect its safety or effectiveness.

Customers represent that they have all necessary expertise in the safety and regulatory ramifications of their life support devices or systems, and acknowledge and agree that they are solely responsible for all legal, regulatory and safety-related requirements concerning their products and any use of Diodes Incorporated products in such safety-critical, life support devices or systems, notwithstanding any devices- or systems-related information or support that may be provided by Diodes Incorporated. Further, Customers must fully indemnify Diodes Incorporated and its representatives against any damages arising out of the use of Diodes Incorporated products in such safety-critical, life support devices or systems.

Copyright © 2011, Diodes Incorporated

[www.diodes.com](http://www.diodes.com)

单击下面可查看定价，库存，交付和生命周期等信息

[>>Diodes Incorporated\(达尔科技\)](#)