

Typical Applications Circuit

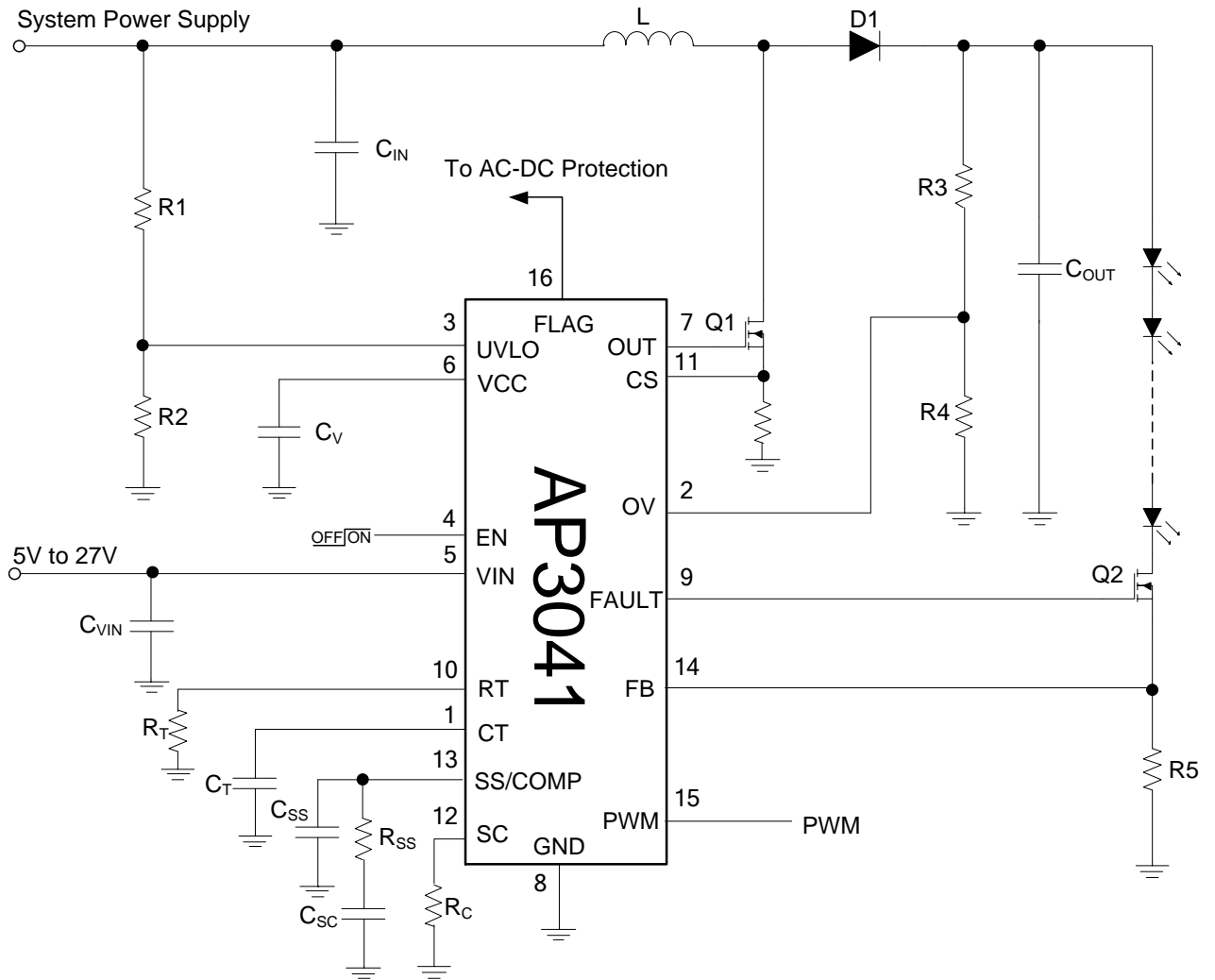

Pin Descriptions

Pin Number	Pin Name	Function
1	CT	Capacitor Setting Shut Down Delay Time
2	OV	Over Output Voltage Protection Pin
3	UVLO	Two resistors connected from this pin to GND and the power supply respectively is used to set start-up and shutdown level.
4	EN	Enable Pin
5	VIN	Input supply pin. This pin must be locally bypassed.
6	VCC	This pin should be bypassed to GND with a ceramic capacitor.
7	OUT	Connect this pin to the gate of external MOSFET, the gate driver has 1A peak current capability.
8	GND	Ground
9	FAULT	This pin can be used to drive the external MOSFET. The logic of the driver signal is controlled by that of PWM pin and the signal phase of them is the same. This pin is pulled to ground under fault condition of OVP, UVLO, OTP, diode short circuit and LED short circuit.
10	RT	An external resistor connected from this pin to GND is used to set the operating frequency.
11	CS	Sense switch current pin, which is used for current mode control and for current limit. The current limit voltage is 500mV.
12	SC	Slope compensation for current sense. A resistor between SC and GND will program the slope compensation.
13	SS/COMP	An external soft-start time capacitor is placed from this pin to GND and is charged by an internal 20 μ A current source to control regulator soft-start time. Compensation pin. This pin is the output of the internal error amplifier.
14	FB	Voltage feedback pin. The reference voltage is 500mV.
15	PWM	This pin can be connected to current matched chip and receives error signal used to shut down the system.
16	FLAG	Fault condition output pin. When the output is in short circuit condition, the FLAG outputs logic low to shut down the power path. Please refer to the application circuit.

Functional Block Diagram

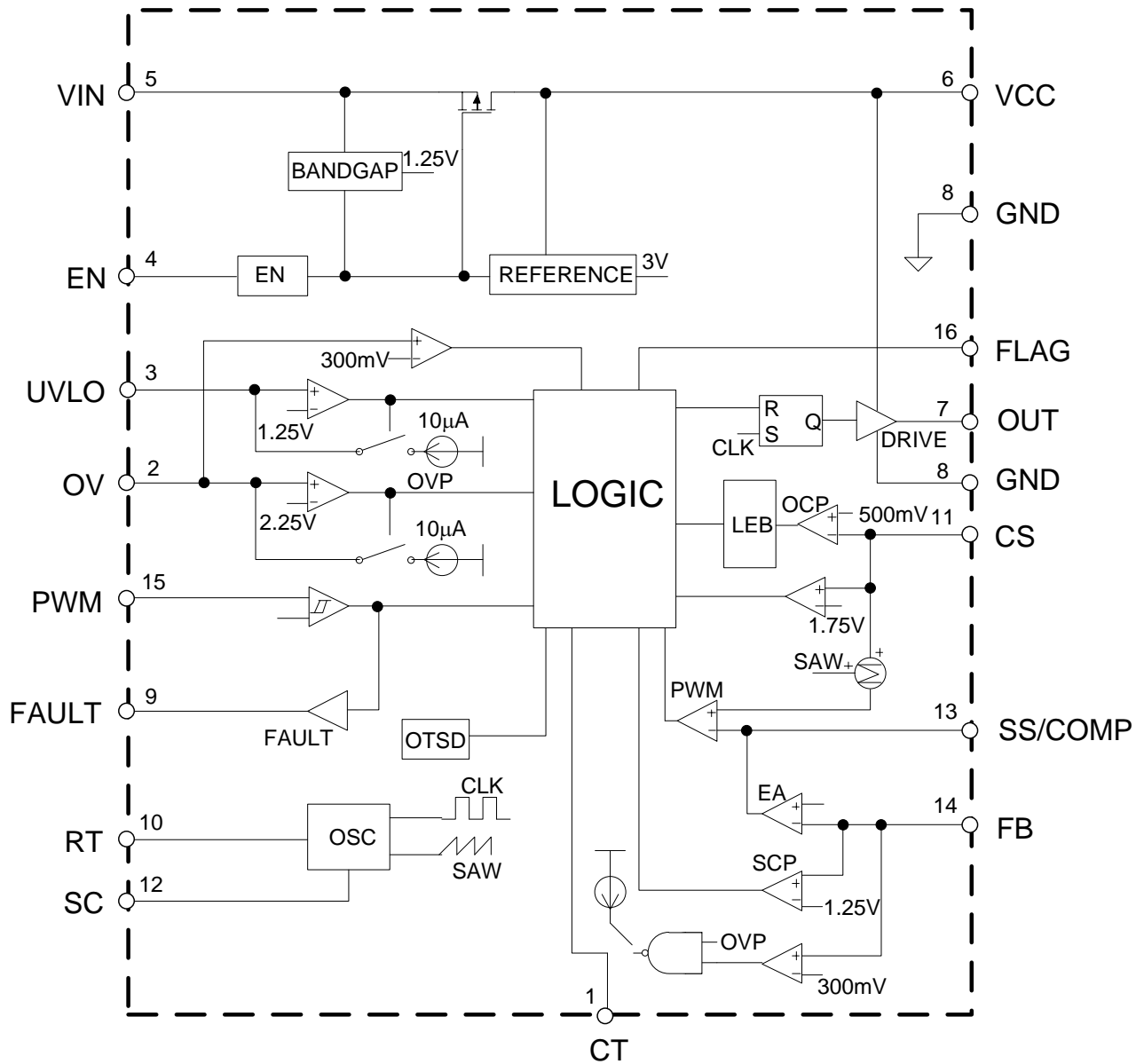

Absolute Maximum Ratings (Note 4)

Symbol	Parameter	Value	Unit
V_{IN}	Input Voltage	30	V
V_{CC}	VCC Pin Voltage	20	V
V_{OUT}	OUT Pin Voltage	20	V
V_{FAULT}	FAULT Pin Voltage	20	V
V_{FB}	FB Pin Voltage	20	V
V_{UVLO}	UVLO Pin Voltage	7	V
V_{CS}	CS Pin Voltage	20	V
V_{SC}	SC Pin Voltage	7	V
V_{FLAG}	FLAG Pin Voltage	7	V
$V_{SS/COMP}$	SS/COMP Pin Voltage	7	V
V_{RT}	RT Pin Voltage	7	V
V_{PWM}	PWM Pin Voltage	7	V
V_{EN}	EN Pin Voltage	30	V
V_{OV}	OV Pin Voltage	7	V
θ_{JA}	Thermal Resistance (Junction to Ambient, No Heat Sink, Free Air)	82	°C/W
T_J	Operating Junction Temperature	+150	°C
T_{STG}	Storage Temperature	-65 to +150	°C
T_{LEAD}	Lead Temperature (Soldering, 10s)	+260	°C
—	ESD (Human Body Model)	2000	V
—	ESD (Machine Model)	200	V

Note: 4. Stresses greater than those listed under *Absolute Maximum Ratings* can cause permanent damage to the device. These are stress ratings only, and functional operation of the device at these or any other conditions beyond those indicated under *Recommended Operating Conditions* is not implied. Exposure to *Absolute Maximum Ratings* for extended periods can affect device reliability.

Recommended Operating Conditions

Symbol	Parameter	Min	Max	Unit
V_{IN}	Input Voltage	5	27	V
f	Operating Frequency	0.1	1	MHz
T_J	Operating Temperature Range	-40	+85	°C

Electrical Characteristics ($V_{CC}=12V$, $V_{EN}=3.3V$, $T_A=+25^{\circ}C$, unless otherwise specified.)

Symbol	Parameter	Conditions	Min	Typ	Max	Unit
V_{IN}	Input Voltage	—	5	—	27	V
V_{FB}	Feedback Voltage	—	490	500	510	mV
I_{CC}	Supply Current	$V_{FB}=V_{IN}$, No Switching	—	1.5	5	mA
I_Q	Shutdown Supply Current	$V_{EN}=0$	—	1	2	μA
V_{CC}	VCC Pin Voltage	$11V \leq V_{IN} \leq 27V$	9.5	10.0	10.5	V
		$5V \leq V_{IN} \leq 10V$, $I_{CC}=5mA$	$V_{IN}-0.5$	—	—	V
I_{CC-LIM}	VCC Pin Current Limit	—	—	35	—	mA
V_{CC-HI}	VCC Pin UVLO Rising Threshold	—	—	4.7	—	V
V_{CC-HYS}	VCC Pin UVLO Falling Hysteresis	—	—	300	—	mV
f_{OSC}	Oscillator Frequency	—	0.1	—	1	MHz
V_{SC_PK}	SC Peak Voltage	—	530	—	680	mV
V_{UVLO}	UVLO Threshold	—	1.20	1.25	1.30	V
$I_{UVLO-HYS}$	UVLO Hysteresis Current Source	—	—	10	—	μA
V_{CS}	Current Limit Threshold Voltage	—	0.48	0.5	0.52	V
V_{RT}	RT Voltage	—	1.20	1.25	1.30	V
G_V	Error Amplifier Voltage Gain	—	—	680	—	V/V
G_S	Error Amplifier Transconductance	—	—	500	—	$\mu A/V$
V_{EH}	EN Pin Threshold Voltage	—	2.5	—	—	V
V_{EL}		—	—	—	0.5	
V_{IH}	PWM Pin Threshold Voltage	—	2.5	—	—	V
V_{IL}		—	—	—	0.5	
V_{OV}	OV Threshold	—	—	2.25	—	V
I_{OV-HYS}	OV Hysteresis Current Source	—	—	10	—	μA
V_{FB_LOW}	LED- Short to GND Detection Level	—	—	0.3	—	V
V_{FB_HIGH}	LED+ Short to LED-Detection Level	—	—	1.25	—	V
V_{OV_LOW}	LED+ Short to GND Detection Level	—	—	0.3	—	V
V_{CS_HIGH}	Diode Short Detection Level	—	—	1.75	—	V
I_{CT}	CT Current Source	—	—	5	—	μA
V_{CT}	CT Threshold Voltage	—	—	2.6	—	V

Electrical Characteristics (continued, $V_{CC}=12V$, $V_{EN}=3.3V$, $T_A=+25^{\circ}C$, unless otherwise specified.)

Symbol	Parameter	Conditions	Min	Typ	Max	Unit
D_{MAX}	Maximum Duty Cycle	$f=200kHz$	80	90	—	%
I_{SS}	Soft-Start Current Source	—	16	22	28	μA
t_{RISE}	OUT Pin Rising Time	$C_{OUT}=1nF$	—	20	—	ns
t_{FALL}	OUT Pin Falling Time	$C_{OUT}=1nF$	—	20	—	
V_{OUT-H}	OUT High Voltage Level ($V_{CC}-V_{OUT}$)	$I_{OUT}=50mA$	—	0.25	0.75	V
V_{OUT-L}	OUT Low Voltage Level (V_{OUT})	$I_{OUT}=50mA$	—	0.25	0.75	V
t_{RISE}	FAULT Pin Rising Time	$C_{FAULT}=1nF$	—	100	—	ns
t_{FALL}	FAULT Pin Falling Time	$C_{FAULT}=1nF$	—	100	—	
$V_{FAULT-H}$	FAULT High Voltage Level ($V_{CC}-V_{FAULT}$)	$I_{FAULT}=10mA$	—	0.25	0.75	V
$V_{FAULT-L}$	FAULT Low Voltage Level	$I_{FAULT}=10mA$	—	0.25	0.75	V
t_D	FAULT Minimum Pulse Width	Oscillator Frequency=200kHz	—	20	—	μs
V_{FLAG-H}	FLAG High Voltage Level	$I_{FLAG}=500\mu A$	—	2	—	V
V_{FLAG-L}	FLAG Low Voltage Level	$I_{FLAG}=500\mu A$	—	0.25	0.75	V
T_{OTSD}	Thermal Shutdown Temperature	—	—	+160	—	$^{\circ}C$
T_{HYS}	Thermal Shutdown Hysteresis	—	—	+20	—	$^{\circ}C$

Performance Characteristics

LED Current vs. PWM Duty

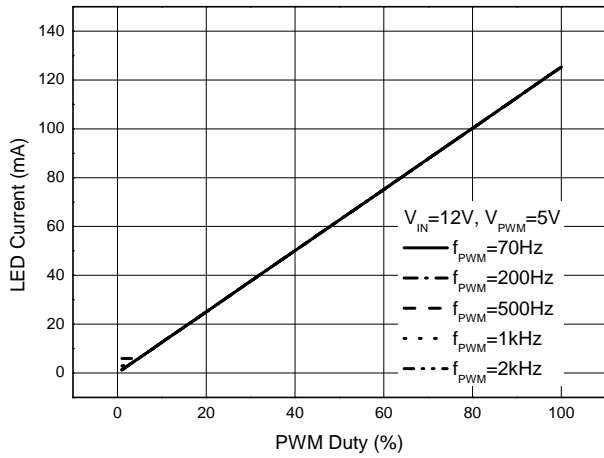

Frequency vs. R_T

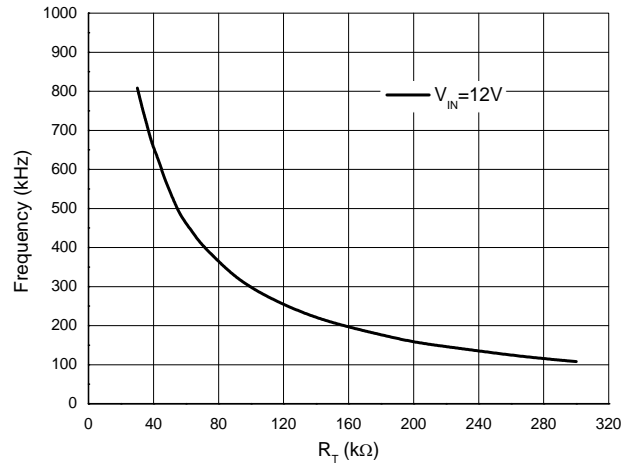

V_{FB} vs. Temperature

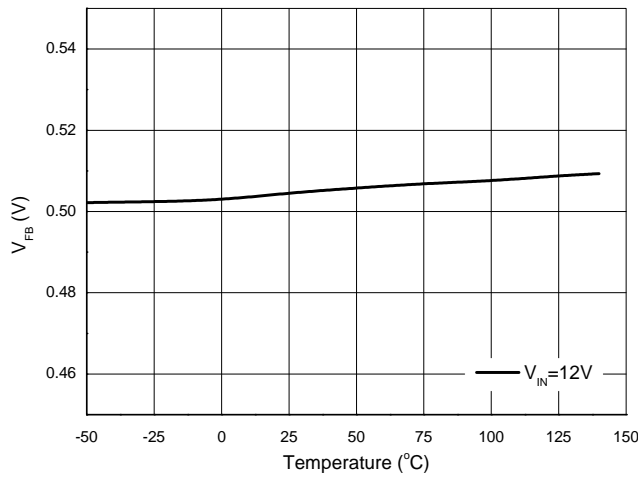

Supply Current vs. Temperature

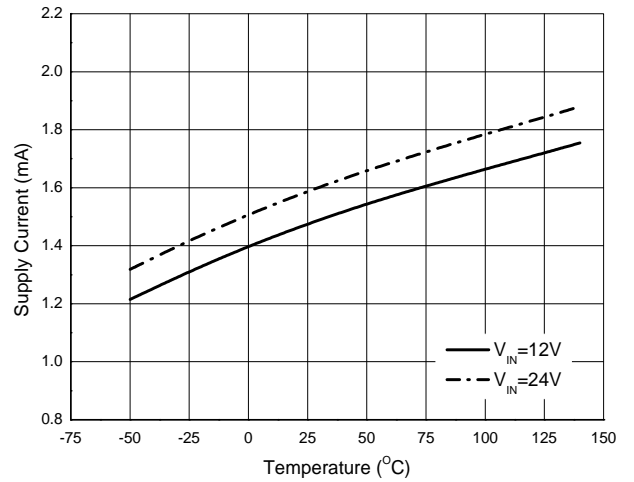

Supply Current vs. Temperature

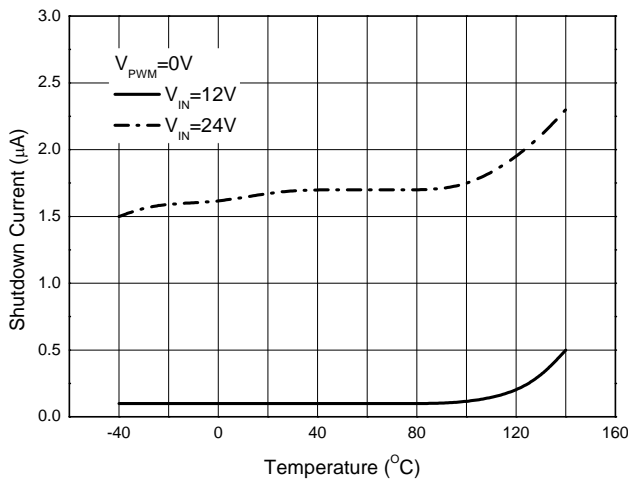

Frequency vs. Temperature

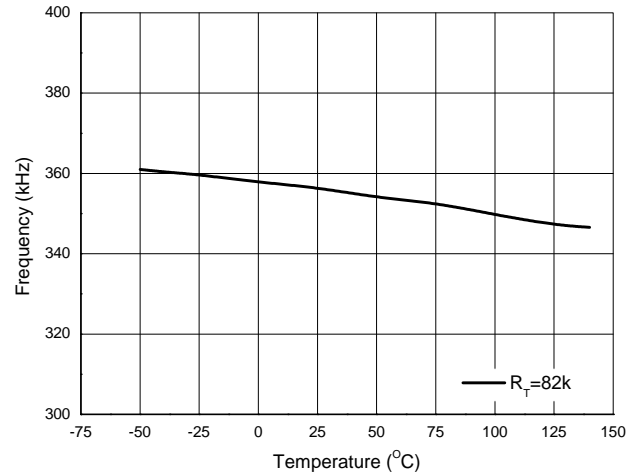

Performance Characteristics (continued)

V_{CC} vs. Input Voltage

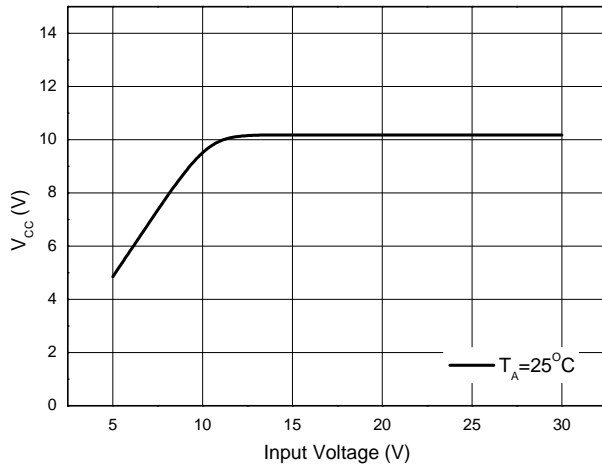

CS Threshold Voltage vs. Temperature

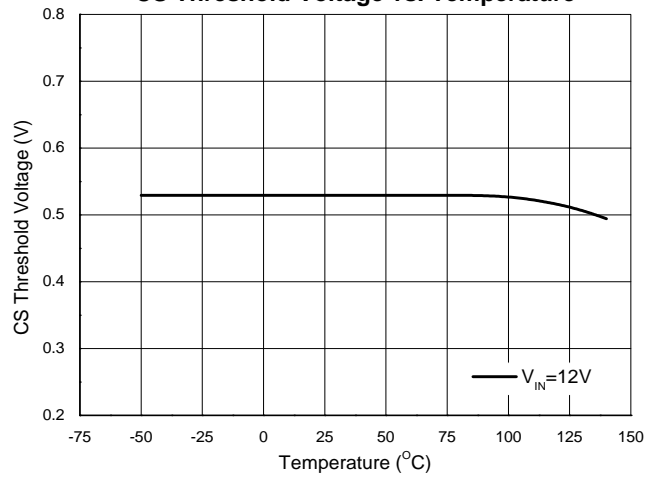

EN Threshold Voltage vs. Temperature

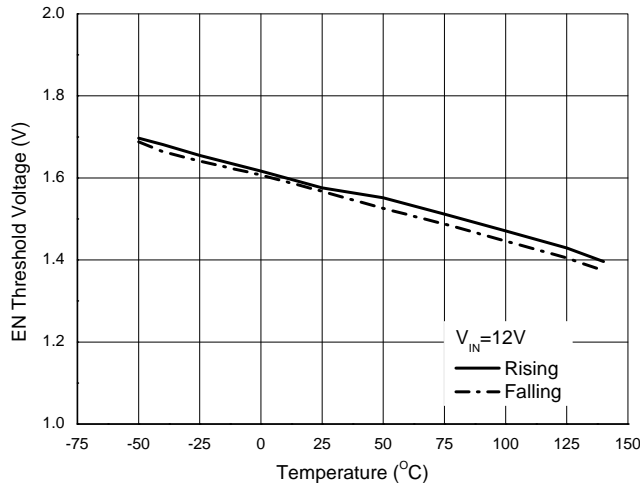

PWM Threshold Voltage vs. Temperature

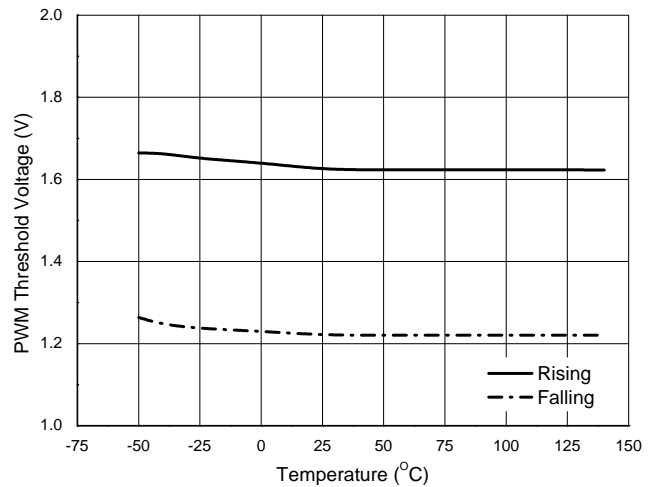

OV Threshold Voltage vs. Temperature

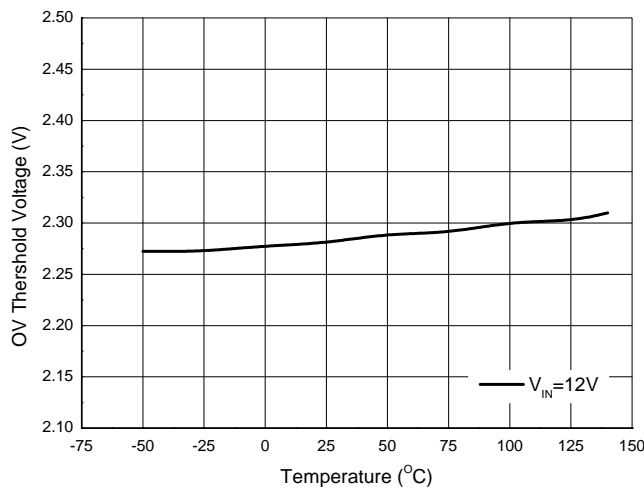

FB Low Threshold Voltage vs. Temperature

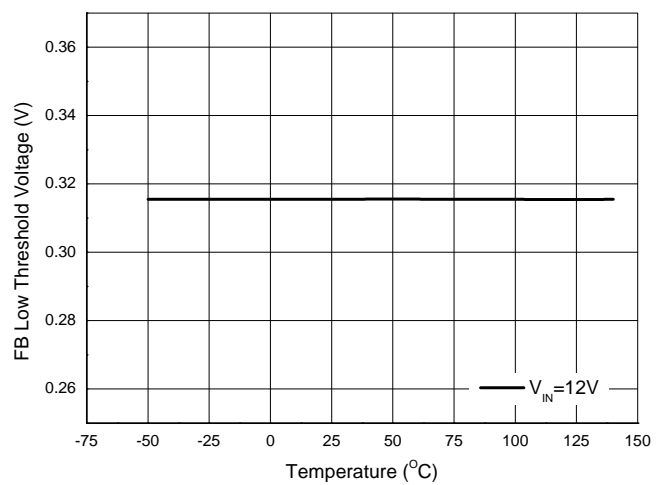

Performance Characteristics (continued)

FB High Threshold Voltage vs. Temperature

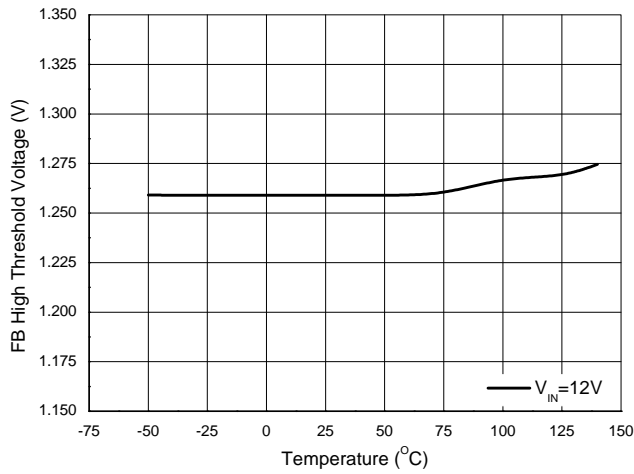

OV Low Threshold Voltage vs. Temperature

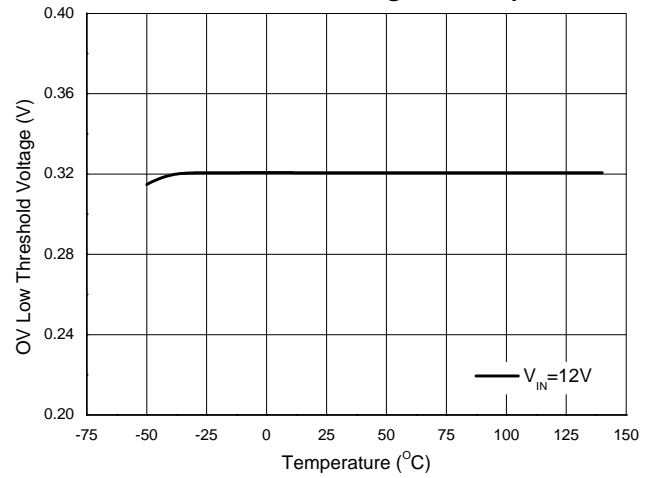

Soft-start Current vs. Temperature

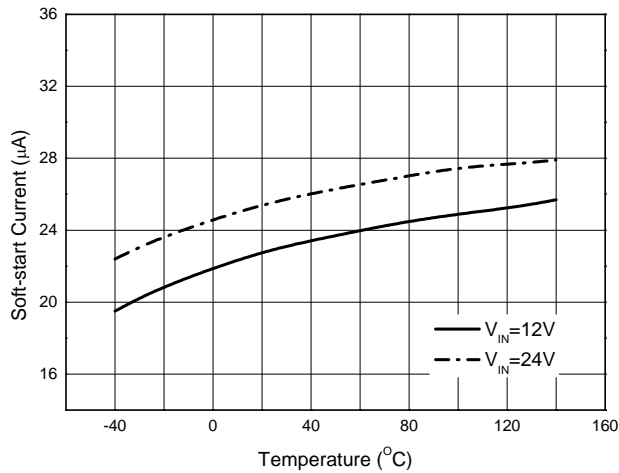

CT Charge Current vs. Temperature

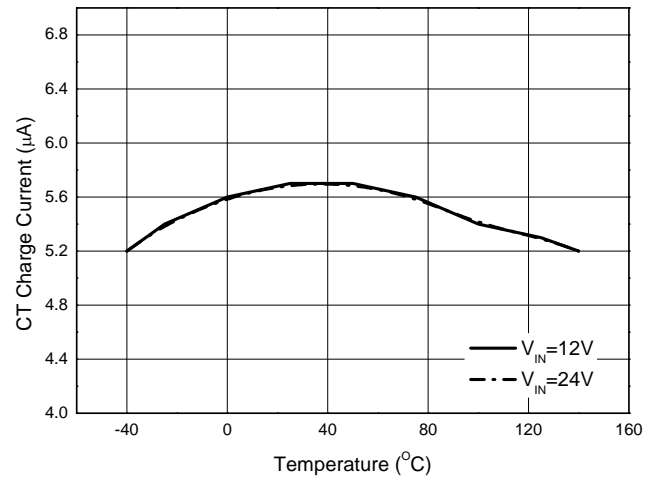

Ordering Information

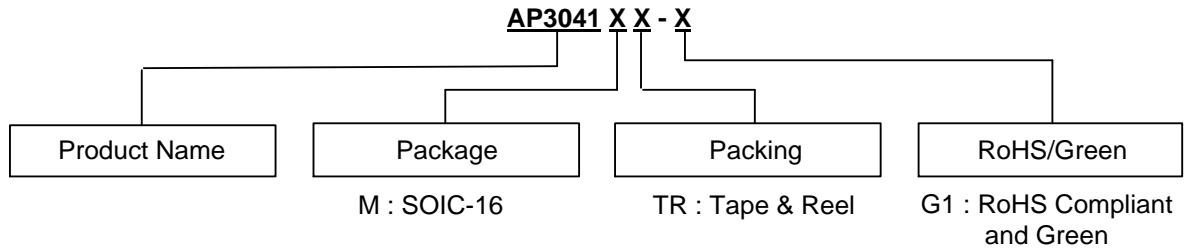

Package	Temperature Range	Part Number	Marking ID	Packing
SOIC-16	-40 to +85°C	AP3041MTR-G1	AP3041M-G1	4,000/13" Tape & Reel

Marking Information

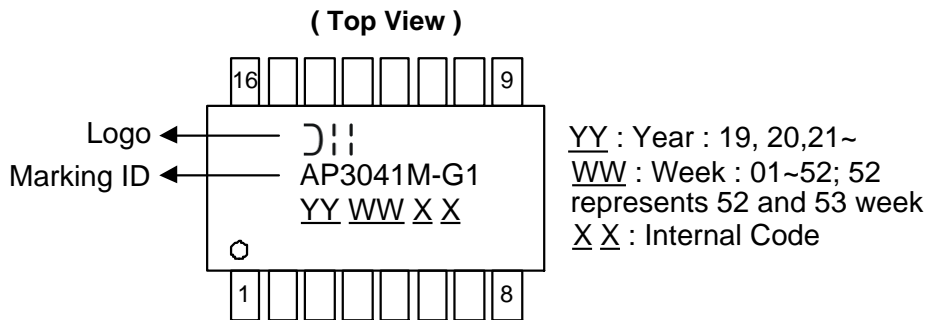

Package Outline Dimensions (All dimensions in mm(inch).)

Please see <http://www.diodes.com/package-outlines.html> for the latest version.

(1) Package Type: **SOIC-16**

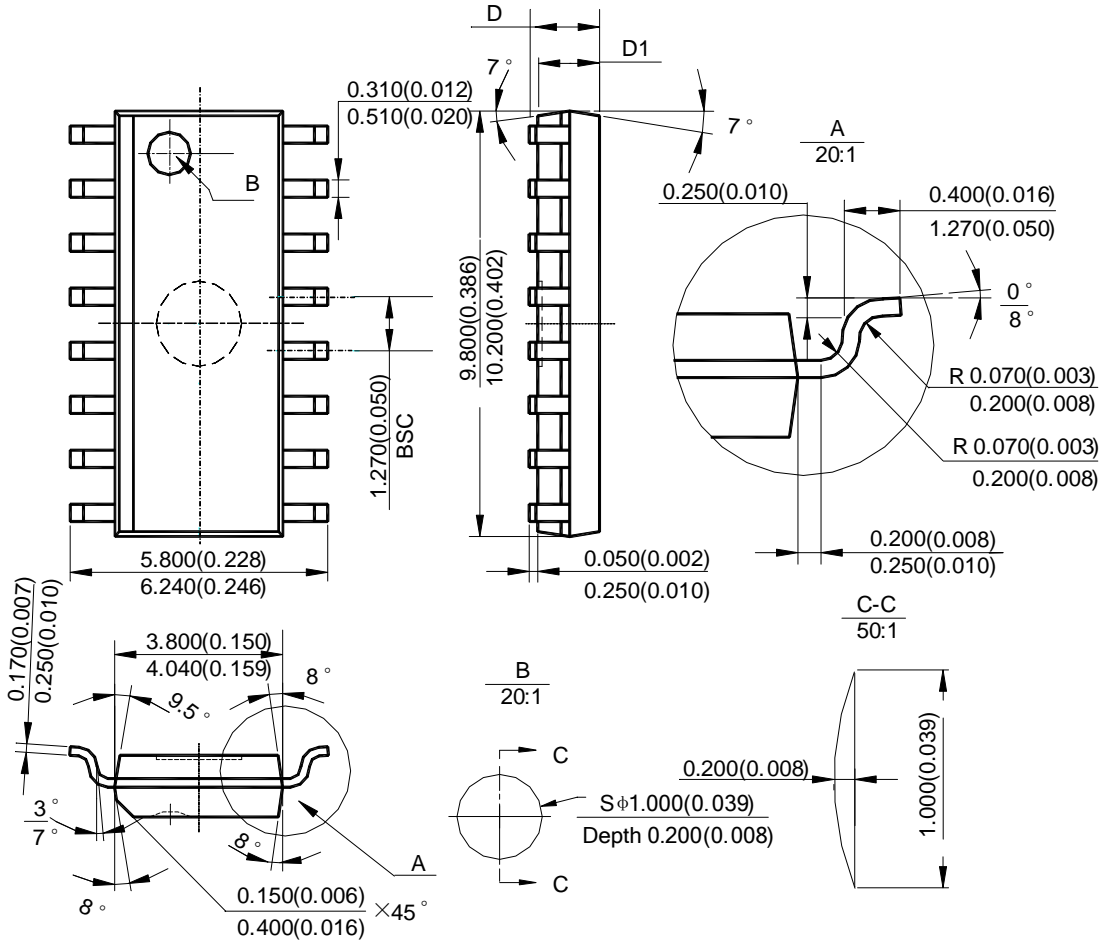

Note: Eject hole, oriented hole and mold mark is optional.

Symbol	D				D1			
	min(mm)	max(mm)	min(inch)	max(inch)	min(mm)	max(mm)	min(inch)	max(inch)
Option1	1.350	1.750	0.053	0.069	1.250	1.650	0.049	0.065
Option2	-	1.260	-	0.050	1.020	-	0.040	-

Suggested Pad Layout

Please see <http://www.diodes.com/package-outlines.html> for the latest version.

(1) Package Type: SOIC-16

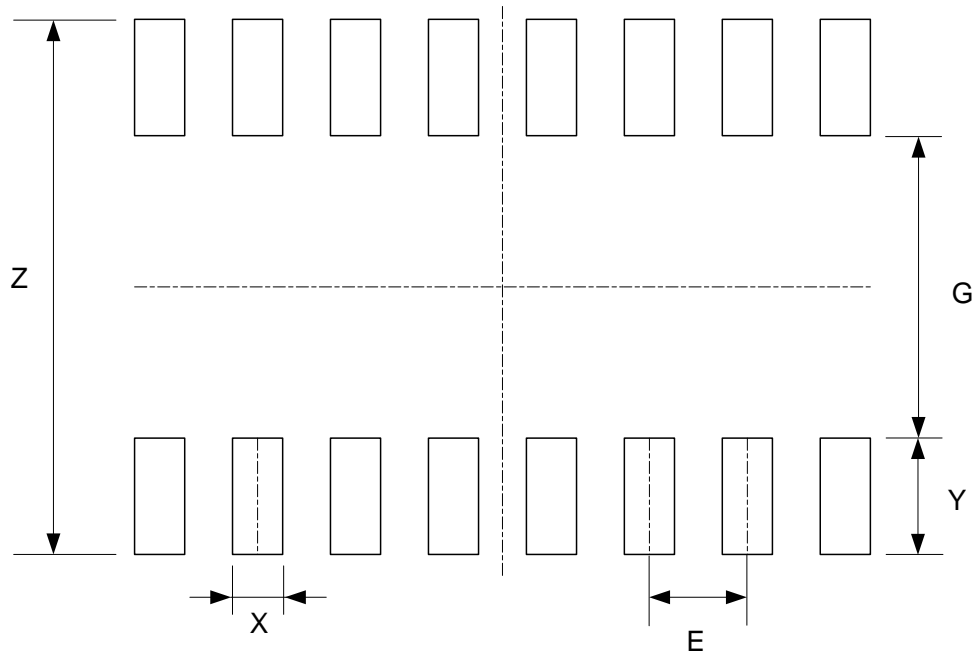

Dimensions	Z (mm)/(inch)	G (mm)/(inch)	X (mm)/(inch)	Y (mm)/(inch)	E (mm)/(inch)
Value	6.900/0.272	3.900/0.154	0.650/0.026	1.500/0.059	1.270/0.050

IMPORTANT NOTICE

DIODES INCORPORATED MAKES NO WARRANTY OF ANY KIND, EXPRESS OR IMPLIED, WITH REGARDS TO THIS DOCUMENT, INCLUDING, BUT NOT LIMITED TO, THE IMPLIED WARRANTIES OF MERCHANTABILITY AND FITNESS FOR A PARTICULAR PURPOSE (AND THEIR EQUIVALENTS UNDER THE LAWS OF ANY JURISDICTION).

Diodes Incorporated and its subsidiaries reserve the right to make modifications, enhancements, improvements, corrections or other changes without further notice to this document and any product described herein. Diodes Incorporated does not assume any liability arising out of the application or use of this document or any product described herein; neither does Diodes Incorporated convey any license under its patent or trademark rights, nor the rights of others. Any Customer or user of this document or products described herein in such applications shall assume all risks of such use and will agree to hold Diodes Incorporated and all the companies whose products are represented on Diodes Incorporated website, harmless against all damages.

Diodes Incorporated does not warrant or accept any liability whatsoever in respect of any products purchased through unauthorized sales channel. Should Customers purchase or use Diodes Incorporated products for any unintended or unauthorized application, Customers shall indemnify and hold Diodes Incorporated and its representatives harmless against all claims, damages, expenses, and attorney fees arising out of, directly or indirectly, any claim of personal injury or death associated with such unintended or unauthorized application.

Products described herein may be covered by one or more United States, international or foreign patents pending. Product names and markings noted herein may also be covered by one or more United States, international or foreign trademarks.

This document is written in English but may be translated into multiple languages for reference. Only the English version of this document is the final and determinative format released by Diodes Incorporated.

LIFE SUPPORT

Diodes Incorporated products are specifically not authorized for use as critical components in life support devices or systems without the express written approval of the Chief Executive Officer of Diodes Incorporated. As used herein:

A. Life support devices or systems are devices or systems which:

1. are intended to implant into the body, or
2. support or sustain life and whose failure to perform when properly used in accordance with instructions for use provided in the labeling can be reasonably expected to result in significant injury to the user.

B. A critical component is any component in a life support device or system whose failure to perform can be reasonably expected to cause the failure of the life support device or to affect its safety or effectiveness.

Customers represent that they have all necessary expertise in the safety and regulatory ramifications of their life support devices or systems, and acknowledge and agree that they are solely responsible for all legal, regulatory and safety-related requirements concerning their products and any use of Diodes Incorporated products in such safety-critical, life support devices or systems, notwithstanding any devices- or systems-related information or support that may be provided by Diodes Incorporated. Further, Customers must fully indemnify Diodes Incorporated and its representatives against any damages arising out of the use of Diodes Incorporated products in such safety-critical, life support devices or systems.

Copyright © 2019, Diodes Incorporated

www.diodes.com

单击下面可查看定价，库存，交付和生命周期等信息

[>>Diodes Incorporated\(达达科技\(美台\)\)](#)