

450V NPN HIGH VOLTAGE POWER TRANSISTOR IN TO92

Features

- $BV_{CEO} > 450V$
- $BV_{CES} > 800V$
- $BV_{EBO} > 9V$
- $I_C = 0.8A$ High Continuous Collector Current
- **Lead-Free Finish; RoHS Compliant (Notes 1 & 2)**
- **Halogen and Antimony Free. "Green" Device (Note 3)**

Applications

Low Power AC-DC SMPS for:

- Battery Chargers for Mobile Phone / Tablets / Smartphones
- Power Supply for DVD / STB
- LED Lighting

Mechanical Data

- Case: TO92
- Case Material: Molded Plastic, "Green" Molding Compound; UL Flammability Classification Rating 94V-0
- Terminals: Matte Tin Finish; Solderable per MIL-STD-202, Method 208 Ⓔ3
- Weight: TO92: 200mg (Approximate)

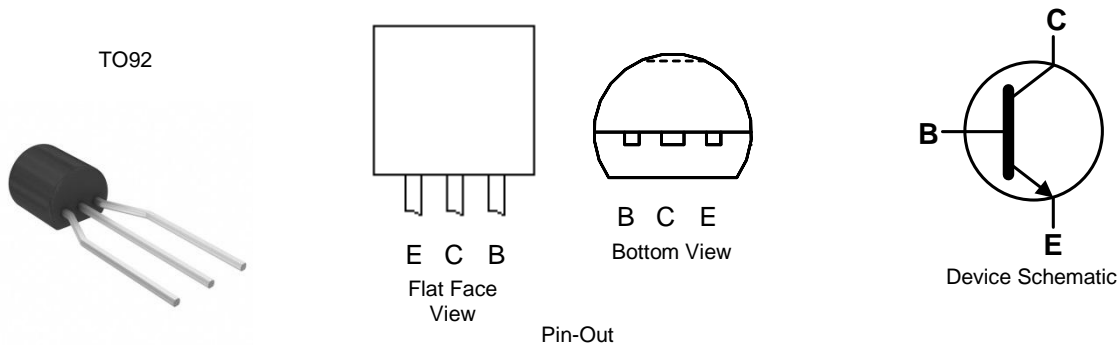

Ordering Information (Note 4)

Product	Package	Marking	Quantity
APT27HZTR-G1	TO92 (Joggled Legs)	APT27HZ-G1	2,000 Taped, per Ammo Box

- Notes:
1. EU Directive 2002/95/EC (RoHS) & 2011/65/EU (RoHS 2) compliant. All applicable RoHS exemptions applied.
 2. See http://www.diodes.com/quality/lead_free.html for more information about Diodes Incorporated's definitions of Halogen- and Antimony-free, "Green" and Lead-free.
 3. Halogen- and Antimony-free "Green" products are defined as those which contain <900ppm bromine, <900ppm chlorine (<1500ppm total Br + Cl) and <1000ppm antimony compounds.
 4. For packaging details, go to our website at <http://www.diodes.com/products/packages.html>.

Marking Information

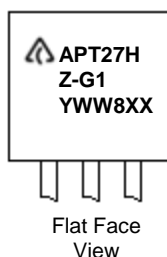

- △ = Manufacturers' code marking
- APT27HZ-G1 = Product Type Marking ID
- YWW = Date Code Marking
e.g 312 = Year 2013, Week 12
- 8 = Assembly site code
- XX = Batch Number

Absolute Maximum Ratings (@ $T_A = +25^\circ\text{C}$, unless otherwise specified.)

Characteristic	Symbol	Value	Unit
Collector-Emitter Voltage ($V_{BE} = 0\text{V}$)	V_{CES}	800	V
Collector-Emitter Voltage	V_{CEO}	450	V
Emitter-Base Voltage	V_{EBO}	9	V
Continuous Collector Current	I_C	0.8	A
Peak Pulse Collector Current	I_{CM}	1.6	A
Continuous Base Current	I_B	0.4	A
Peak Pulse Base Current	I_{BM}	0.8	A

Thermal Characteristics (@ $T_A = +25^\circ\text{C}$, unless otherwise specified.)

Characteristic	Symbol	Value	Unit
Power Dissipation	P_D	0.8	W
Thermal Resistance, Junction to Ambient Air	$R_{\theta JA}$	156.25	$^\circ\text{C}/\text{W}$
Operating and Storage Temperature Range	T_J, T_{STG}	-55 to +150	$^\circ\text{C}$

ESD Ratings (Note 5)

Characteristic	Symbol	Value	Unit	JEDEC Class
Electrostatic Discharge - Human Body Model	ESD HBM	8,000	V	3B
Electrostatic Discharge - Machine Model	ESD MM	400	V	C

Note: 5. Refer to JEDEC specification JESD22-A114 and JESD22-A115.

Safe Operating Area and Derating Information (@ $T_A = +25^\circ\text{C}$, unless otherwise specified.)

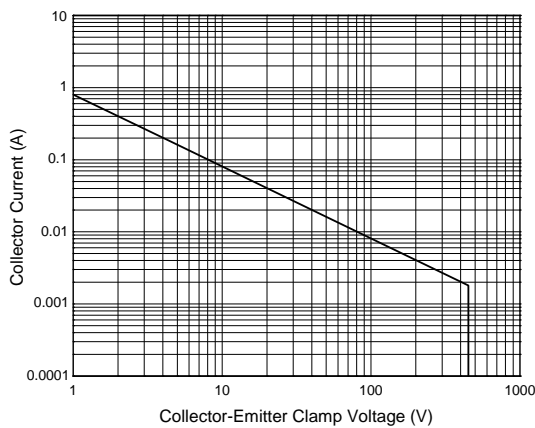

Safe Operating Areas

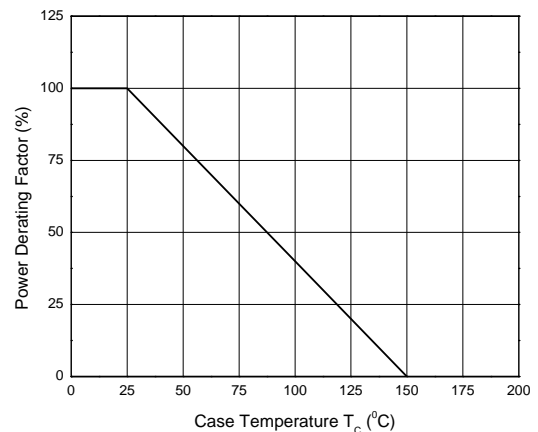

Power Derating Curve

Electrical Characteristics (@ $T_A = +25^\circ\text{C}$, unless otherwise specified.)

Characteristic	Symbol	Min	Typ	Max	Unit	Test Condition
Collector-Emitter Breakdown Voltage	BV_{CES}	800	—	—	V	$I_C = 100\mu\text{A}$, $V_{BE} = 0\text{V}$
Collector-Emitter Breakdown Voltage	BV_{CEO}	450	—	—	V	$I_C = 100\mu\text{A}$
Emitter-Base Breakdown Voltage	BV_{EBO}	9	—	—	V	$I_E = 100\mu\text{A}$
Collector Cutoff Current	I_{CEV}	—	—	10	μA	$V_{CE} = 800\text{V}$, $V_{BE} = -1.5\text{V}$
Collector-Emitter Saturation Voltage	$V_{CE(sat)}$	—	—	0.5	V	$I_C = 200\text{mA}$, $I_B = 40\text{mA}$
DC Current Transfer Static Ratio (Note 6)	h_{FE}	15	23	40	—	$I_C = 100\text{mA}$, $V_{CE} = 10\text{V}$ $I_C = 300\text{mA}$, $V_{CE} = 10\text{V}$

Note: 6. Measured under pulsed conditions. Pulse width $\leq 300\mu\text{s}$. Duty cycle $\leq 2\%$.

Typical Electrical Characteristics (@ $T_A = +25^\circ\text{C}$, unless otherwise specified.)

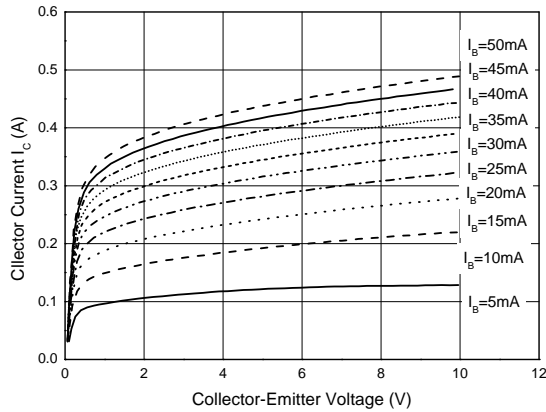

Static Characteristics

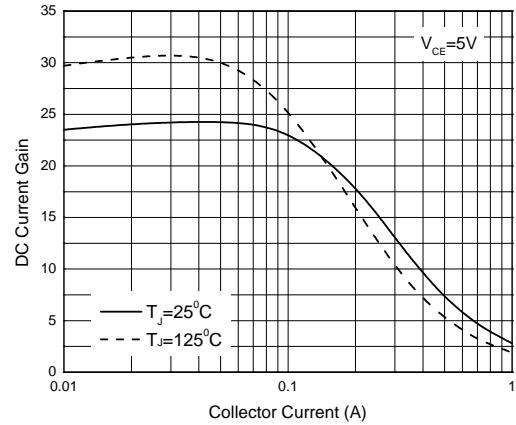

DC Current Gain

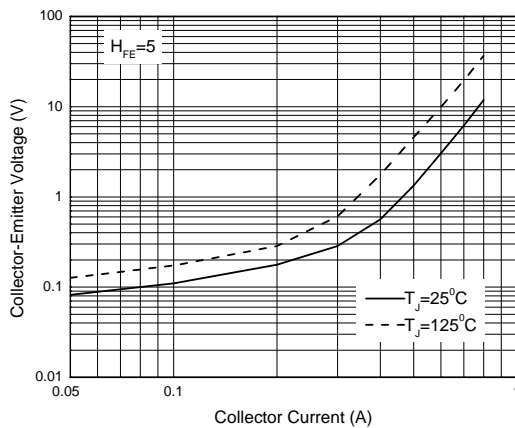

Collector-Emitter Saturation Region

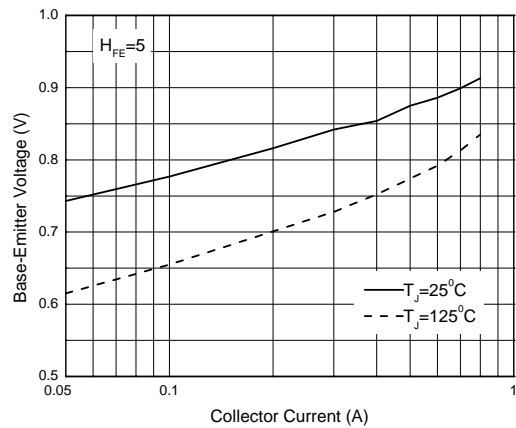

Base-Emitter Saturation Voltage

Package Outline Dimensions

Please see AP02002 at <http://www.diodes.com/datasheets/ap02002.pdf> for latest version.

(1) Package Type: T092 Type C

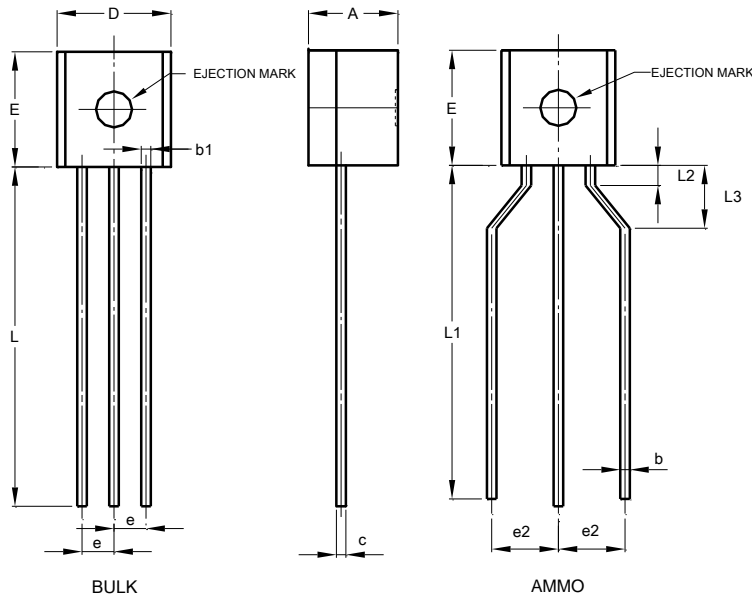

T092 Type C			
Dim	Min	Max	Typ
A	3.30	3.70	-
A2	1.10	1.40	-
b	0.38	0.55	-
c	0.36	0.51	-
D	4.40	4.70	-
D1	3.430	-	-
E	4.30	4.70	-
e	-	-	1.27
e2	2.440	2.640	-
h	0.00	0.38	-
L	14.10	14.50	-
L1	12.50	14.50	-
L3	2.50	3.50	-
ø	-	1.60	-
All Dimensions in mm			

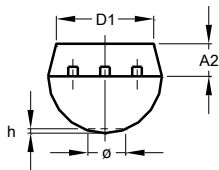

Note: For high voltage applications, the appropriate industry sector guidelines should be considered with regards to creepage and clearance distances between device Terminals and PCB tracking.

IMPORTANT NOTICE

DIODES INCORPORATED MAKES NO WARRANTY OF ANY KIND, EXPRESS OR IMPLIED, WITH REGARDS TO THIS DOCUMENT, INCLUDING, BUT NOT LIMITED TO, THE IMPLIED WARRANTIES OF MERCHANTABILITY AND FITNESS FOR A PARTICULAR PURPOSE (AND THEIR EQUIVALENTS UNDER THE LAWS OF ANY JURISDICTION).

Diodes Incorporated and its subsidiaries reserve the right to make modifications, enhancements, improvements, corrections or other changes without further notice to this document and any product described herein. Diodes Incorporated does not assume any liability arising out of the application or use of this document or any product described herein; neither does Diodes Incorporated convey any license under its patent or trademark rights, nor the rights of others. Any Customer or user of this document or products described herein in such applications shall assume all risks of such use and will agree to hold Diodes Incorporated and all the companies whose products are represented on Diodes Incorporated website, harmless against all damages.

Diodes Incorporated does not warrant or accept any liability whatsoever in respect of any products purchased through unauthorized sales channel. Should Customers purchase or use Diodes Incorporated products for any unintended or unauthorized application, Customers shall indemnify and hold Diodes Incorporated and its representatives harmless against all claims, damages, expenses, and attorney fees arising out of, directly or indirectly, any claim of personal injury or death associated with such unintended or unauthorized application.

Products described herein may be covered by one or more United States, international or foreign patents pending. Product names and markings noted herein may also be covered by one or more United States, international or foreign trademarks.

This document is written in English but may be translated into multiple languages for reference. Only the English version of this document is the final and determinative format released by Diodes Incorporated.

LIFE SUPPORT

Diodes Incorporated products are specifically not authorized for use as critical components in life support devices or systems without the express written approval of the Chief Executive Officer of Diodes Incorporated. As used herein:

A. Life support devices or systems are devices or systems which:

1. are intended to implant into the body, or
2. support or sustain life and whose failure to perform when properly used in accordance with instructions for use provided in the labeling can be reasonably expected to result in significant injury to the user.

B. A critical component is any component in a life support device or system whose failure to perform can be reasonably expected to cause the failure of the life support device or to affect its safety or effectiveness.

Customers represent that they have all necessary expertise in the safety and regulatory ramifications of their life support devices or systems, and acknowledge and agree that they are solely responsible for all legal, regulatory and safety-related requirements concerning their products and any use of Diodes Incorporated products in such safety-critical, life support devices or systems, notwithstanding any devices- or systems-related information or support that may be provided by Diodes Incorporated. Further, Customers must fully indemnify Diodes Incorporated and its representatives against any damages arising out of the use of Diodes Incorporated products in such safety-critical, life support devices or systems.

Copyright © 2014, Diodes Incorporated

www.diodes.com

单击下面可查看定价，库存，交付和生命周期等信息

[>>Diodes Incorporated\(达尔科技\)](#)