



A Product Line of  
Diodes Incorporated



## SPECIFICATION FOR APPROVAL

CUSTOMER \_\_\_\_\_

NOMINAL FREQUENCY \_\_\_\_\_ 14.318180 MHz \_\_\_\_\_



HOLDER TYPE \_\_\_\_\_ **TYPE GF 49S SMD QUARTZ CRYSTAL** \_\_\_\_\_

SPEC. NO. ( P/N ) \_\_\_\_\_ GF1430012 \_\_\_\_\_

CUSTOMER P/N \_\_\_\_\_

ISSUE DATE \_\_\_\_\_ February 9, 2018 \_\_\_\_\_

VERSION \_\_\_\_\_ C \_\_\_\_\_

APPROVED	PREPARED	QA
		

### Diodes Incorporated

No.2, Ziqiang 5th Rd., Zhongli Industrial Park,  
Zhongli Dist., Taoyuan City 32063, Taiwan (R.O.C.)  
TEL: 886-3-451-8888  
FAX: 886-3-461-3865  
<https://www.diodes.com>

\*RoHS Compliant  
\*HF-Halogen Free  
\*REACH Compliant



# TYPE GF 49S SMD QUARTZ CRYSTAL

## GF1430012

VER. C 9-Feb-18

### ELECTRICAL SPECIFICATIONS

Item	Symbol	Specifications	Units	Notes
Nominal Frequency	F <sub>n</sub>	14.318180	MHz	
Mode of Oscillation	MO	AT Cut-Fundamental		
Calibration Load Capacitance	CL	20	pF	
Calibration Tolerance	FL	±30	ppm	at 25°C±3°C
Operating Temperature Range	TR	-20 to +70	°C	
Frequency Stability (Frequency Deviation over the Operating Temperature Range)	F/T	±30	ppm	Reference to the Frequency at 25°C
Operating Drive Level		100	μW	
Maximum Drive Level		500	μW	
Equivalent Series Resistance	ESR	50	Ω	Max
Shunt Capacitance	C <sub>0</sub>	7	pF	Max
Aging at 25°C		±5	ppm	Max, 1st year
Storage Temperature		-55 to +125	°C	
Insulation Resistance		500	MΩ	Min

# TYPE GF 49S SMD QUARTZ CRYSTAL

**GF1430012**

VER. C 0-Jan-00

## RELIABILITY SPECIFICATIONS

### MECHANICAL AND ENVIRONMENTAL RATINGS:

- a) FINE LEAK TEST: JESD22-A109 (Condition 1A)
- b) GROSS LEAK TEST: JESD22-A109 (Condition C)
- c) MOISTURE RESISTANCE: JESD22-A113
- d) SHOCK: JESD22-B104 (Condition B)
- e) SOLDERABILITY : (RoHS version): J-STD-002
- f) VIBRATION: JESD22-B103
- g) SOLVENT RESISTANCE: JESD22-B107
- h) RESISTANCE TO SOLDERING HEAT (RoHS version): J-STD-020D Table 5.2 Pb free devices (3 cycles max)

## SUGGESTED IR REFLOW PROFILE

\*As per IPC-JEDEC J-STD-020D

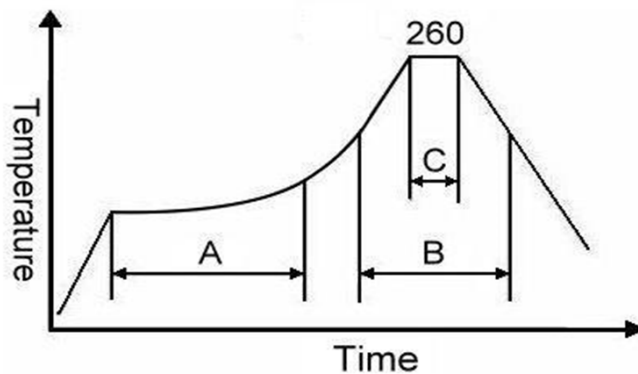

Note:

	Stage	Temperature	Time
A	Preheat	150~200°C	60~120 Sec
B	Primary Heat	217°C	60~150 Sec
C	Peak	260°C	10 Sec

# TYPE GF 49S SMD QUARTZ CRYSTAL

## GF1430012

VER. C 9-Feb-18

### MARKING

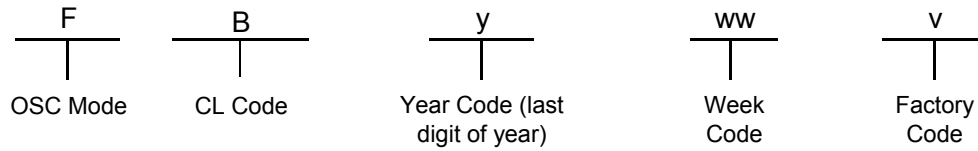

### MECHANICAL DRAWINGS ( Scale: None. Dimensions are in mm.)

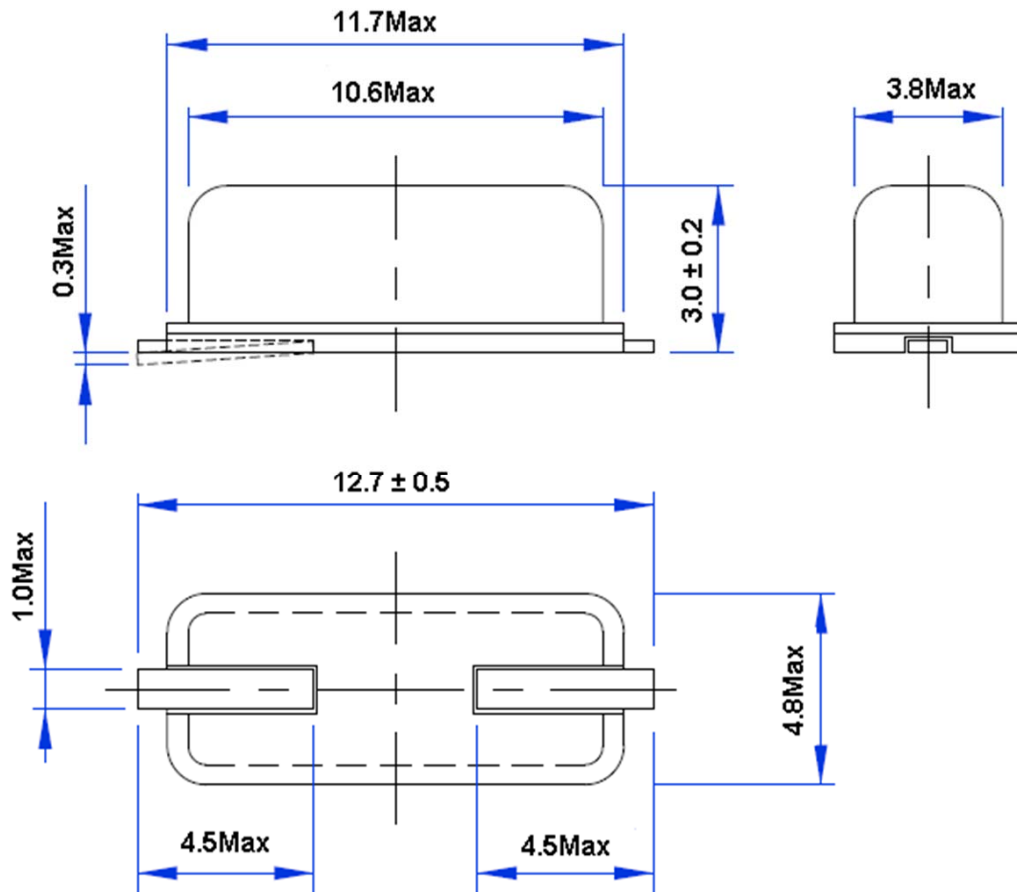

# TYPE GF 49S SMD QUARTZ CRYSTAL

GF1430012

VER. C 9-Feb-18

## PACKING

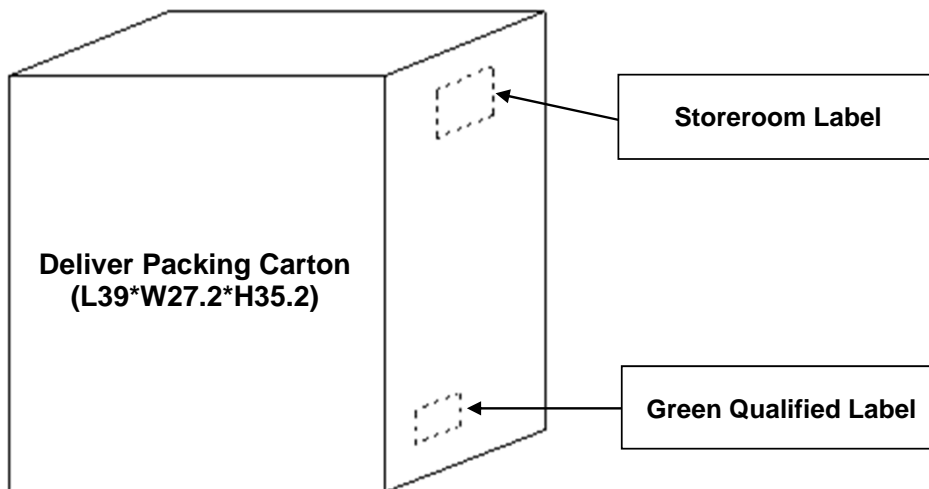
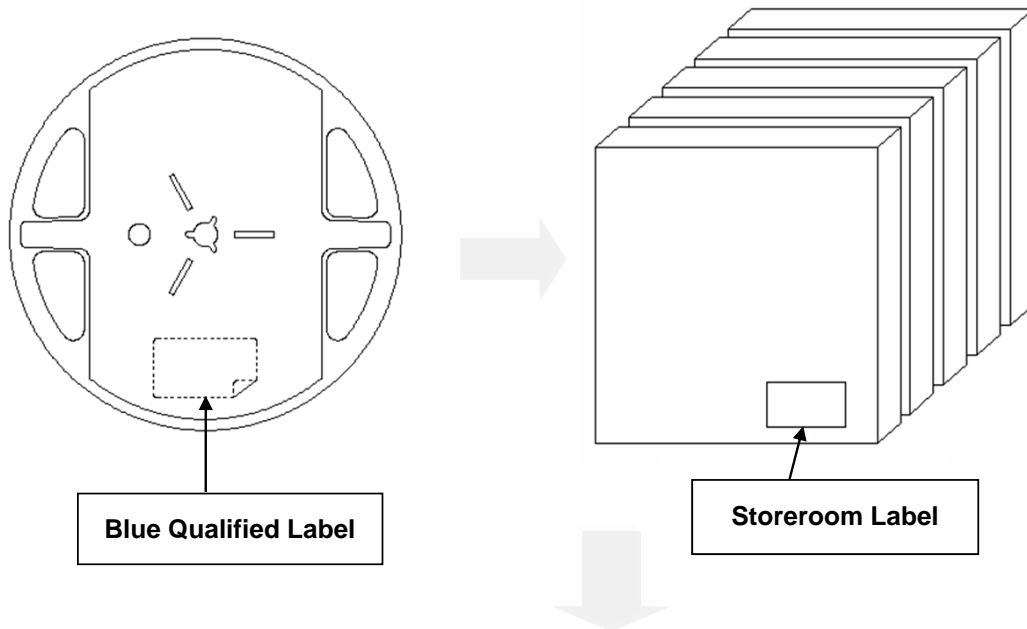
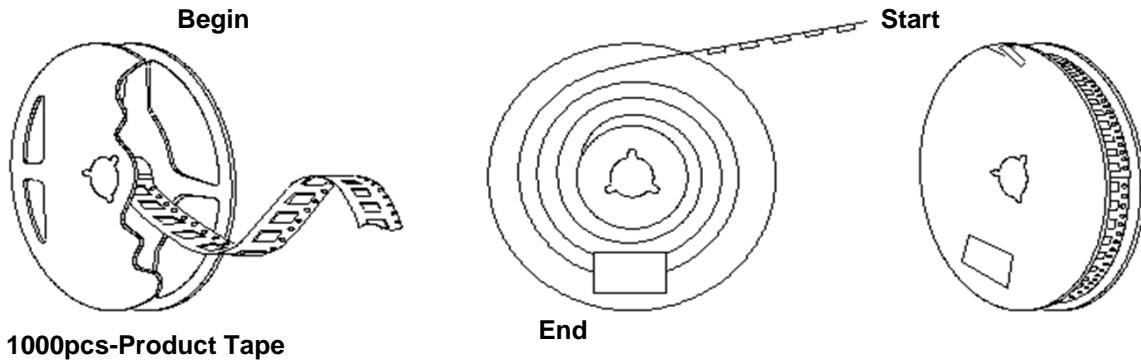

单击下面可查看定价，库存，交付和生命周期等信息

[>>Diodes Incorporated\(达达科技\(美台\)\)](#)