

Features

- Quad TVS in Common Anode Configuration
- Ultra-Small Surface Mount Package
- Ideal For Transient Suppression and ESD Protection
- **Lead Free By Design/RoHS Compliant (Note 1)**
- **"Green Device" (Note 2)**
- **Qualified to AEC-Q101 Standards for High Reliability**

ESD Capability

- IEC 61000-4-2 Contact Method $\pm 8\text{kV}$
- IEC 61000-4-2 Air Discharge Method $\pm 15\text{kV}$

Mechanical Data

- Case: SOT553
- Case Material: Molded Plastic, "Green" Molding Compound. UL Flammability Classification Rating 94V-0
- Moisture Sensitivity: Level 1 per J-STD-020
- Terminal Finish: Matte Tin, Annealed Over Copper Leadframe. Solderable per MIL-STD-202, Method 208
- Weight: 0.002 grams (approximate)

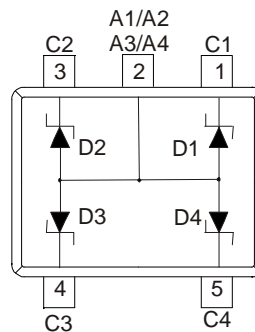

TOP VIEW
Device Schematic

Ordering Information (Note 3)

Part Number	Case	Packaging
DZQA6V8AXV5-7	SOT553	3000/Tape & Reel

- Notes:
1. No purposefully added lead.
 2. Diodes Inc.'s "Green" policy can be found on our website at <http://www.diodes.com>.
 3. For packaging details, go to our website at <http://www.diodes.com>.

Marking Information

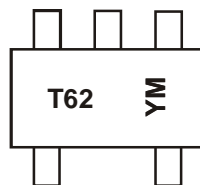

T62 = Product type marking code
 YM = Date code marking
 Y = Year (Ex: W = 2009)
 M = Month (ex: 9 = September)

Date Code Key

Year	2009	2010	2011	2012	2013	2014	2015
Code	W	X	Y	Z	A	B	C

Month	Jan	Feb	Mar	Apr	May	Jun	Jul	Aug	Sep	Oct	Nov	Dec
Code	1	2	3	4	5	6	7	8	9	O	N	D

Maximum Ratings @ $T_A = 25^\circ\text{C}$ unless otherwise specified

Characteristic	Symbol	Value	Unit
Forward Voltage @ $I_F = 10\text{mA}$	V_F	0.9	V

Thermal Characteristics

Characteristic	Symbol	Value	Unit
Power Dissipation (Notes 4 & 5)	P_D	380	mW
Peak Power Dissipation, 8x20 μs Waveform (Note 6)	P_{pk}	20	W
Thermal Resistance, Junction-to-Ambient (Note 4)	$R_{\theta JA}$	327	$^\circ\text{C/W}$
Operating and Storage Temperature Range	T_J, T_{STG}	-55 to +150	$^\circ\text{C}$

Electrical Characteristics @ $T_A = 25^\circ\text{C}$ unless otherwise specified

Type Number	Marking Code	Breakdown Voltage (Note 7)			Leakage Current (Note 7)		Clamping Voltage (Note 6)		Capacitance @0V Bias(pF) (Note 8)		Capacitance @3V Bias(pF) (Note 8)	
		$V_{BR} @ I_T = 1\text{mA}$			$I_{RM} @ V_{RM}$		$V_C \text{ Max } @ I_{PP}$		C_T		C_T	
		Min (V)	Nom (V)	Max (V)	Max(μA)	(V)	V_C (V)	I_{PP} (A)	Typ	Max	Typ	Max
DZQA6V8AXV5	T62	6.47	6.8	7.14	1	4.3	13	1.6	12.5	15	7.6	9.5

- Notes:
- Device mounted on FR-4 PCB, 1 inch x 0.85 inch x 0.062 inch; pad layout as shown on Diodes Inc. Suggested Pad Layout Document AP02001, which can be found on our website at <http://www.diodes.com>.
 - Only 1 diode under power. For all 4 diodes under power, P_D will be 25% of the listed value.
 - Non-repetitive current pulse per Figure 3 and derate above $T_A = 25^\circ\text{C}$ per Figure 1.
 - Short duration pulse test used to minimize self-heating effect.
 - Per element, $f = 1\text{MHz}$, $T_A = 25^\circ\text{C}$

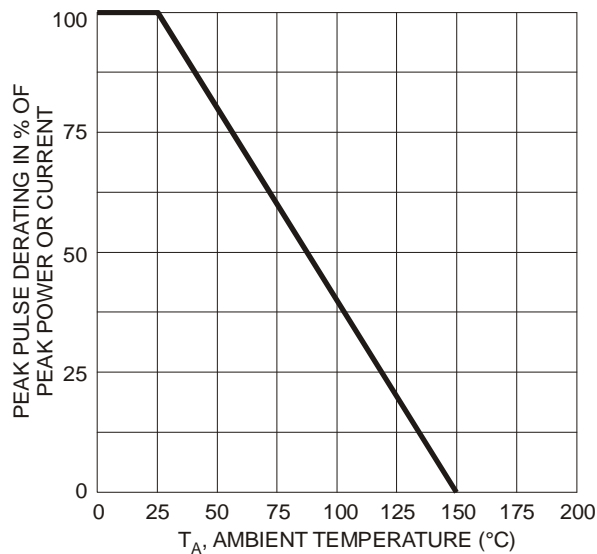

Fig. 1 Pulse Derating Curve

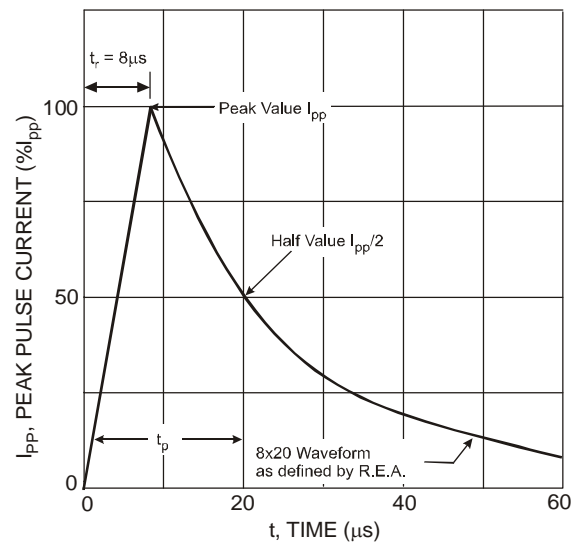

Fig. 2 Pulse Waveform

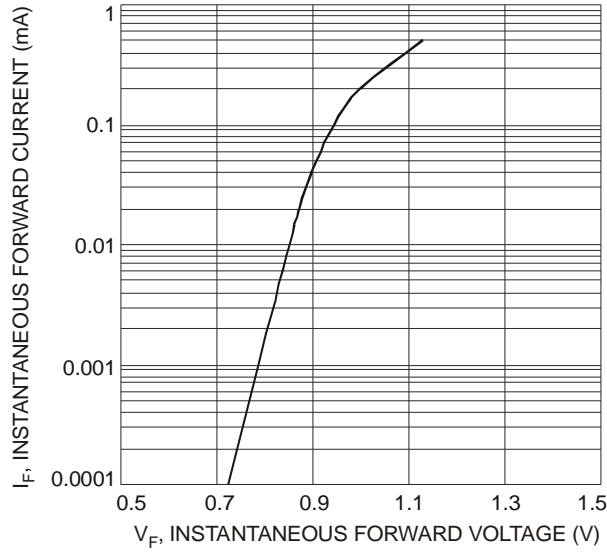

Fig. 3 Typical Forward Characteristics

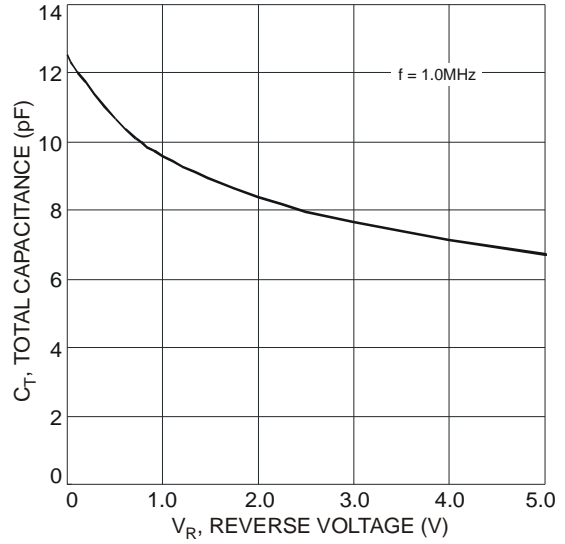
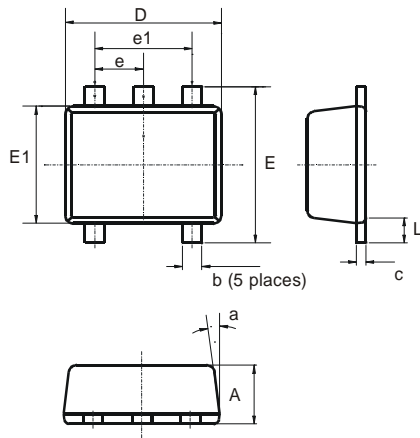

Fig. 4 Typical Total Capacitance vs. Reverse Voltage (Per Element)

Package Outline Dimensions



SOT553			
Dim	Min	Max	Typ
A	0.55	0.60	0.60
c	0.10	0.18	0.15
D	1.50	1.70	1.60
E	1.55	1.70	1.60
E1	1.10	1.25	1.20
L	0.10	0.30	0.20
b	0.15	0.30	0.20
e	0.50 Typ		
e1	1.00 Typ		
a	6°	8°	7°
All Dimensions in mm			

Suggested Pad Layout

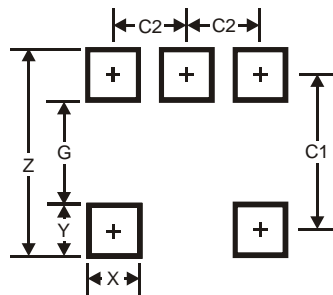

Dimensions	Value (in mm)
Z	2.2
G	1.2
X	0.375
Y	0.5
C1	1.7
C2	0.5

IMPORTANT NOTICE

DIODES INCORPORATED MAKES NO WARRANTY OF ANY KIND, EXPRESS OR IMPLIED, WITH REGARDS TO THIS DOCUMENT, INCLUDING, BUT NOT LIMITED TO, THE IMPLIED WARRANTIES OF MERCHANTABILITY AND FITNESS FOR A PARTICULAR PURPOSE (AND THEIR EQUIVALENTS UNDER THE LAWS OF ANY JURISDICTION).

Diodes Incorporated and its subsidiaries reserve the right to make modifications, enhancements, improvements, corrections or other changes without further notice to this document and any product described herein. Diodes Incorporated does not assume any liability arising out of the application or use of this document or any product described herein; neither does Diodes Incorporated convey any license under its patent or trademark rights, nor the rights of others. Any Customer or user of this document or products described herein in such applications shall assume all risks of such use and will agree to hold Diodes Incorporated and all the companies whose products are represented on Diodes Incorporated website, harmless against all damages.

Diodes Incorporated does not warrant or accept any liability whatsoever in respect of any products purchased through unauthorized sales channel. Should Customers purchase or use Diodes Incorporated products for any unintended or unauthorized application, Customers shall indemnify and hold Diodes Incorporated and its representatives harmless against all claims, damages, expenses, and attorney fees arising out of, directly or indirectly, any claim of personal injury or death associated with such unintended or unauthorized application.

Products described herein may be covered by one or more United States, international or foreign patents pending. Product names and markings noted herein may also be covered by one or more United States, international or foreign trademarks.

LIFE SUPPORT

Diodes Incorporated products are specifically not authorized for use as critical components in life support devices or systems without the express written approval of the Chief Executive Officer of Diodes Incorporated. As used herein:

A. Life support devices or systems are devices or systems which:

1. are intended to implant into the body, or
2. support or sustain life and whose failure to perform when properly used in accordance with instructions for use provided in the labeling can be reasonably expected to result in significant injury to the user.

B. A critical component is any component in a life support device or system whose failure to perform can be reasonably expected to cause the failure of the life support device or to affect its safety or effectiveness.

Customers represent that they have all necessary expertise in the safety and regulatory ramifications of their life support devices or systems, and acknowledge and agree that they are solely responsible for all legal, regulatory and safety-related requirements concerning their products and any use of Diodes Incorporated products in such safety-critical, life support devices or systems, notwithstanding any devices- or systems-related information or support that may be provided by Diodes Incorporated. Further, Customers must fully indemnify Diodes Incorporated and its representatives against any damages arising out of the use of Diodes Incorporated products in such safety-critical, life support devices or systems.

Copyright © 2011, Diodes Incorporated

www.diodes.com

单击下面可查看定价，库存，交付和生命周期等信息

[>>Diodes Incorporated\(达达科技\(美台\)\)](#)