

## Description

The ZXRE330 is a low knee current 3.3V voltage reference. Offering tight tolerances and sharp knee characteristics – consuming only 1µA when the 3.3V reference voltage can no longer be maintained.

Excellent performance is maintained over the 1µA to 5mA operating current range. The device has been designed to be highly tolerant of capacitive loads so maintaining excellent stability.

It's available in small outline SOT23 and TO92 packages. This device offers a pin for pin compatible alternative to industry standard shunt voltage reference.

## Features

- Small Packages: SOT23 & TO92
- No Output Capacitor Required
- Output Voltage Tolerance
- ZXRE330E: ±2% at +25°C
- ZXRE330A: ±0.5% at +25°C
- Low Output Noise
  - 55µV<sub>RMS</sub> (10Hz to 10 kHz)
- Wide Operating Current Range 1µA to 5mA
- Extended Temperature Range -40°C to +85°C
- Low Temperature Coefficient 20ppm/°C (Typ)
- **Totally Lead-Free & Fully RoHS Compliant (Notes 1 & 2)**
- **Halogen and Antimony Free. "Green" Device (Note 3)**

Notes:

1. No purposely added lead. Fully EU Directive 2002/95/EC (RoHS), 2011/65/EU (RoHS 2) & 2015/863/EU (RoHS 3) compliant.
2. See <https://www.diodes.com/quality/lead-free/> for more information about Diodes Incorporated's definitions of Halogen- and Antimony-free, "Green" and Lead-free.
3. Halogen- and Antimony-free "Green" products are defined as those which contain <900ppm bromine, <900ppm chlorine (<1500ppm total Br + Cl) and <1000ppm antimony compounds.

## Pin Assignments

ZXRE330xSA (SOT23)

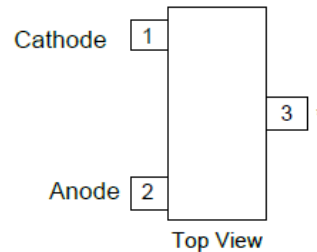

\* Pin 3 must be left floating or connected to pin 2

ZXRE330xV (TO92)

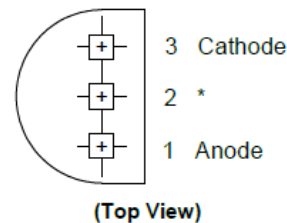

\* Pin 2 must be left floating or connected to pin 1

## Applications

- Battery-Powered Equipment
- Precision Power Supplies
- Portable Instrumentation
- Portable Communications Devices
- Notebook and Palmtop Computers
- Data Acquisition Systems
- Low Current Voltage Clamps

**Typical Applications Circuit**

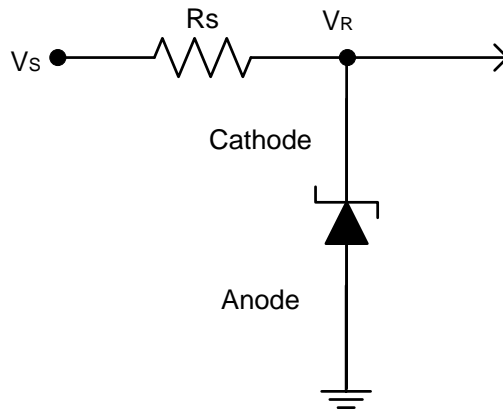

**Absolute Maximum Ratings** (@ $T_A = +25^\circ\text{C}$ , unless otherwise specified.) (Voltages to GND, unless otherwise stated.)

Parameter	Rating	Unit
Continuous Reverse Current	10	mA
Continuous Forward Current	10	mA
Operating Junction Temperature	-40 to +150	$^\circ\text{C}$
Storage Temperature	-65 to +150	$^\circ\text{C}$

Note: 4. Operation above the absolute maximum rating may cause device failure. Operation at the absolute maximum rating, for extended periods, may reduce device reliability. Unless otherwise stated voltages specified are relative to the ANODE pin.

**Package Thermal Data**

Package	$\theta_{JA}$	$P_{DIS}$ $T_{AMB} = +25^\circ\text{C}, T_J = +150^\circ\text{C}$
SOT23	415 $^\circ\text{C}/\text{W}$	300mW
TO92	180 $^\circ\text{C}/\text{W}$	700mW

**Recommended Operating Conditions** (@ $T_A = +25^\circ\text{C}$ , unless otherwise specified.)

Parameter	Min.	Max.	Unit
Reverse Current	0.002	5	mA
Operating Ambient Temperature Range	-40	+85	$^\circ\text{C}$

**Electrical Characteristics** (@T<sub>A</sub> = +25°C, unless otherwise specified.)

Symbol	Parameter	Conditions		Typ	E Limits	Unit
		—	T <sub>AMB</sub>			
V <sub>REF</sub>	Reverse Breakdown Voltage	I <sub>R</sub> = 100μA	+25°C	3.3	—	V
	Reverse Breakdown Voltage Tolerance	I <sub>R</sub> = 100μA	+25°C	—	±16.5	mV
			ZXRE330A ZXRE330E		±66	
			-40 to +85°C		±99	
I <sub>ROFF</sub>	Off state Reverse Current	V = V <sub>REF</sub> * 0.9	+25°C	0.5	—	μA
			-40 to +85°C	—	1	
ΔV <sub>R</sub> /ΔT	Average Reverse Breakdown Voltage Temperature Coefficient	I <sub>R</sub> = 5mA	-40 to +85°C	±20	—	—
		I <sub>R</sub> = 100μA		±15	±150	ppm/°C
		I <sub>R</sub> = 10μA		±15	—	—
ΔV <sub>R</sub>	Reverse Breakdown Change With Current	2μA < I <sub>R</sub> < 100μA	25°C	0.2	—	mV
			-40 to +85°C	—	0.6	
		100μA < I <sub>R</sub> < 5mA	25°C	10	—	
			-40 to +85°C	—	20	
I <sub>RMIN</sub>	Minimal Operating Current	—	—	1	2	μA
Z <sub>R</sub>	Dynamic Output Impedance	I <sub>R</sub> = 2mA, f = 120Hz, I <sub>AC</sub> = 0.1I <sub>R</sub>	—	2	—	Ω
e <sub>n</sub>	Noise Voltage	I <sub>R</sub> = 100μA 10Hz < f < 10kHz	—	55	—	μV <sub>RMS</sub>
V <sub>R</sub>	Long Term Stability (non-cumulative)	t = 1000Hrs, I <sub>R</sub> = 100μA	—	—	—	ppm
V <sub>HYST</sub>	Thermal Hysteresis	ΔT = -40°C to +85°C	—	0.08	—	%

**Typical Characteristics**

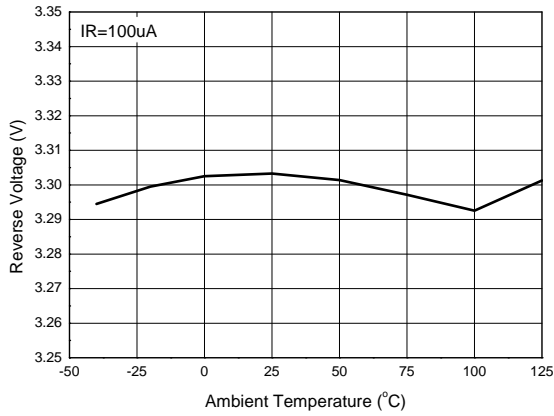

**Reverse Breakdown Voltage Temperature Coefficient**

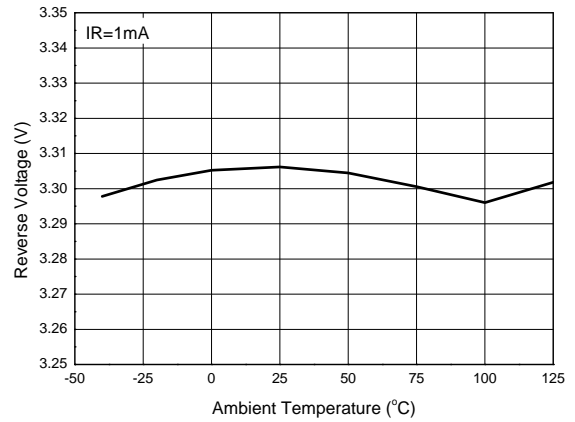

**Reverse Breakdown Voltage Temperature Coefficient**

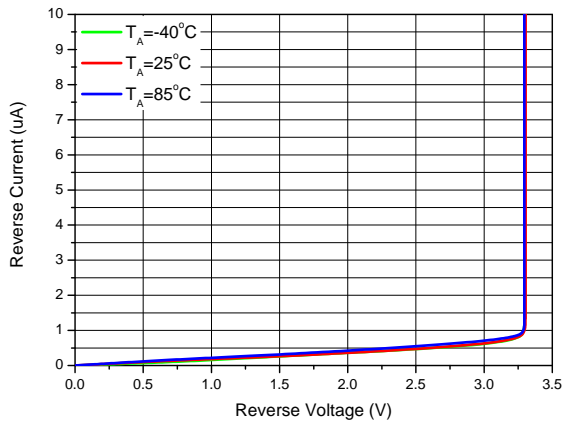

**Minimal Operating Current**

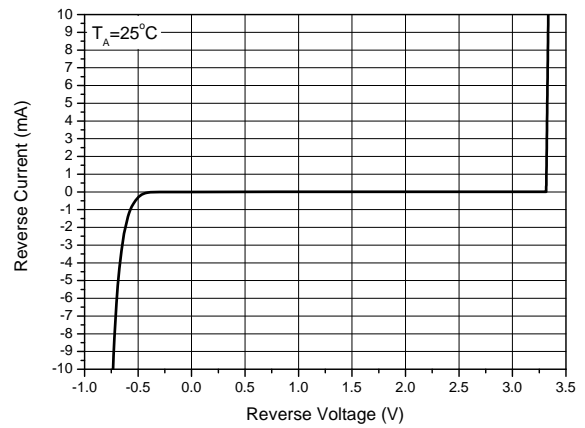

**Reverse Current vs. Reverse Voltage**

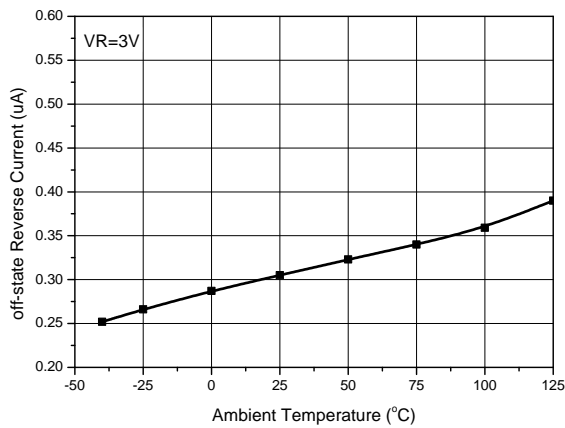

**Off-state Reverse Current vs. Temperature**

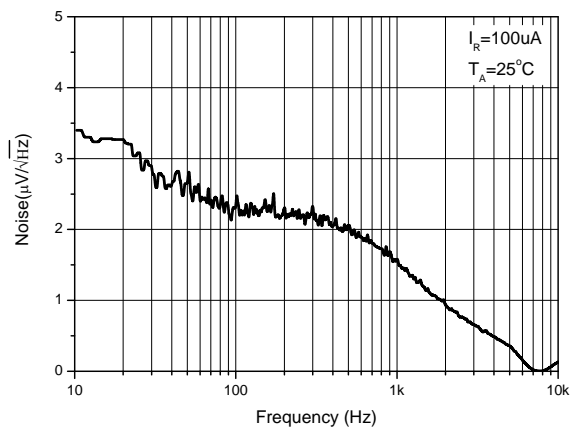

**Noise Voltage vs. Frequency**

**Start-up Characteristics ZXRE330**

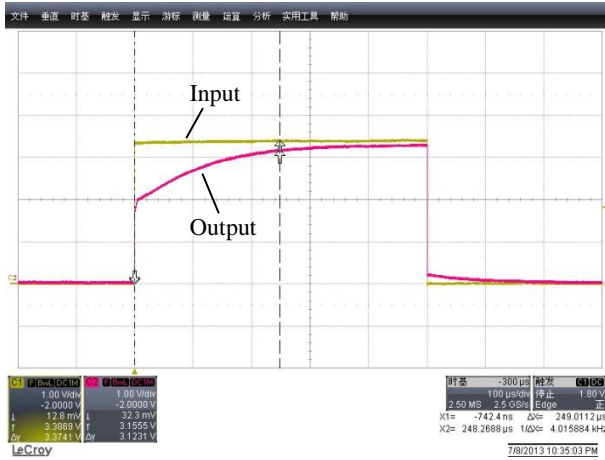

$I_R=100\mu A$ , No Load Capacitor

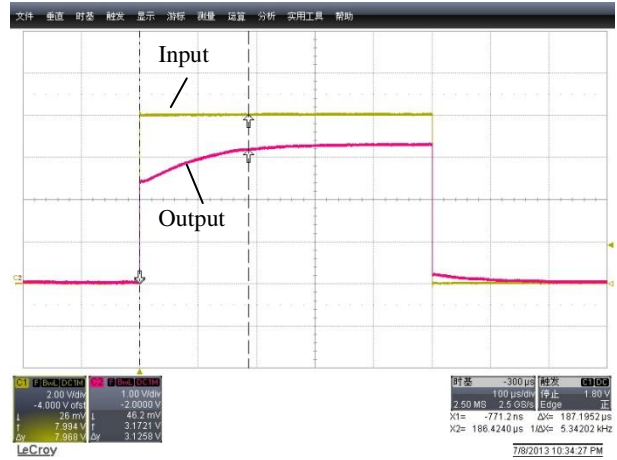

$I_R=5mA$ , No Load Capacitor

**Application Information**

In a conventional shunt regulator application (Figure 1), an external series resistor ( $R_S$ ) is connected between the supply voltage,  $V_S$ , and the ZXRE330.

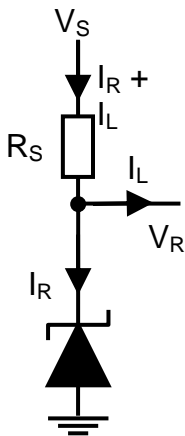

$R_S$  determines the current that flows through the load ( $I_L$ ) and the ZXRE330 ( $I_R$ ). Since load current and supply voltage may vary,  $R_S$  should be small enough to supply at least the minimum acceptable  $I_R$  to the ZXRE330 even when the supply voltage is at its minimum and the load current is at its maximum value. When the supply voltage is at its maximum and  $I_L$  is at its minimum,  $R_S$  should be large enough so that the current flowing through the ZXRE330 is less than 10mA.

$R_S$  is determined by the supply voltage, ( $V_S$ ), the load and operating current, ( $I_L$  and  $I_R$ ), and the ZXRE330's reverse breakdown voltage,  $V_R$ .

$$R_S = \frac{V_S - V_R}{I_L + I_R}$$

**Printed Circuit Board Layout Considerations**

ZXRE330 in the SOT23 package have the die attached to pin 3, which results in an electrical contact between pin 2 and pin 3. Therefore, pin 3 of the SOT23 package must be left floating or connected to pin 2.

ZXRE330 in the TO92 package have the die attached to pin 2, which results in an electrical contact between pin 2 and pin 1. Therefore, pin 2 must be left floating or connected to pin 1.

**Ordering Information**

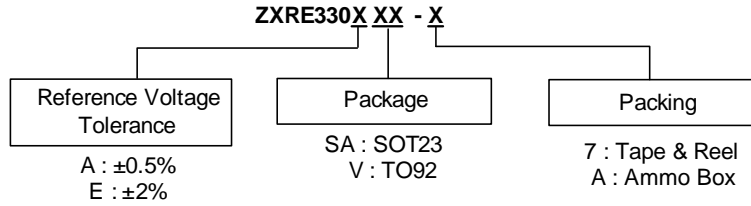

Part Number	Package Code	Packaging	7" Tape and Reel		Ammo Box	
			Quantity	Part Number Suffix	Quantity	Part Number Suffix
ZXRE330ASA-7	SA	SOT23	3,000/Tape & Reel	-7	NA	NA
ZXRE330ESA-7	SA	SOT23	3,000/Tape & Reel	-7	NA	NA
ZXRE330AV-A	V	TO92	NA	NA	2,000/Box	A
ZXRE330EV-A	V	TO92	NA	NA	2,000/Box	A

Note: 5. Pad layout as shown on Diodes Incorporated's package page, which can be found on <http://www.diodes.com/package-outlines.html>.

**Marking Information**

(1) SOT23

( Top View )

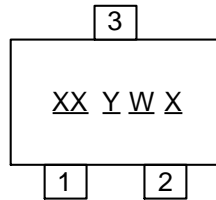

**XX** : Identification code  
**Y** : Year 0~9  
**W** : Week : A~Z : 1~26 week;  
 a~z : 27~52 week; z represents 52 and 53 week  
**X** : Internal Code

Part Number	Package	Identification Code
ZXRE330ASA-7	SOT23	DC
ZXRE330ESA-7	SOT23	DD

(2) TO92

( Top View )

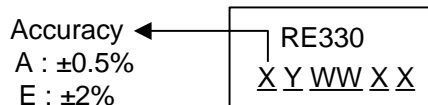

**Y** : Year : 0~9  
**WW** : Week : 01~52; 52 represents 52 and 53 week  
**XX** : Internal Code

**Package Outline Dimensions**

Please see <http://www.diodes.com/package-outlines.html> for the latest version.

**SOT23**

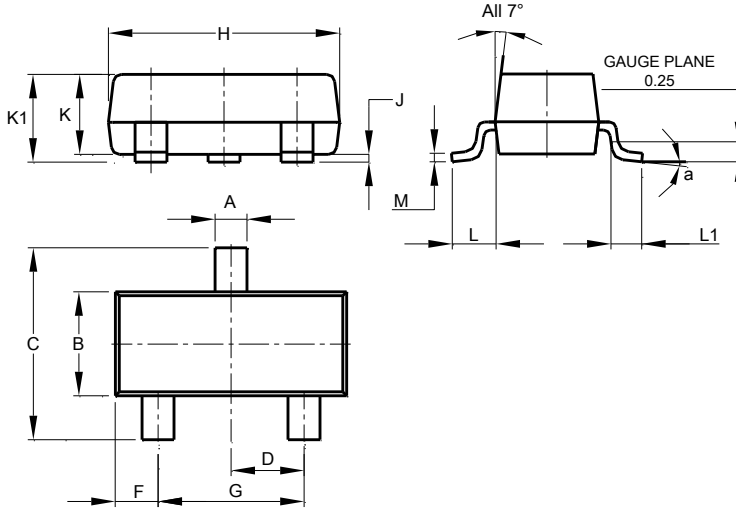

SOT23			
Dim	Min	Max	Typ
A	0.37	0.51	0.40
B	1.20	1.40	1.30
C	2.30	2.50	2.40
D	0.89	1.03	0.915
F	0.45	0.60	0.535
G	1.78	2.05	1.83
H	2.80	3.00	2.90
J	0.013	0.10	0.05
K	0.890	1.00	0.975
K1	0.903	1.10	1.025
L	0.45	0.61	0.55
L1	0.25	0.55	0.40
M	0.085	0.150	0.110
a	0°	8°	--
All Dimensions in mm			

**TO92**

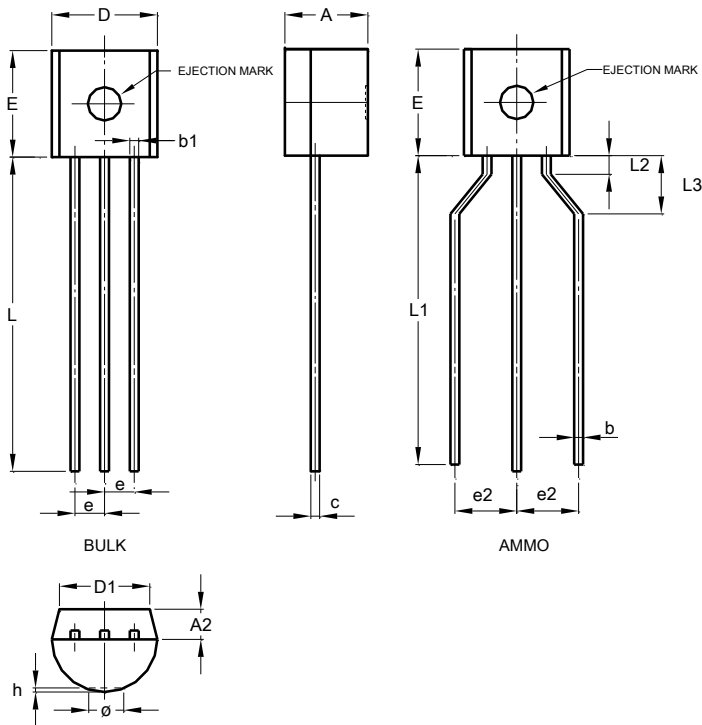

TO92			
Dim	Min	Max	Typ
A	3.45	3.66	-
A2	1.22	1.37	-
b	-	-	0.38
c	-	-	0.38
D	4.27	4.78	-
D1	-	-	3.87
E	4.32	4.83	-
e	-	-	1.27
e2	2.40	2.90	-
L	12.98	15.00	-
L1	12.80	15.00	-
L2	0.80	-	-
L3	2.00	3.00	-
All Dimensions in mm			

## Suggested Pad Layout

Please see <http://www.diodes.com/package-outlines.html> for the latest version.

SOT23

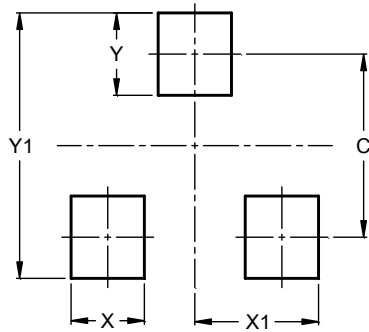

Dimensions	Value (in mm)
C	2.0
X	0.8
X1	1.35
Y	0.9
Y1	2.9



**IMPORTANT NOTICE**

DIODES INCORPORATED MAKES NO WARRANTY OF ANY KIND, EXPRESS OR IMPLIED, WITH REGARDS TO THIS DOCUMENT, INCLUDING, BUT NOT LIMITED TO, THE IMPLIED WARRANTIES OF MERCHANTABILITY AND FITNESS FOR A PARTICULAR PURPOSE (AND THEIR EQUIVALENTS UNDER THE LAWS OF ANY JURISDICTION).

Diodes Incorporated and its subsidiaries reserve the right to make modifications, enhancements, improvements, corrections or other changes without further notice to this document and any product described herein. Diodes Incorporated does not assume any liability arising out of the application or use of this document or any product described herein; neither does Diodes Incorporated convey any license under its patent or trademark rights, nor the rights of others. Any Customer or user of this document or products described herein in such applications shall assume all risks of such use and will agree to hold Diodes Incorporated and all the companies whose products are represented on Diodes Incorporated website, harmless against all damages.

Diodes Incorporated does not warrant or accept any liability whatsoever in respect of any products purchased through unauthorized sales channel. Should Customers purchase or use Diodes Incorporated products for any unintended or unauthorized application, Customers shall indemnify and hold Diodes Incorporated and its representatives harmless against all claims, damages, expenses, and attorney fees arising out of, directly or indirectly, any claim of personal injury or death associated with such unintended or unauthorized application.

Products described herein may be covered by one or more United States, international or foreign patents pending. Product names and markings noted herein may also be covered by one or more United States, international or foreign trademarks.

This document is written in English but may be translated into multiple languages for reference. Only the English version of this document is the final and determinative format released by Diodes Incorporated.

**LIFE SUPPORT**

Diodes Incorporated products are specifically not authorized for use as critical components in life support devices or systems without the express written approval of the Chief Executive Officer of Diodes Incorporated. As used herein:

A. Life support devices or systems are devices or systems which:

1. are intended to implant into the body, or
2. support or sustain life and whose failure to perform when properly used in accordance with instructions for use provided in the labeling can be reasonably expected to result in significant injury to the user.

B. A critical component is any component in a life support device or system whose failure to perform can be reasonably expected to cause the failure of the life support device or to affect its safety or effectiveness.

Customers represent that they have all necessary expertise in the safety and regulatory ramifications of their life support devices or systems, and acknowledge and agree that they are solely responsible for all legal, regulatory and safety-related requirements concerning their products and any use of Diodes Incorporated products in such safety-critical, life support devices or systems, notwithstanding any devices- or systems-related information or support that may be provided by Diodes Incorporated. Further, Customers must fully indemnify Diodes Incorporated and its representatives against any damages arising out of the use of Diodes Incorporated products in such safety-critical, life support devices or systems.

Copyright © 2018, Diodes Incorporated

[www.diodes.com](http://www.diodes.com)

单击下面可查看定价，库存，交付和生命周期等信息

[>>Diodes Incorporated\(达尔科技\)](#)