

Description

The 74LVC2G08 is a dual, two input AND gate. Both gates have push-pull outputs designed for operation over a power supply range of 1.65V to 5.5V. The device is fully specified for partial power down applications using I_{OFF}. The I_{OFF} circuitry disables the output, preventing damaging current backflow when the device is powered down. Each gate performs the positive Boolean function:

$$Y = A \bullet B \text{ or } Y = \overline{\overline{A} + \overline{B}}$$

Pin Assignments

(Top View)

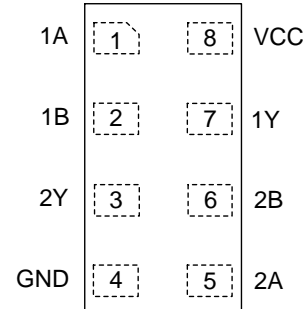

X2-DFN2010-8
X2-DFN1410-8
X2-DFN1210-8

Features

- Wide Supply Voltage Range from 1.65 to 5.5V
- ± 24mA Output Drive at 3.3V
- CMOS low power consumption
- I_{OFF} Supports Partial-Power-Down Mode Operation
- Inputs accept up to 5.5V
- Schmitt Trigger Action at all inputs makes the circuit tolerant for slower input rise and fall times. The hysteresis is typically 100mV at V_{CC} = 3.0V.
- ESD Protection Exceeds JESD 22
 - 2000-V Human Body Model (A114)
 - Exceeds 1000-V Charged Device Model (C101)
- Latch-Up Exceeds 100mA per JESD 78, Class I
- **Totally Lead-Free & Fully RoHS Compliant (Notes 1 & 2)**
- **Halogen and Antimony Free. "Green" Device (Note 3)**

Applications

- Voltage Level Shifting
- General Purpose Logic
- Power Down Signal Isolation
- Wide Array of Products Such as:
 - PCs, Networking, Notebooks, Netbooks, PDAs
 - Tablet Computers, E-readers
 - Computer Peripherals, Hard Drives, CD/DVD ROMs
 - TVs, DVDs, DVRs, Set Top Boxes
 - Cell Phones, Personal Navigation / GPS
 - MP3 Players, Cameras, Video Recorders

Notes:

1. No purposely added lead. Fully EU Directive 2002/95/EC (RoHS) & 2011/65/EU (RoHS 2) compliant.
2. See http://www.diodes.com/quality/lead_free.html for more information about Diodes Incorporated's definitions of Halogen- and Antimony-free, "Green" and Lead-free.
3. Halogen- and Antimony-free "Green" products are defined as those which contain <900ppm bromine, <900ppm chlorine (<1500ppm total Br + Cl) and <1000ppm antimony compounds.

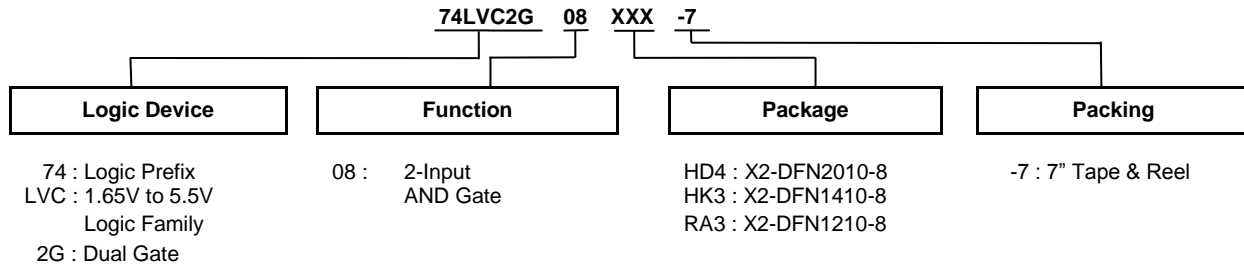
Ordering Information (Note 4)

Device	Package Code	Package (Note 5)	Package Size	7" Tape and Reel (Note 6)	
				Quantity	Part Number Suffix
74LVC2G08HD4-7	HD4	X2-DFN2010-8	1.95mm x 1.0mm x 0.4mm 0.5 mm lead pitch	5,000/Tape & Reel	-7
74LVC2G08HK3-7	HK3	X2-DFN1410-8	1.35mm x 1.0mm x 0.35mm 0.4 mm lead pitch	5,000/Tape & Reel	-7
74LVC2G08RA3-7	RA3	X2-DFN1210-8	1.2mm x 1.0mm x 0.35mm 0.3 mm lead pitch	5,000/Tape & Reel	-7

- Notes: 4. For packaging details, go to our website at <http://www.diodes.com/products/packages.html>.
5. Pad layout as shown in Diodes Incorporated's package outline PDFs, which can be found on our website at <http://www.diodes.com/package-outlines.html>.
6. The taping orientation is located on our website at <http://www.diodes.com/datasheets/ap02007.pdf>.

Pin Descriptions

Pin Name	Pin No.	Description
1A	1	Data Input
1B	2	Data Input
2Y	3	Data Output
GND	4	Ground
2A	5	Data Input
2B	6	Data Input
1Y	7	Data Output
V _{CC}	8	Supply Voltage

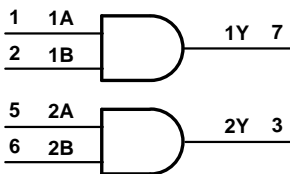
Logic Diagram

Function Table

Inputs		Output
A	B	Y
L	L	L
L	H	L
H	L	L
H	H	H

Absolute Maximum Ratings (Notes 7 & 8)

Symbol	Description	Rating	Unit
ESD HBM	Human Body Model ESD Protection	2	kV
ESD CDM	Charged Device Model ESD Protection	1	kV
V _{CC}	Supply Voltage	-0.5 to +6.5	V
V _I	Input Voltage	-0.5 to +6.5	V
V _O	Output Voltage -Active Mode	-0.5 to V _{CC} +0.5	V
	Output Voltage Power Down Mode	-0.5 to +6.5	V
I _{IK}	Input Clamp Current V _I <0	-50	mA
I _{OK}	Output Clamp Current (V _O < 0 OR V _O > V _{CC})	±50	mA
I _O	Continuous Output Current (V _O = 0 to V _{CC})	±50	mA
I _{CC}	Continuous Current Through V _{CC}	100	mA
I _{GND}	Continuous Current Through GND	-100	mA
T _J	Operating Junction Temperature	-40 to +150	°C
T _{STG}	Storage Temperature	-65 to +150	°C

- Notes:
- Stresses beyond the absolute maximum may result in immediate failure or reduced reliability. These are stress values and device operation should be within recommend values.
 - Forcing the maximum allowed voltage could cause a condition exceeding the maximum current or conversely forcing the maximum current could cause a condition exceeding the maximum voltage. The ratings of both current and voltage must be maintained within the controlled range.

Recommended Operating Conditions (Note 9)

Symbol	Parameter		Min	Max	Unit
V _{CC}	Operating Voltage	Operating	1.65	5.5	V
		Data Retention Only	1.5	—	
V _I	Input Voltage		0	5.5	V
V _O	Output Voltage Active Mode		0	V _{CC}	V
	Output Voltage Power-Down Mode		0	5.5	
I _{OH}	High-Level Output Current	V _{CC} = 1.65V	—	-4	mA
		V _{CC} = 2.3V	—	-8	
		V _{CC} = 2.7V	—	-12	
		V _{CC} = 3.0V	—	-16	
		V _{CC} = 4.5V	—	-24	
I _{OL}	Low-Level Output Current	V _{CC} = 1.65V	—	4	mA
		V _{CC} = 2.3V	—	8	
		V _{CC} = 2.7V	—	12	
		V _{CC} = 3.0V	—	16	
		V _{CC} = 4.5V	—	32	
Δt/ΔV	Input Transition Rise or Fall Rate	V _{CC} = 1.65V to 2.7V	—	20	ns/V
		V _{CC} = 2.7V to 5.5V	—	10	
T _A	Operating Free-Air Temperature		-40	+125	°C

Note: 9. Unused inputs should be held at V_{CC} or Ground.

Electrical Characteristics (All typical values are at $T_A = +25^\circ\text{C}$)

Symbol	Parameter	Test Conditions	V_{CC}	-40°C to +85°C			-40°C to +125°C		Unit
				Min	Typ.	Max	Min	Max	
V_{IH}	High-Level Input Voltage	—	$V_{CC} = 1.65\text{V to } 1.95\text{V}$	$0.65 \times V_{CC}$	—	—	$0.65 \times V_{CC}$	—	V
			$V_{CC} = 2.3\text{V to } 2.7\text{V}$	1.7	—	—	1.7	—	
			$V_{CC} = 2.7\text{V to } 3.6\text{V}$	2.0	—	—	2.0	—	
			$V_{CC} = 4.5\text{V to } 5.5\text{V}$	$0.7 \times V_{CC}$	—	—	$0.7 \times V_{CC}$	—	
V_{IL}	Low-Level Input Voltage	—	$V_{CC} = 1.65\text{V to } 1.95\text{V}$	—	—	$0.35 \times V_{CC}$	—	$0.35 \times V_{CC}$	V
			$V_{CC} = 2.3\text{V to } 2.7\text{V}$	—	—	0.7	—	0.7	
			$V_{CC} = 2.7\text{V to } 3.6\text{V}$	—	—	0.8	—	0.8	
			$V_{CC} = 4.5\text{V to } 5.5\text{V}$	—	—	$0.3 \times V_{CC}$	—	$0.3 \times V_{CC}$	
V_{OH}	High-Level Output Voltage	$I_{OH} = -100\mu\text{A}$	1.65V to 5.5V	$V_{CC} - 0.1$	V_{CC}	—	$V_{CC} - 0.1$	—	V
		$I_{OH} = -4\text{mA}$	1.65V	1.2	1.53	—	0.95	—	
		$I_{OH} = -8\text{mA}$	2.3V	1.9	2.13	—	1.7	—	
		$I_{OH} = -12\text{mA}$	2.7	2.2	2.5	—	1.9	—	
		$I_{OH} = -16\text{mA}$	3V	2.4	2.7	—	2.2	—	
		$I_{OH} = -24\text{mA}$		2.3	2.6	—	2.0	—	
		$I_{OH} = -32\text{mA}$	4.5V	3.8	4.1	—	3.4	—	
V_{OL}	Low-Level Output Voltage	$I_{OL} = 100\mu\text{A}$	1.65V to 5.5V	—	0	0.1	—	0.1	V
		$I_{OL} = 4\text{mA}$	1.65V	—	0.08	0.45	—	0.7	
		$I_{OL} = 8\text{mA}$	2.3V	—	0.14	0.3	—	0.45	
		$I_{OL} = 12\text{mA}$	2.7V	—	0.19	0.4	—	0.6	
		$I_{OL} = 16\text{mA}$	3V	—	0.25	0.4	—	0.6	
		$I_{OL} = 24\text{mA}$		—	0.37	0.55	—	0.8	
		$I_{OL} = 32\text{mA}$	4.5V	—	0.43	0.55	—	0.8	
I_I	Input Current	$V_I = 5.5\text{V or GND}$	0V to 5.5V	—	± 0.1	± 5	—	± 20	μA
I_{OFF}	Power Down Leakage Current	$V_I \text{ or } V_O = 5.5\text{V}$	0V	—	± 0.1	± 10	—	± 20	μA
I_{CC}	Supply Current	$V_I = 5.5\text{V or GND}$ $I_O = 0\text{A}$	1.65V to 5.5V	—	0.1	10	—	40	μA
ΔI_{CC}	Additional Supply Current	One input at $V_{CC} - 0.6\text{V}$ Other inputs at V_{CC} or GND	2.3V to 5.5V	—	5	500	—	5,000	μA
C_I	Input Capacitance	$V_I = V_{CC} \text{ or GND}$	3.3V	—	2.5	—	—	—	pF

Operating Characteristics

Parameter		Test Conditions	V _{CC} = 1.8V	V _{CC} = 2.5V	V _{CC} = 3.3V	V _{CC} = 5V	Unit
			Typ.	Typ.	Typ.	Typ.	
C _{pd}	Power Dissipation Capacitance	f = 10MHz	17	17	17	20	pF

Package Characteristics

Symbol	Parameter	Package	Test Conditions	Min	Typ.	Max	Unit
θ _{JA}	Thermal Resistance Junction-to-Ambient	X2-DFN2010-8	(Note 10)	—	313	—	°C/W
		X2-DFN1410-8		—	321	—	
		X2-DFN1210-8		—	395	—	
θ _{JC}	Thermal Resistance Junction-to-Case	X2-DFN2010-8	(Note 10)	—	145	—	°C/W
		X2-DFN1410-8		—	166	—	
		X2-DFN1210-8		—	236	—	

Note: 10. Test condition for each package type: Device mounted on FR-4 substrate PC board, 2oz copper, with minimum recommended pad layout.

Switching Characteristics

Typical Values at T_A = +25°C and nominal voltages 1.8V, 2.5V, 2.7V, 3.3V, and 5.0V. See Figure 1.

Parameter	From Input	To Output	V _{CC}	T _A = -40°C to +85°C			T _A = -40°C to +125°C		Unit
				Min	Typ	Max	Min	Max	
t _{pd}	A or B	Y	1.8V ± 0.15V	1.0	3.2	9.0	1.0	11.3	ns
			2.5V ± 0.2V	0.5	2.2	5.1	0.5	6.4	
			2.7V	1.0	2.5	5.3	1.0	6.7	
			3.3V ± 0.3V	0.5	2.1	4.7	0.5	5.9	
			5.0V ± 0.5V	0.5	1.7	3.8	0.5	4.8	

Parameter Measurement Information

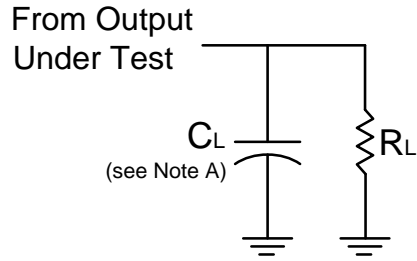

V_{CC}	Inputs		V_M	C_L	R_L
	V_I	t_r/t_f			
$1.8V \pm 0.15V$	V_{CC}	$\leq 2ns$	$V_{CC}/2$	30pF	1k Ω
$2.5V \pm 0.2V$	V_{CC}	$\leq 2ns$	$V_{CC}/2$	30pF	500 Ω
2.7V	2.7V	$\leq 2.5ns$	1.5V	50pF	500 Ω
$3.3V \pm 0.3V$	2.7V	$\leq 2.5ns$	1.5V	50pF	500 Ω
$5.0V \pm 0.5V$	V_{CC}	$\leq 2.5ns$	$V_{CC}/2$	50pF	500 Ω

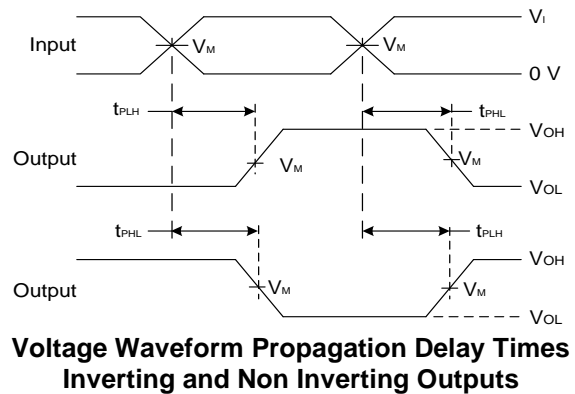
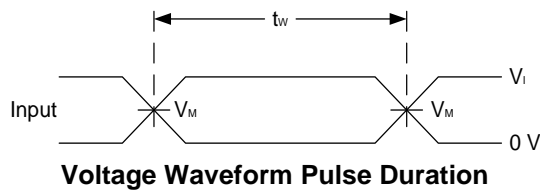
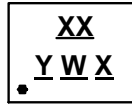

Figure 1. Load Circuit and Voltage Waveforms

- Notes:
- A. Includes test lead and test apparatus capacitance.
 - B. All pulses are supplied at pulse repetition rate $\leq 10MHz$.
 - C. Inputs are measured separately one transition per measurement.
 - D. t_{PLH} and t_{PHL} are the same as t_{pd} .

Marking Information

(Top View)



XX : Identification Code
Y : Year : 0~9
W : Week : A~Z : 1~26 week;
 a~z : 27~52 week; z represents
 52 and 53 week
X : Internal Code

Part Number	Package	Identification Code
74LVC2G08HD4-7	X2-DFN2010-8	9E
74LVC2G08HK3-7	X2-DFN1410-8	9F
74LVC2G08RA3-7	X2-DFN1210-8	9G

X2-DFN1210-8 Package Outline Dimensions

Please see <http://www.diodes.com/package-outlines.html> for the latest version.

X2-DFN1210-8

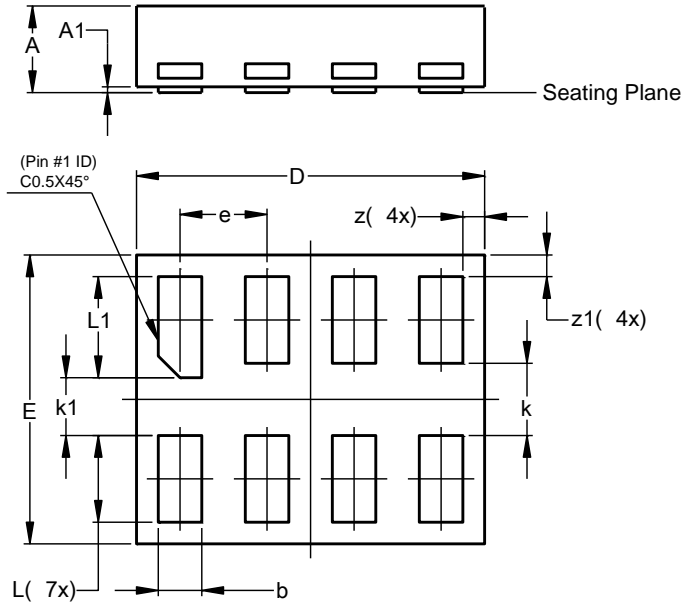

X2-DFN1210-8			
Dim	Min	Max	Typ
A	-	0.35	0.30
A1	0	0.03	0.02
b	0.10	0.20	0.15
D	1.15	1.25	1.20
E	0.95	1.05	1.00
e	-	-	0.30
k	-	-	0.25
k1	-	-	0.20
L	0.25	0.35	0.30
L1	0.30	0.40	0.35
z	0.050	0.100	0.075
z1	0.050	0.100	0.075
All Dimensions in mm			

Suggested Pad Layout

Please see <http://www.diodes.com/package-outlines.html> for the latest version.

X2-DFN1210-8

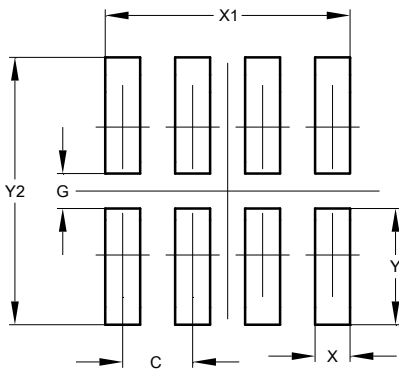

Dimensions	Value (in mm)
C	0.300
G	0.150
X	0.150
X1	1.050
Y	0.500
Y1	1.150

X2-DFN1410-8 Package Outline Dimensions

Please see <http://www.diodes.com/package-outlines.html> for the latest version.

X2-DFN1410-8



X2-DFN1410-8			
Dim	Min	Max	Typ
A	0.30	0.35	0.33
A1	0.00	0.03	0.02
A3	--	--	0.10
b	0.12	0.20	0.15
D	1.30	1.40	1.35
E	0.95	1.05	1.00
e	--	--	0.35
e1	--	--	0.55
L	0.27	0.35	0.30
L1	0.32	0.40	0.35
All Dimensions in mm			

Suggested Pad Layout

Please see <http://www.diodes.com/package-outlines.html> for the latest version.

X2-DFN1410-8

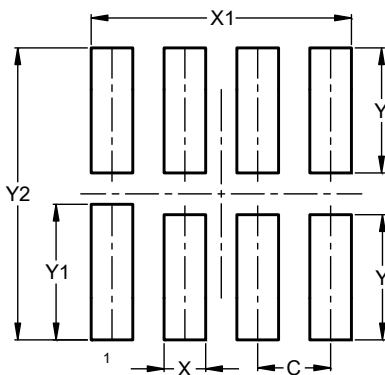

Dimensions	Value (in mm)
C	0.350
X	0.200
X1	1.250
Y	0.600
Y1	0.650
Y2	1.400

X2-DFN2010-8 Package Outline Dimensions

Please see <http://www.diodes.com/package-outlines.html> for the latest version.

X2-DFN2010-8

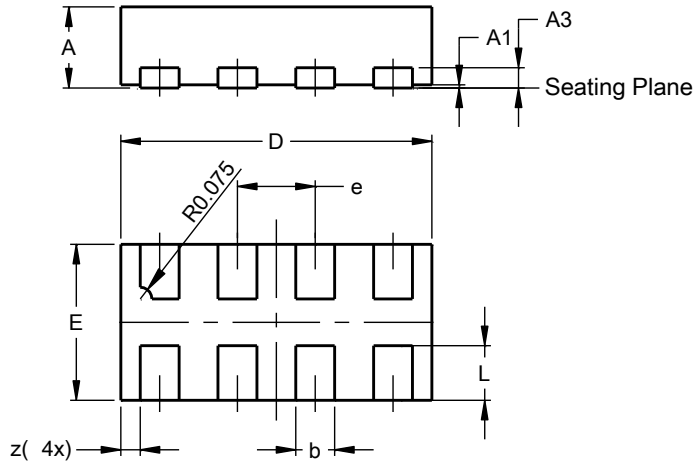

X2-DFN2010-8			
Dim	Min	Max	Typ
A	--	0.40	--
A1	0.00	0.05	0.02
A3	--	--	0.13
b	0.20	0.30	0.25
D	1.950	2.05	2.00
E	0.95	1.05	1.00
e	--	--	0.50
L	0.30	0.40	0.35
z	--	--	0.125
All Dimensions in mm			

Suggested Pad Layout

Please see <http://www.diodes.com/package-outlines.html> for the latest version.

X2-DFN2010-8

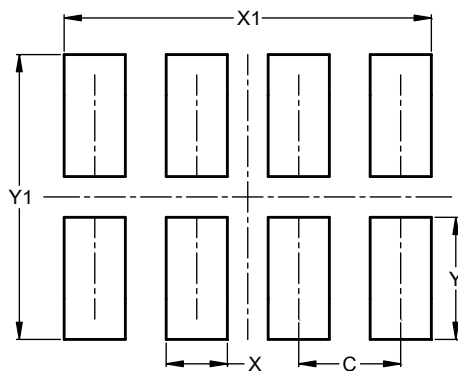

Dimensions	Value (in mm)
C	0.500
X	0.300
X1	1.800
Y	0.600
Y1	1.400

IMPORTANT NOTICE

DIODES INCORPORATED MAKES NO WARRANTY OF ANY KIND, EXPRESS OR IMPLIED, WITH REGARDS TO THIS DOCUMENT, INCLUDING, BUT NOT LIMITED TO, THE IMPLIED WARRANTIES OF MERCHANTABILITY AND FITNESS FOR A PARTICULAR PURPOSE (AND THEIR EQUIVALENTS UNDER THE LAWS OF ANY JURISDICTION).

Diodes Incorporated and its subsidiaries reserve the right to make modifications, enhancements, improvements, corrections or other changes without further notice to this document and any product described herein. Diodes Incorporated does not assume any liability arising out of the application or use of this document or any product described herein; neither does Diodes Incorporated convey any license under its patent or trademark rights, nor the rights of others. Any Customer or user of this document or products described herein in such applications shall assume all risks of such use and will agree to hold Diodes Incorporated and all the companies whose products are represented on Diodes Incorporated website, harmless against all damages.

Diodes Incorporated does not warrant or accept any liability whatsoever in respect of any products purchased through unauthorized sales channel.

Should Customers purchase or use Diodes Incorporated products for any unintended or unauthorized application, Customers shall indemnify and hold Diodes Incorporated and its representatives harmless against all claims, damages, expenses, and attorney fees arising out of, directly or indirectly, any claim of personal injury or death associated with such unintended or unauthorized application.

Products described herein may be covered by one or more United States, international or foreign patents pending. Product names and markings noted herein may also be covered by one or more United States, international or foreign trademarks.

This document is written in English but may be translated into multiple languages for reference. Only the English version of this document is the final and determinative format released by Diodes Incorporated.

LIFE SUPPORT

Diodes Incorporated products are specifically not authorized for use as critical components in life support devices or systems without the express written approval of the Chief Executive Officer of Diodes Incorporated. As used herein:

A. Life support devices or systems are devices or systems which:

1. are intended to implant into the body, or
2. support or sustain life and whose failure to perform when properly used in accordance with instructions for use provided in the labeling can be reasonably expected to result in significant injury to the user.

B. A critical component is any component in a life support device or system whose failure to perform can be reasonably expected to cause the failure of the life support device or to affect its safety or effectiveness.

Customers represent that they have all necessary expertise in the safety and regulatory ramifications of their life support devices or systems, and acknowledge and agree that they are solely responsible for all legal, regulatory and safety-related requirements concerning their products and any use of Diodes Incorporated products in such safety-critical, life support devices or systems, notwithstanding any devices- or systems-related information or support that may be provided by Diodes Incorporated. Further, Customers must fully indemnify Diodes Incorporated and its representatives against any damages arising out of the use of Diodes Incorporated products in such safety-critical, life support devices or systems.

Copyright © 2016, Diodes Incorporated

www.diodes.com

单击下面可查看定价，库存，交付和生命周期等信息

[>>Diodes Incorporated\(达尔科技\)](#)