

### Features

- Glass Passivated Die Construction
- Super-Fast Recovery Time For High Efficiency
- Low Forward Voltage Drop and High Current Capability
- Surge Overload Rating to 35A Peak
- Ideally Suited for Automated Assembly
- **Lead Free Finish, RoHS Compliant (Note 5)**

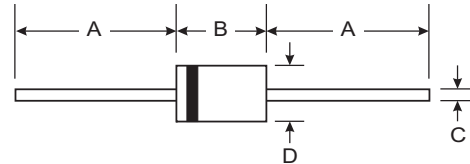

### Mechanical Data

- Case: DO-41
- Case Material: Molded Plastic. UL Flammability Classification Rating 94V-0
- Moisture Sensitivity: Level 1 per J-STD-020C
- Terminals: Finish — Bright Tin. Solderable per MIL-STD-202, Method 208
- Marking: MUR140: R140  
MUR160: R160
- Polarity: Cathode Band
- Mounting Position: Any
- Weight: 0.35 grams (approximate)

DO-41 Plastic		
Dim	Min	Max
A	25.40	—
B	4.06	5.21
C	0.71	0.864
D	2.00	2.72
All Dimensions in mm		

### Maximum Ratings and Electrical Characteristics

@  $T_A = 25^\circ\text{C}$  unless otherwise specified

Single phase, half wave, 60Hz, resistive or inductive load.  
For capacitive load, derate current by 20%.

Characteristic	Symbol	MUR140	MUR160	Unit
Peak Repetitive Reverse Voltage Working Peak Reverse Voltage DC Blocking Voltage	$V_{RRM}$ $V_{RWM}$ $V_R$	400	600	V
RMS Reverse Voltage	$V_{R(RMS)}$	283	424	V
Average Rectified Output Current @ $T_J = 120^\circ\text{C}$	$I_O$	1.0		A
Non-Repetitive Peak Forward Surge Current 8.3ms Single half sine-wave Superimposed on Rated Load (JEDEC Method)	$I_{FSM}$	35		A
Forward Voltage @ $I_F = 1.0\text{A}$ , $T_J = 25^\circ\text{C}$ @ $I_F = 1.0\text{A}$ , $T_J = 150^\circ\text{C}$	$V_{FM}$	1.25 1.05		V
Peak Reverse Current at Rated DC Blocking Voltage @ $T_A = 25^\circ\text{C}$ @ $T_A = 150^\circ\text{C}$	$I_{RM}$	5.0 150		$\mu\text{A}$
Reverse Recovery Time (Note 2)	$t_{rr}$	50		ns
Reverse Recovery Time (Note 3)	$t_{rr}$	75		ns
Forward Recovery Time (Note 4)	$t_{fr}$	50		ns
Typical Junction Capacitance (Note 1)	$C_j$	45		pF
Typical Thermal Resistance, Junction to Ambient	$R_{\theta JA}$	72		K/W
Operating and Storage Temperature Range	$T_J$ , $T_{STG}$	-65 to +175		$^\circ\text{C}$

- Notes:
1. Measured at 1.0MHz and applied reverse voltage of 0V DC.
  2. Measured with  $I_F = 0.5\text{A}$ ,  $I_R = 1.0\text{A}$ ,  $I_{rr} = 0.25\text{A}$ . See Figure 5.
  3. Measured with  $I_F = 1\text{A}$ ,  $di/dt = 50\text{A}/\mu\text{s}$ .
  4. Measured with  $I_F = 1.0\text{A}$ ,  $di/dt = 100\text{A}/\mu\text{s}$ , Duty Cycle  $\leq 2.0\%$ .
  5. RoHS revision 13.2.2003. Glass and High Temperature Solder Exemptions Applied, see *EU Directive Annex Notes 5 and 7*.

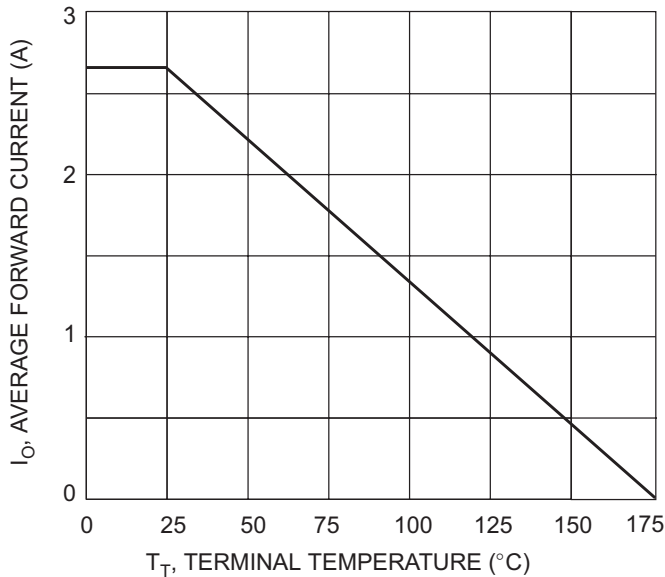

Fig. 1 Forward Current Derating Curve

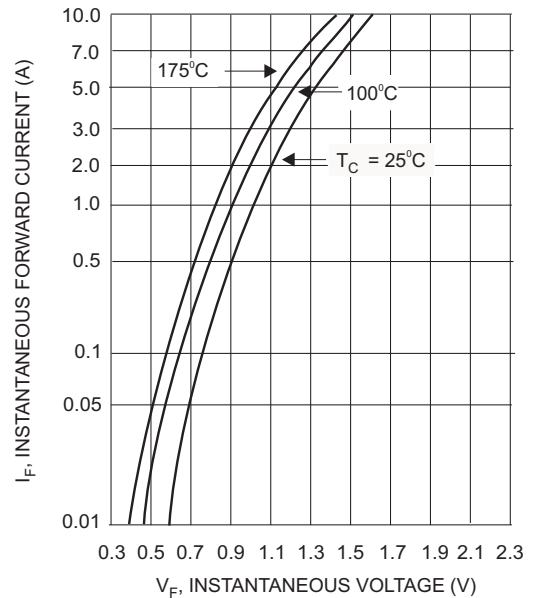

Fig. 2 Typical Forward Current

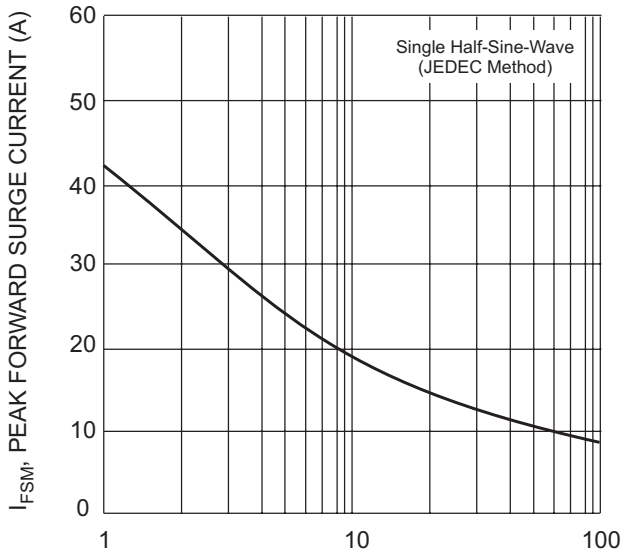

Fig. 3 Surge Current Derating Curve

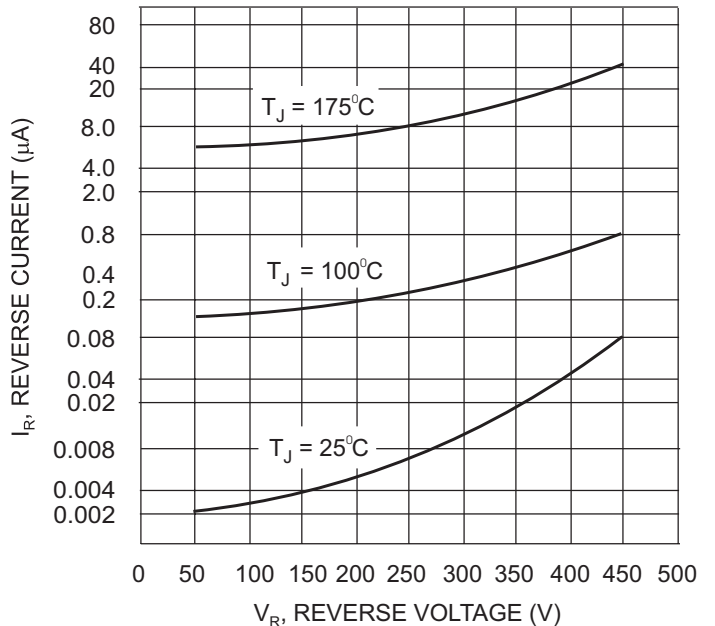
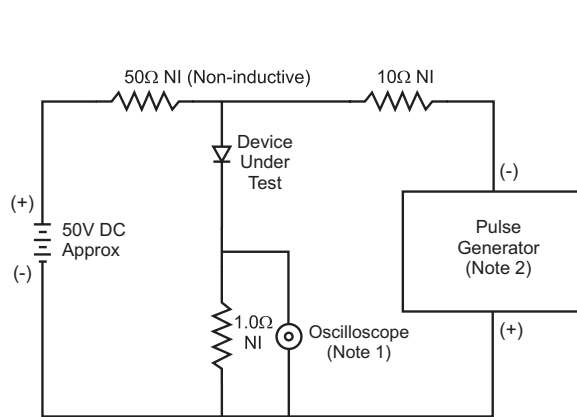
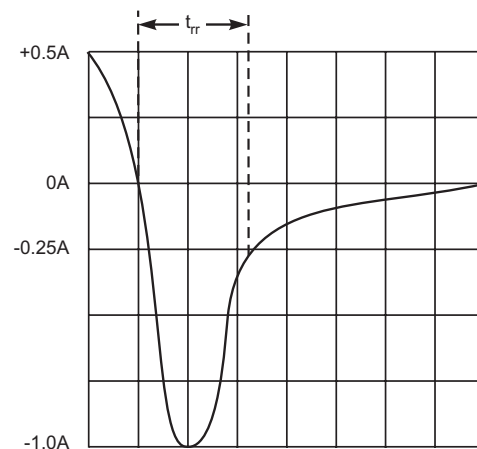

Fig. 4 Typical Reverse Current



- Notes:
1. Rise Time = 7.0ns max. Input Impedance = 1.0MΩ, 22pF.
  2. Rise Time = 10ns max. Input Impedance = 50Ω.



Set time base for 50/100 ns/cm

Fig. 5 Reverse Recovery Time Characteristic and Test Circuit

**Ordering Information** (Note 6)

<b>Device</b>	<b>Packaging</b>	<b>Shipping</b>
MUR140-A	DO-41	5K/Ammo Pack
MUR140-B	DO-41	1K/Bulk
MUR140-T	DO-41	5K/Tape & Reel, 13-inch
MUR160-A	DO-41	5K/Ammo Pack
MUR160-B	DO-41	1K/Bulk
MUR160-T	DO-41	5K/Tape & Reel, 13-inch

Notes: 6. For packaging details, visit our website at <http://www.diodes.com/datasheets/ap02008.pdf>

单击下面可查看定价，库存，交付和生命周期等信息

[>>Diodes Incorporated\(达达科技\(美台\)\)](#)